

MINIMA®

# FORMES OPTIQUES

OPTICAL SHAPES  
FORMAS ÓPTICAS  
OPTISCHE FORMEN  
FORMAS ÓPTICAS

FORMES OPTIQUES  
OPTICAL SHAPES  
FORMAS ÓPTICAS  
OPTISCHE FORMEN  
FORMAS ÓPTICAS

M-22

Collection "VIS"  
"SCREWS" collection

Pont à vis  
Bridge with screws  
Pont P ou Pont W  
avec selle clipsée  
P bridge or W bridge  
with clipped saddle

Pont W nu  
W bridge bare

Pont à cavaliers  
Plug fit system bridge

Collection "CAVALIERS"  
"WHITOUT SCREWS" collection  
M-10

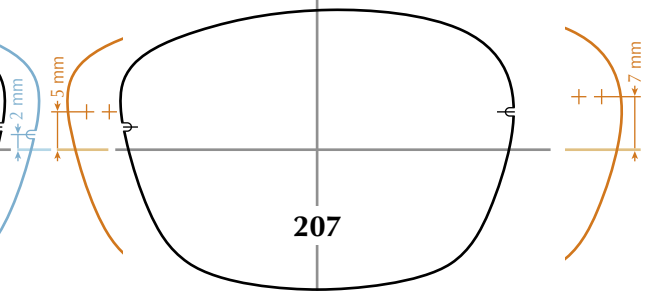
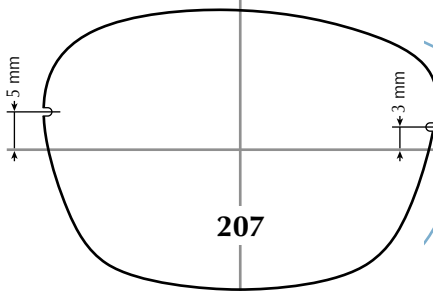
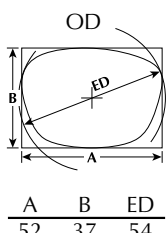
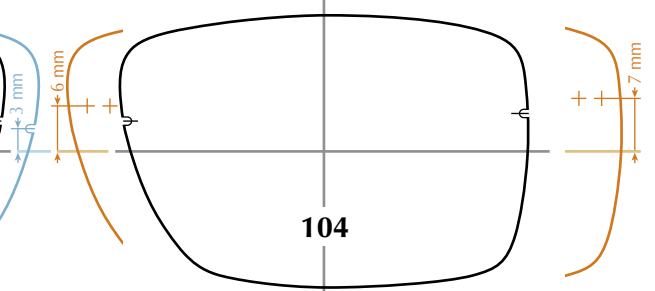
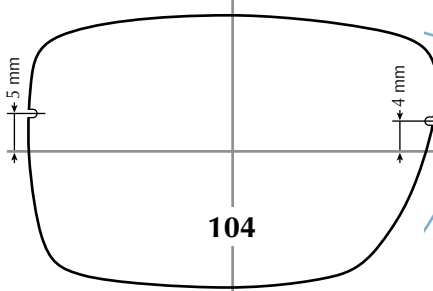
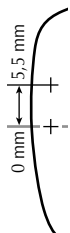
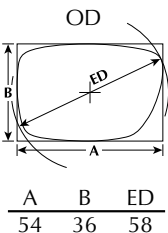
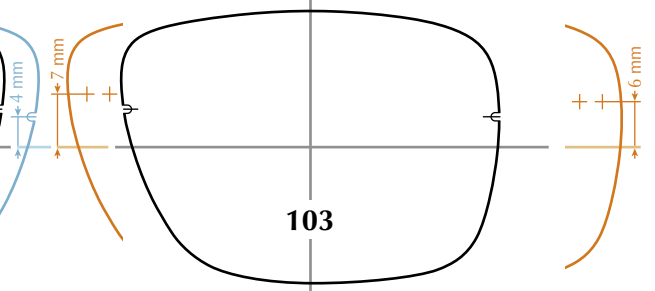
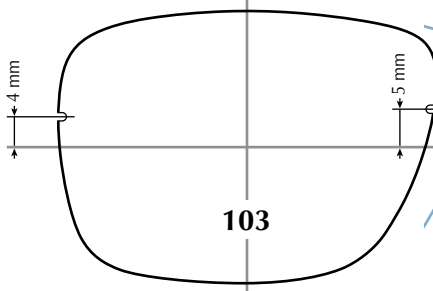
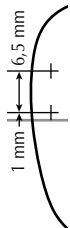
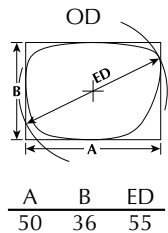
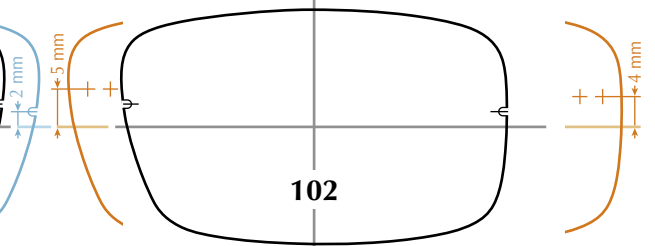
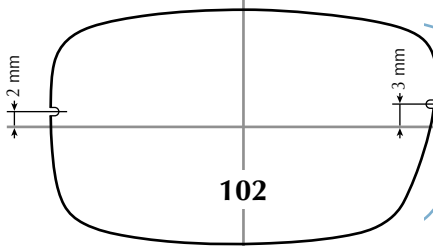
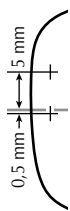
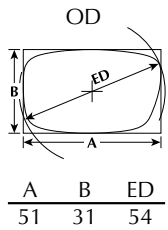
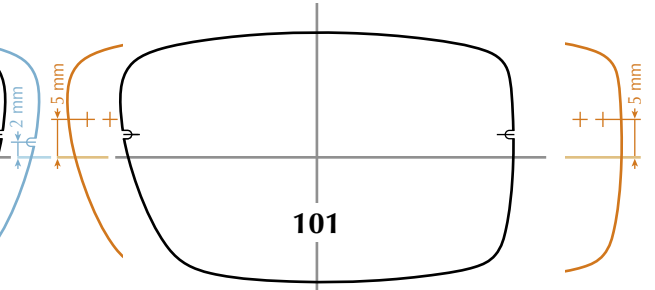
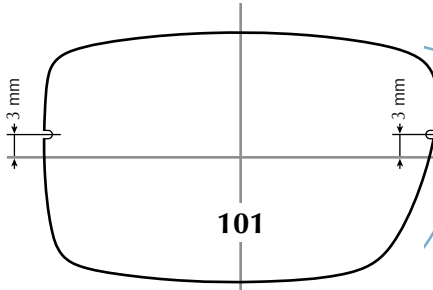
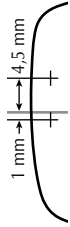
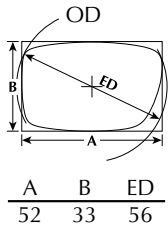

Toutes ces informations sont communiquées à titre indicatif et doivent être adaptées à la forme du nez du porteur.  
All infos provided must be adapted to shape and size of the patient's nose.

⚠ Attention : certaines imprimantes peuvent ne pas reproduire ce document à l'échelle exacte.  
Note: some printers may not duplicate this document at the correct scale.



M-22

Collection "VIS"  
"SCREWS" collection

Pont à vis  
Bridge with screws  
Pont P ou Pont W  
avec selle clipsée  
P bridge or W bridge  
with clipped saddle

Pont W nu  
W bridge bare

Pont à cavaliers  
Plug fit system bridge

Collection "CAVALIERS"  
"WHITOUT SCREWS" collection  
M-10

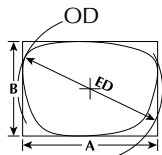

A	B	ED
50	35	54

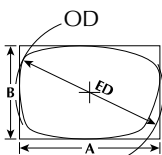

A	B	ED
52	34,5	55

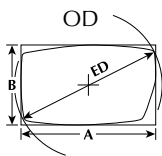

A	B	ED
50	30	55

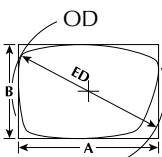

A	B	ED
52	35	57

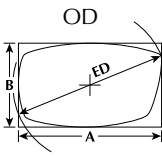

A	B	ED
53	31	57

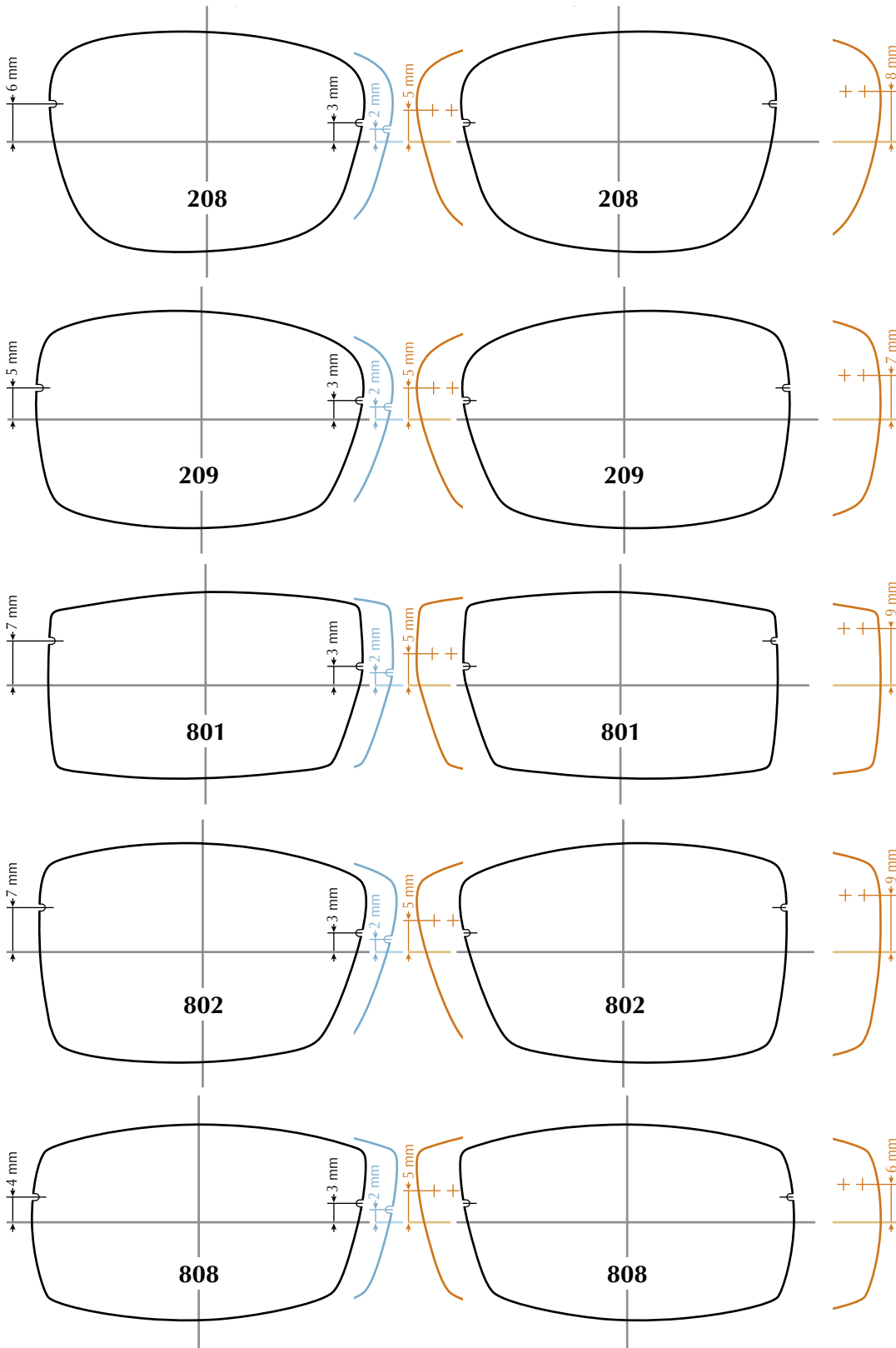
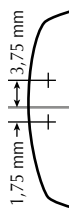
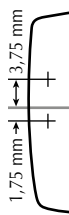
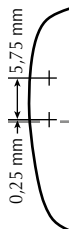

Toutes ces informations sont communiquées à titre indicatif et doivent être adaptées à la forme du nez du porteur.  
All infos provided must be adapted to shape and size of the patient's nose.

⚠ Attention : certaines imprimantes peuvent ne pas reproduire ce document à l'échelle exacte.  
Note: some printers may not duplicate this document at the correct scale.

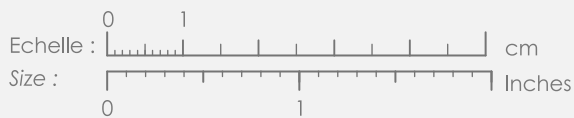

M-22

Collection "VIS"  
"SCREWS" collection

Pont à vis  
Bridge with screws  
Pont P ou Pont W  
avec selle clipsée  
P bridge or W bridge  
with clipped saddle

Pont W nu  
W bridge bare

Pont à cavaliers  
Plug fit system bridge

Collection "CAVALIERS"  
"WHITOUT SCREWS" collection  
M-10

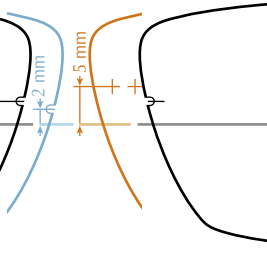
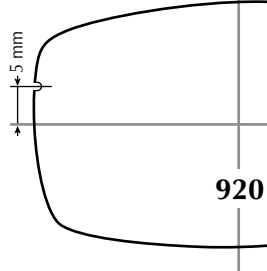
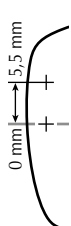
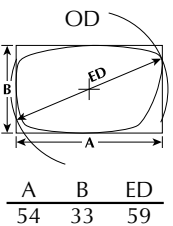
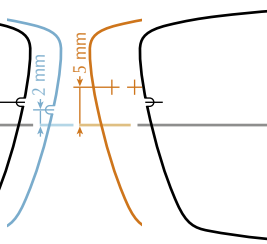
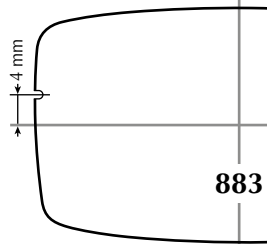
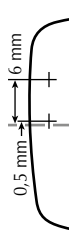
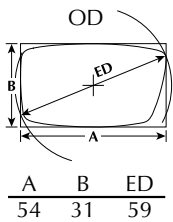
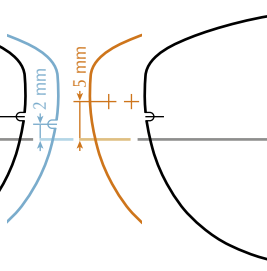
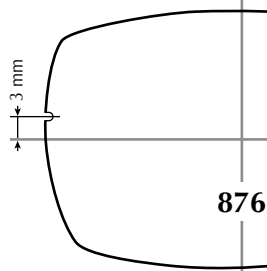
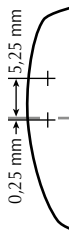
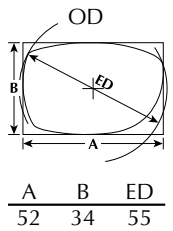
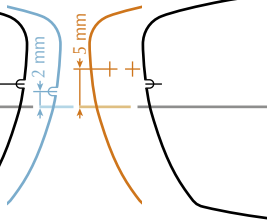
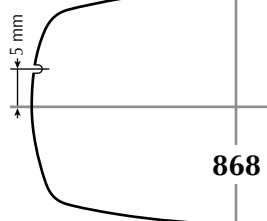
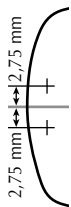
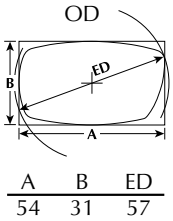
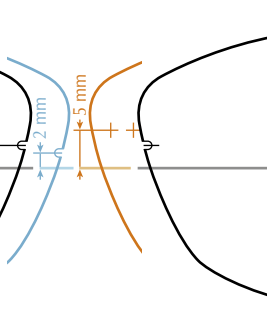
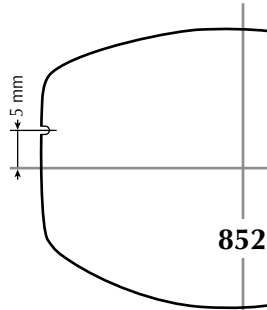
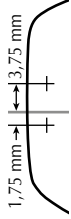
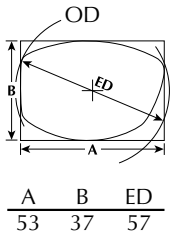

Toutes ces informations sont communiquées à titre indicatif et doivent être adaptées à la forme du nez du porteur.  
All infos provided must be adapted to shape and size of the patient's nose.

⚠ Attention : certaines imprimantes peuvent ne pas reproduire ce document à l'échelle exacte.  
Note: some printers may not duplicate this document at the correct scale.



M-22

Collection "VIS"  
"SCREWS" collection

Pont à vis  
Bridge with screws  
Pont P ou Pont W  
avec selle clipsée  
P bridge or W bridge  
with clipped saddle

Pont W nu  
W bridge bare

Pont à cavaliers  
Plug fit system bridge

Collection "CAVALIERS"  
"WHITOUT SCREWS" collection  
M-10

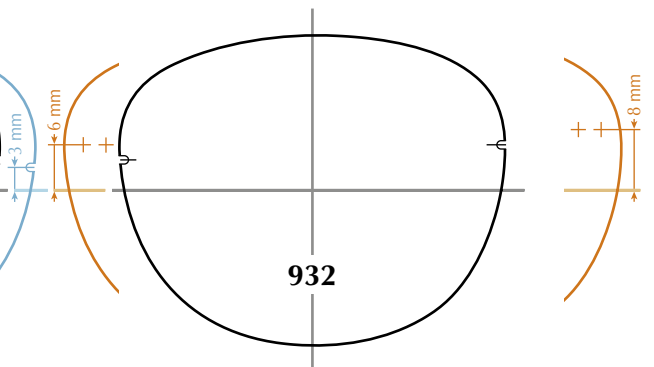
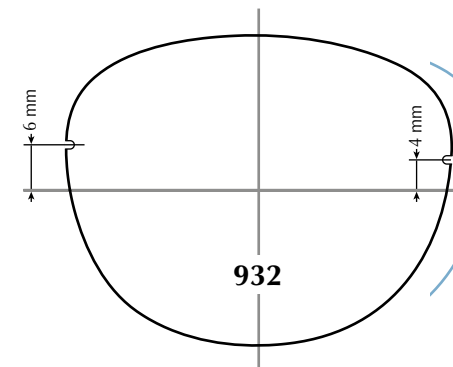
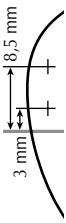
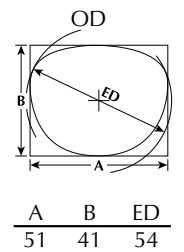
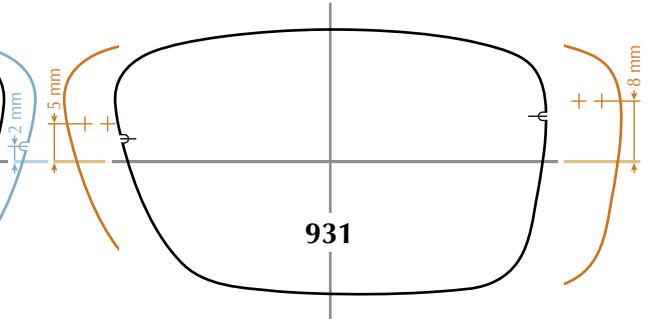
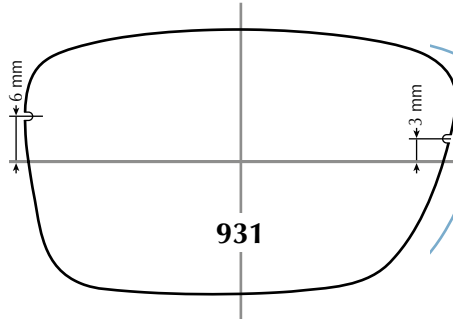
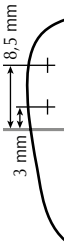
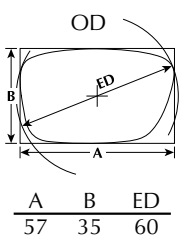
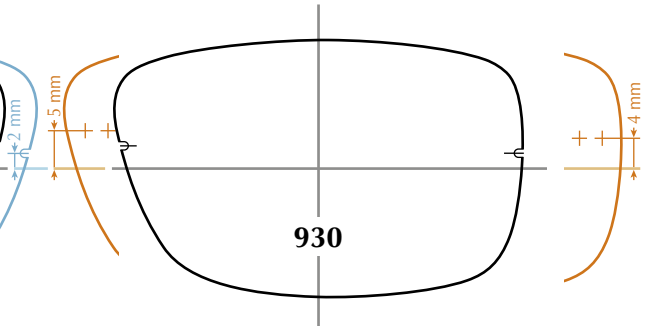
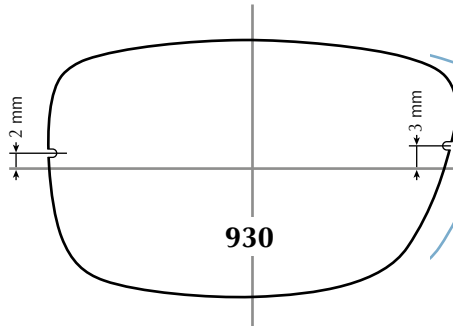
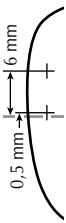
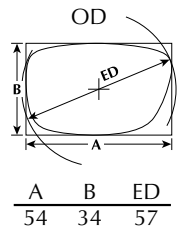
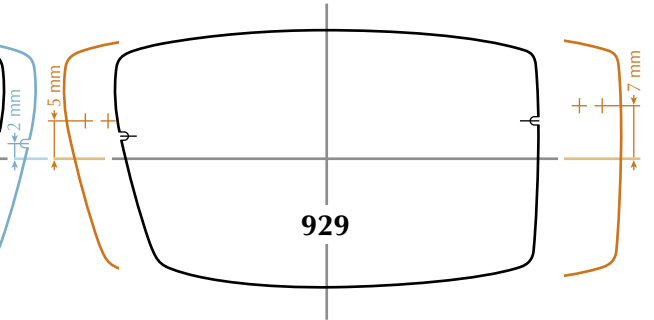
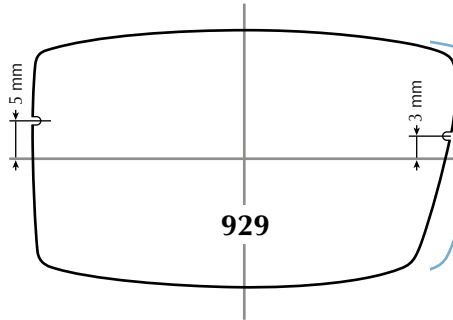
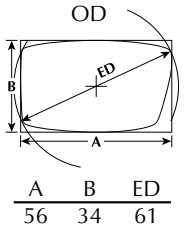

Toutes ces informations sont communiquées à titre indicatif et doivent être adaptées à la forme du nez du porteur.  
All infos provided must be adapted to shape and size of the patient's nose.

⚠ Attention : certaines imprimantes peuvent ne pas reproduire ce document à l'échelle exacte.  
Note: some printers may not duplicate this document at the correct scale.



M-22

Collection "VIS"  
"SCREWS" collection

Pont à vis  
Bridge with screws  
Pont P ou Pont W  
avec selle clipsée  
P bridge or W bridge  
with clipped saddle

Pont W nu  
W bridge bare

Pont à cavaliers  
Plug fit system bridge

Collection "CAVALIERS"  
"WHITOUT SCREWS" collection  
M-10

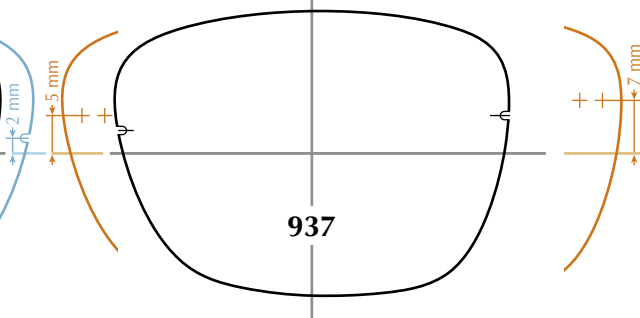
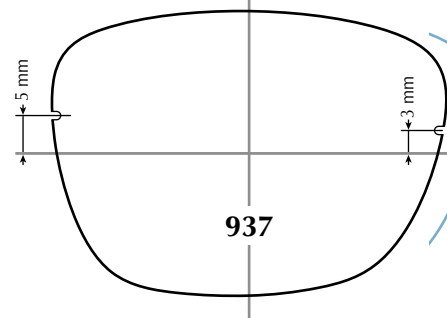
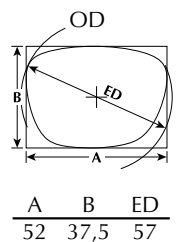
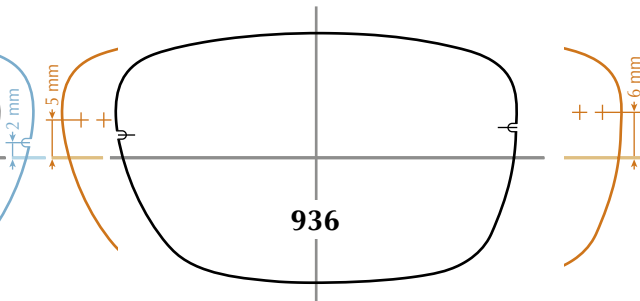
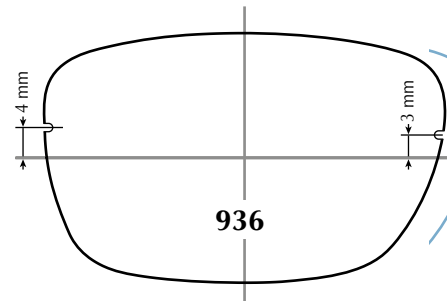
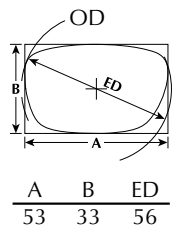
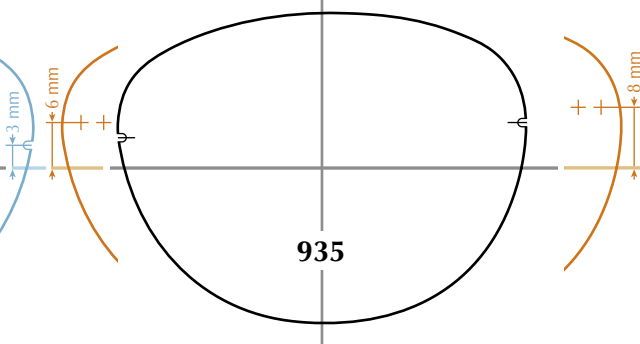
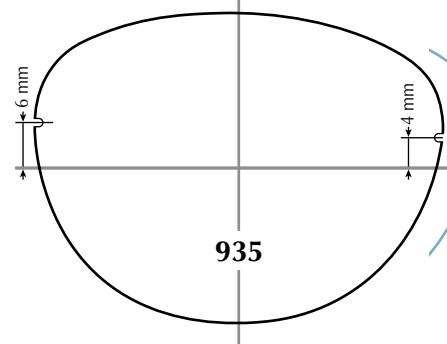
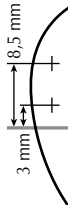
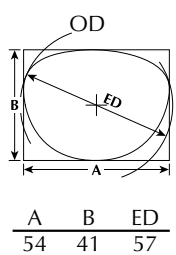
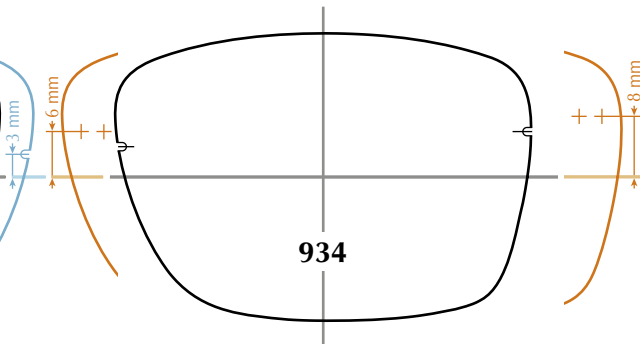
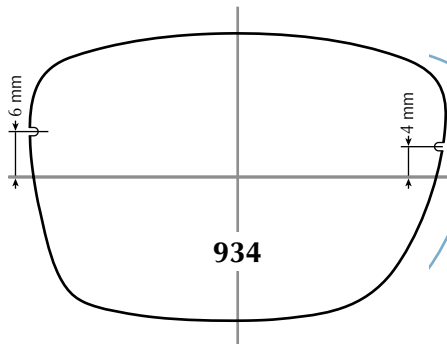
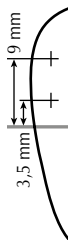
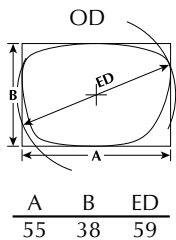

Toutes ces informations sont communiquées à titre indicatif et doivent être adaptées à la forme du nez du porteur.  
All infos provided must be adapted to shape and size of the patient's nose.

⚠ Attention : certaines imprimantes peuvent ne pas reproduire ce document à l'échelle exacte.  
Note: some printers may not duplicate this document at the correct scale.

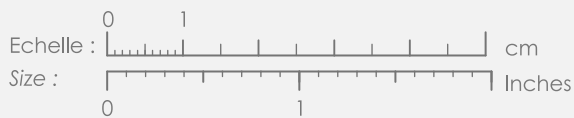

M-22

Collection "VIS"  
"SCREWS" collection

Pont à vis  
Bridge with screws  
Pont P ou Pont W  
avec selle clipsée  
P bridge or W bridge  
with clipped saddle

Pont W nu  
W bridge bare

Pont à cavaliers  
Plug fit system bridge

Collection "CAVALIERS"  
"WHITOUT SCREWS" collection  
M-10

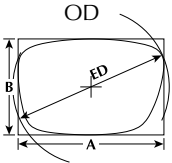

A	B	ED
54	35,5	58

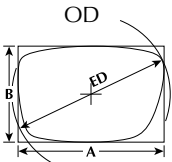

A	B	ED
54	35,5	59

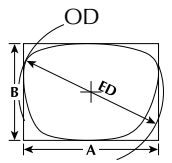

A	B	ED
50	36	54

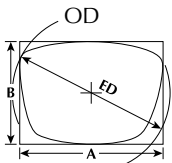

A	B	ED
53	38	59

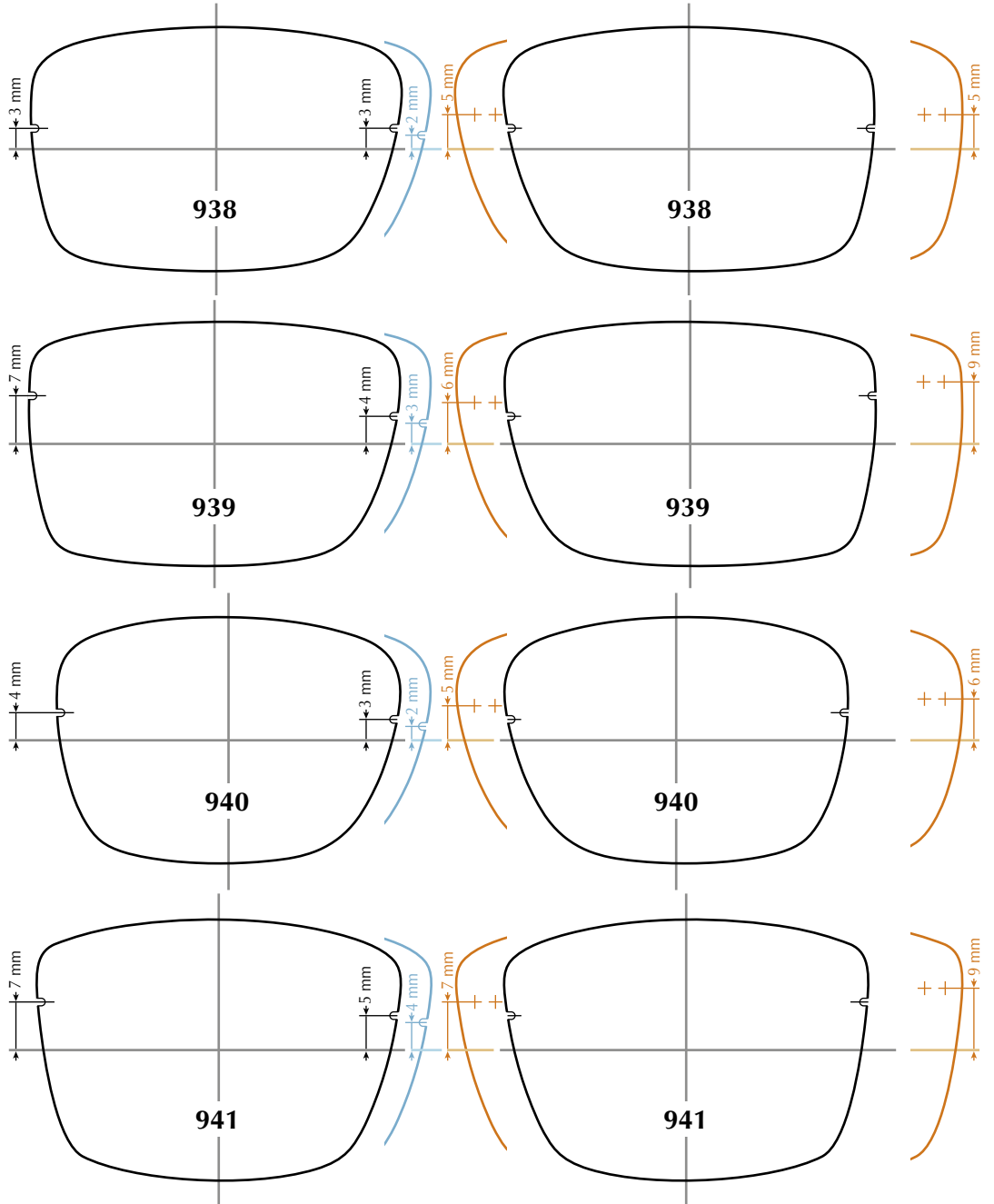

Toutes ces informations sont communiquées à titre indicatif et doivent être adaptées à la forme du nez du porteur.  
All infos provided must be adapted to shape and size of the patient's nose.

⚠ Attention : certaines imprimantes peuvent ne pas reproduire ce document à l'échelle exacte.  
Note: some printers may not duplicate this document at the correct scale.





M-22

Collection "VIS"  
"SCREWS" collection

Pont à vis  
Bridge with screws  
Pont P ou Pont W  
avec selle clipsée  
P bridge or W bridge  
with clipped saddle

Pont W nu  
W bridge bare

Pont à cavaliers  
Plug fit system bridge

Collection "CAVALIERS"  
"WHITOUT SCREWS" collection  
M-10

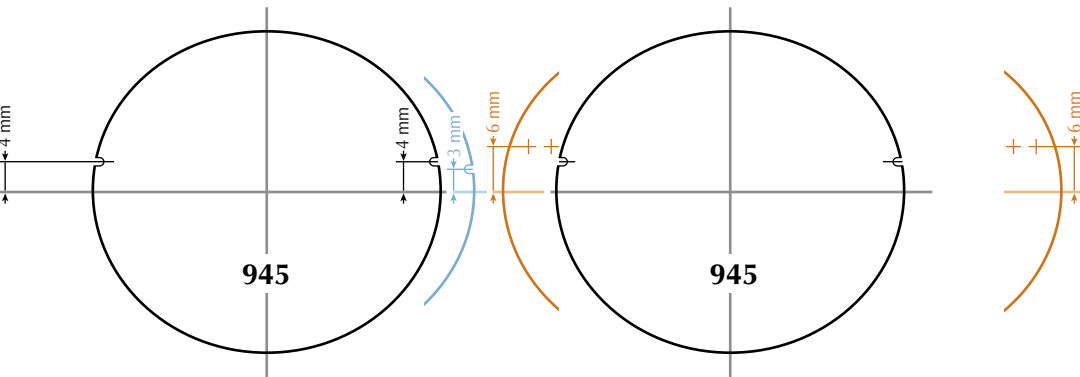
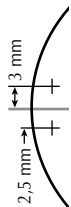
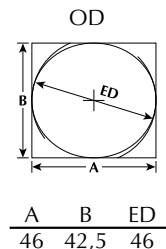
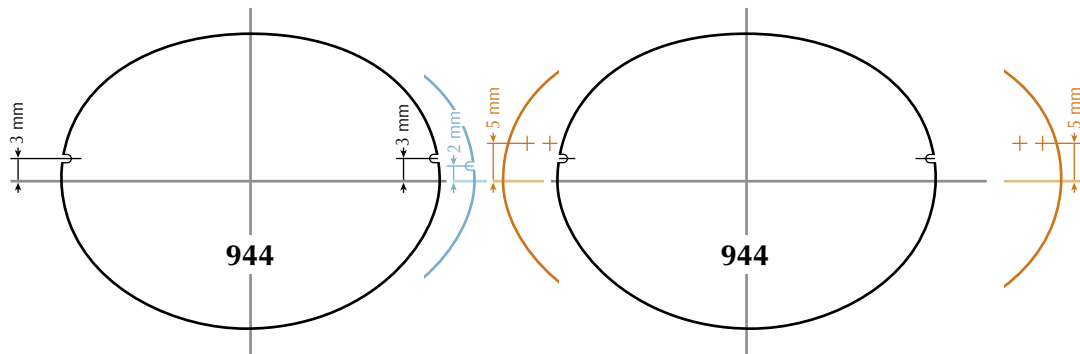
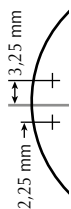
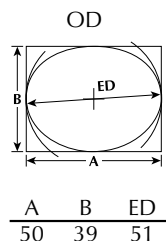
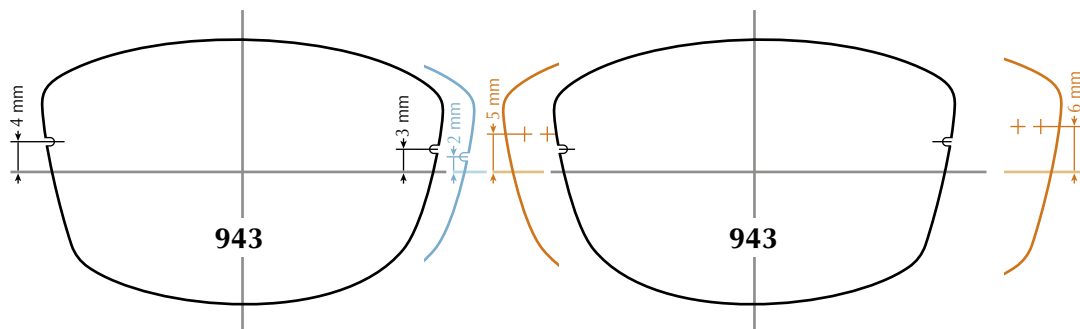
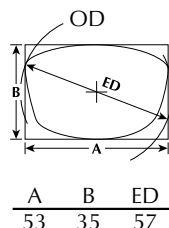
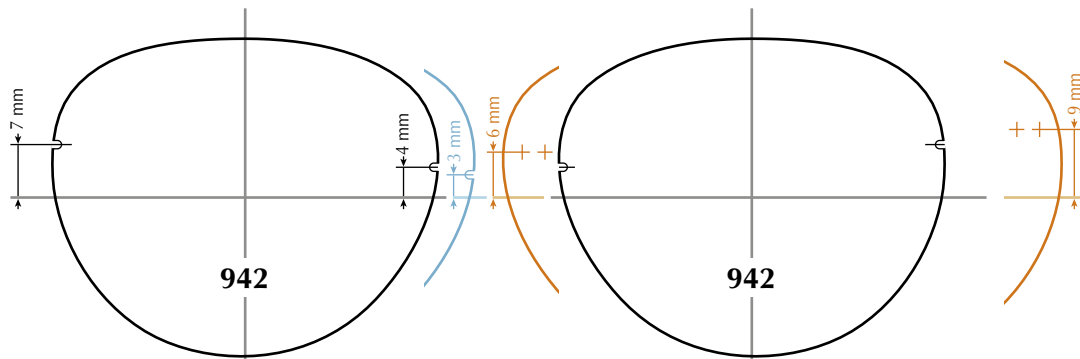
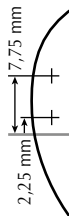
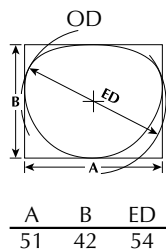

Toutes ces informations sont communiquées à titre indicatif et doivent être adaptées à la forme du nez du porteur.  
All infos provided must be adapted to shape and size of the patient's nose.

⚠ Attention : certaines imprimantes peuvent ne pas reproduire ce document à l'échelle exacte.  
Note: some printers may not duplicate this document at the correct scale.

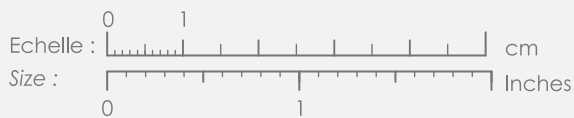

M-22

Collection "VIS"  
"SCREWS" collection

Pont à vis  
Bridge with screws  
Pont P ou Pont W  
avec selle clipsée  
P bridge or W bridge  
with clipped saddle

Pont W nu  
W bridge bare

Pont à cavaliers  
Plug fit system bridge

Collection "CAVALIERS"  
"WHITOUT SCREWS" collection  
M-10

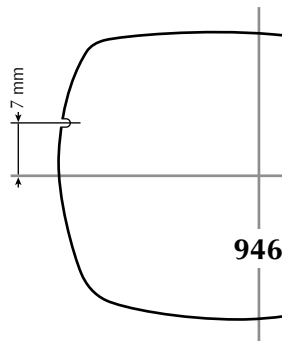
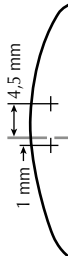
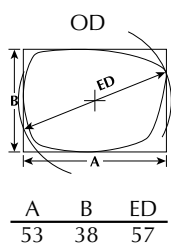

946

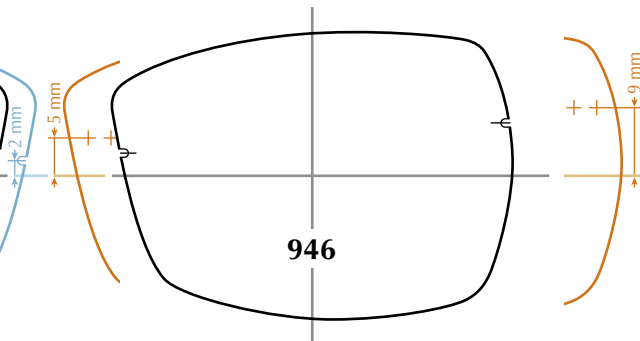

946

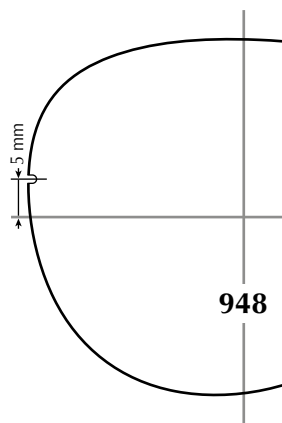
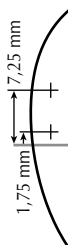
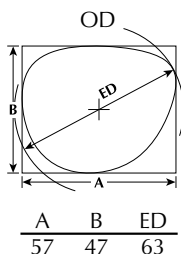

948

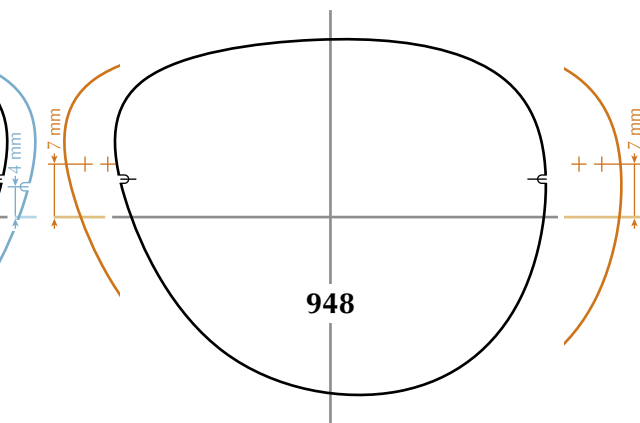

948

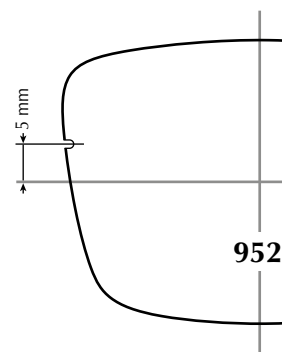
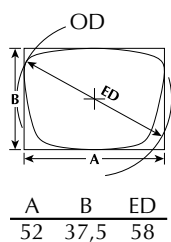

952

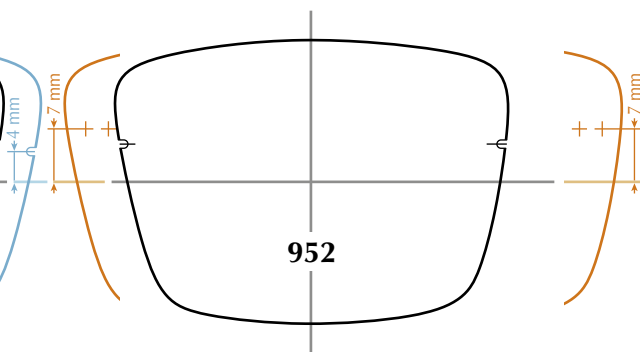

952

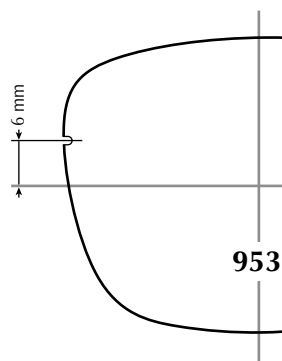
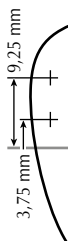
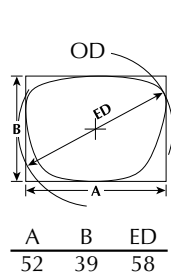

953

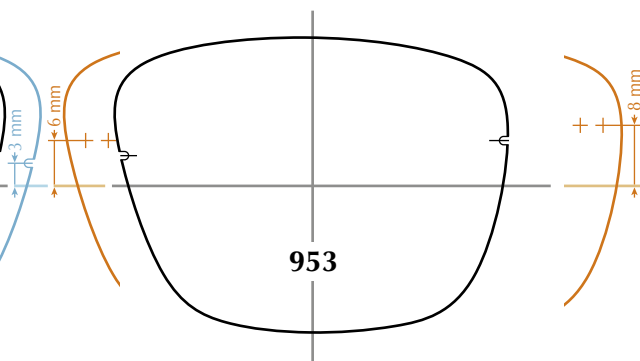

953

Toutes ces informations sont communiquées à titre indicatif et doivent être adaptées à la forme du nez du porteur.  
All infos provided must be adapted to shape and size of the patient's nose.

⚠ Attention : certaines imprimantes peuvent ne pas reproduire ce document à l'échelle exacte.  
Note: some printers may not duplicate this document at the correct scale.



M-22

Collection "VIS" "SCREWS" collection

Pont à vis  
Bridge with screws  
Pont P ou Pont W  
avec selle clipsée  
P bridge or W bridge  
with clipped saddle

Pont W nu  
W bridge bare

Pont à cavaliers  
Plug fit system bridge

Collection "CAVALIERS"  
"WHITOUT SCREWS" collection  
M-10

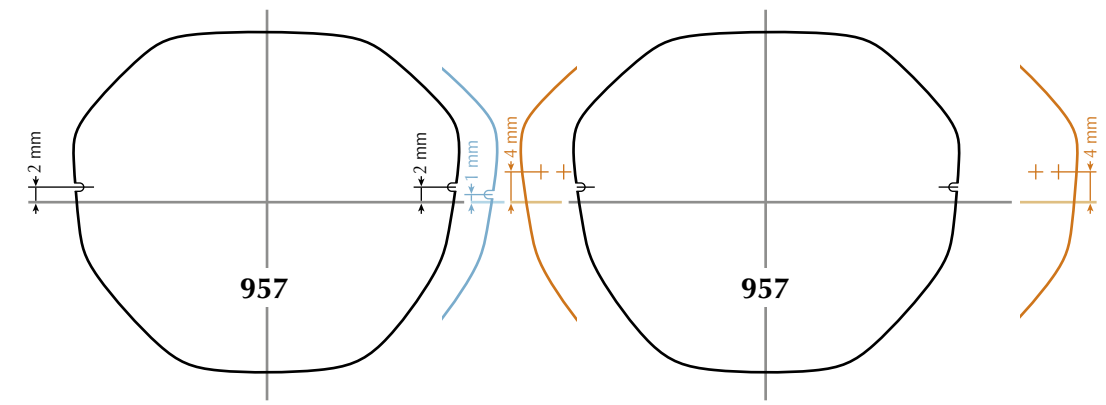
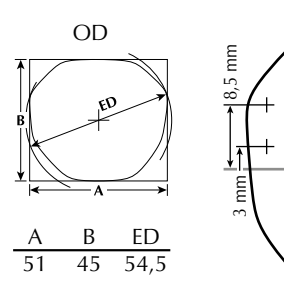
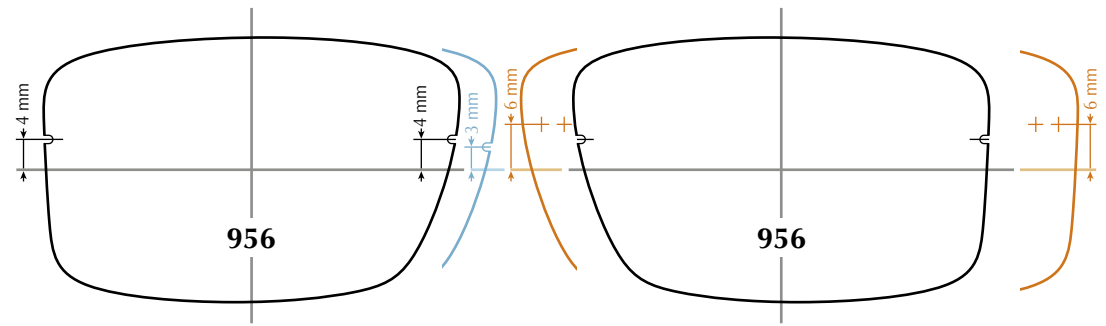
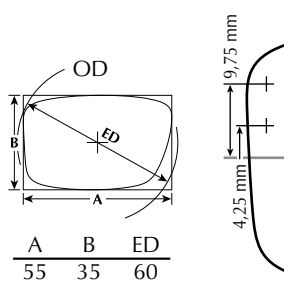
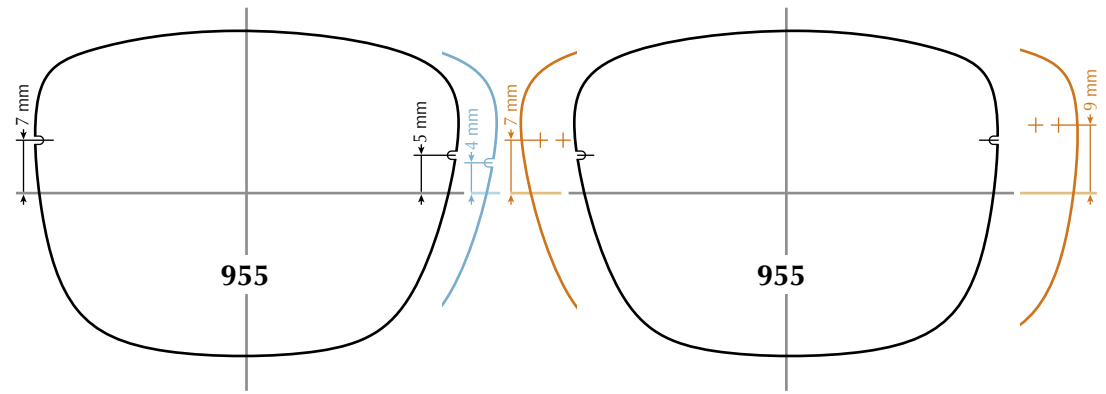
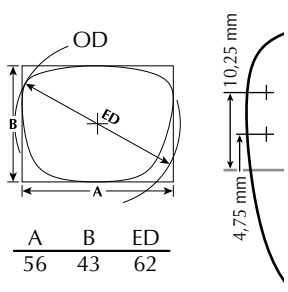
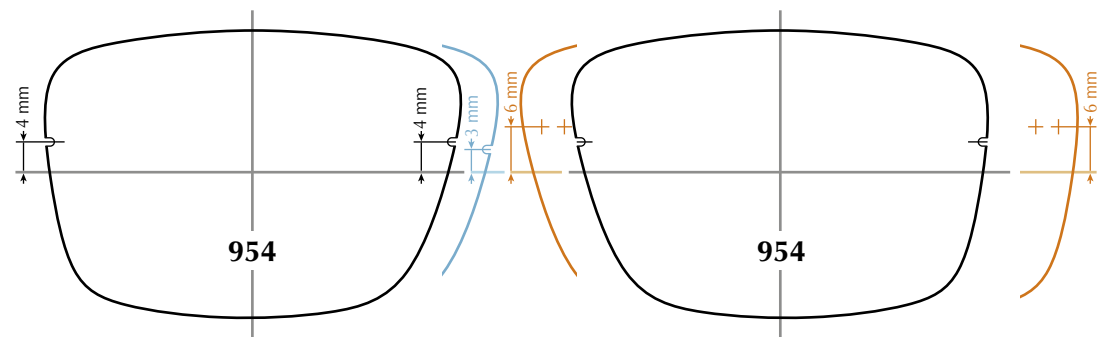
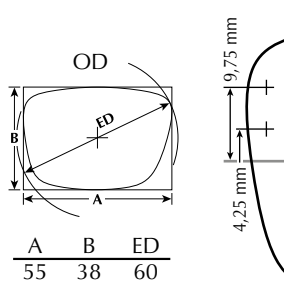

Toutes ces informations sont communiquées à titre indicatif et doivent être adaptées à la forme du nez du porteur.  
All infos provided must be adapted to shape and size of the patient's nose.

⚠ Attention : certaines imprimantes peuvent ne pas reproduire ce document à l'échelle exacte.  
Note: some printers may not duplicate this document at the correct scale.



M-22

Collection "VIS" "SCREWS" collection

Pont à vis  
Bridge with screws  
Pont P ou Pont W  
avec selle clipsée  
P bridge or W bridge  
with clipped saddle

Pont W nu  
W bridge bare

Pont à cavaliers  
Plug fit system bridge

Collection "CAVALIERS"  
"WHITOUT SCREWS" collection  
M-10

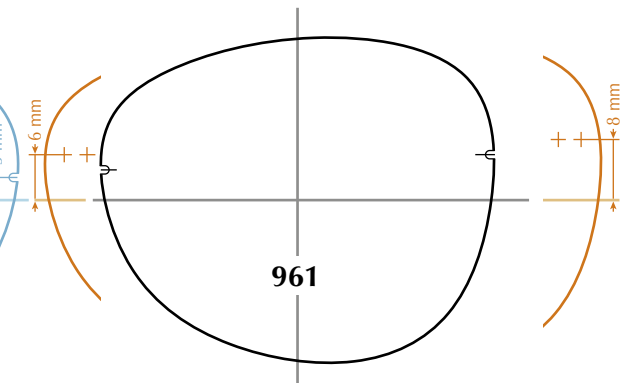
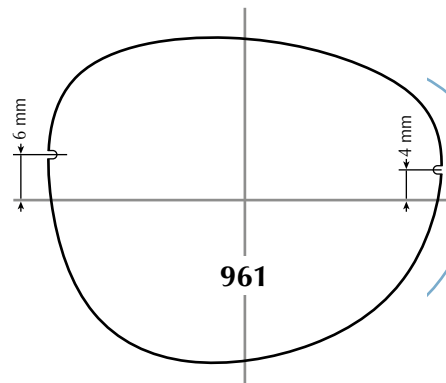
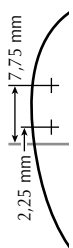
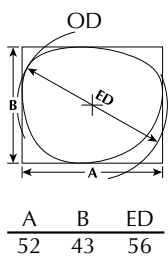
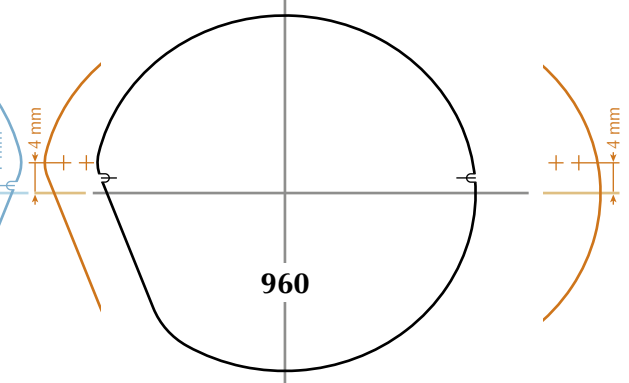
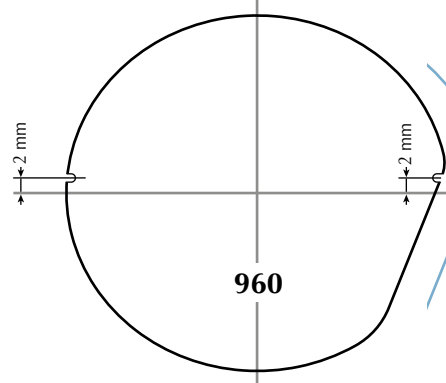
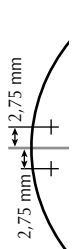
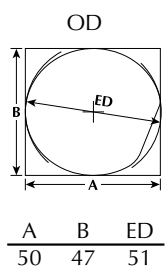
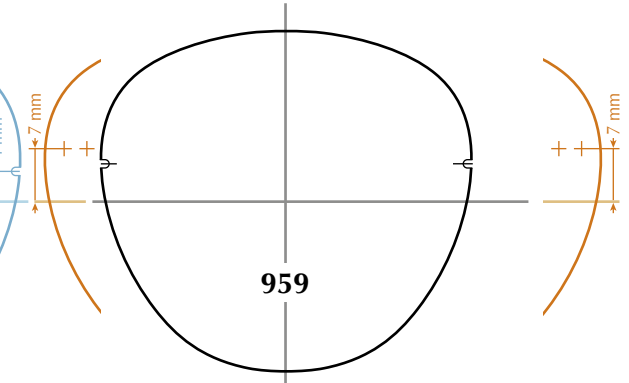
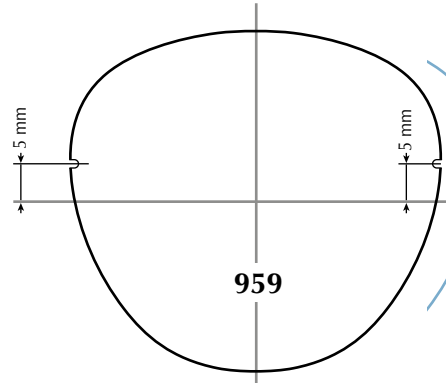
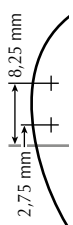
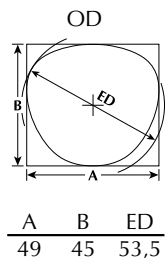
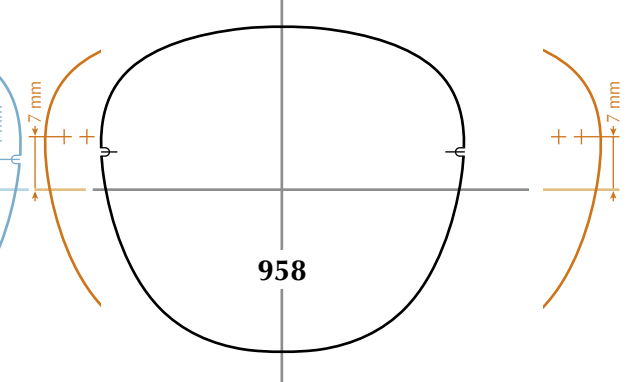
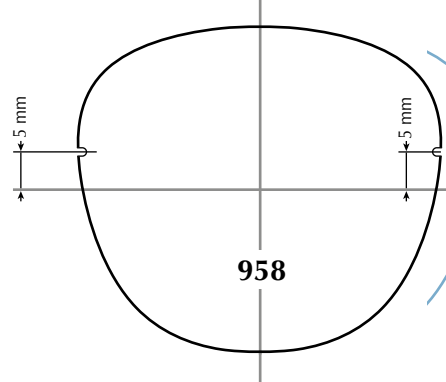
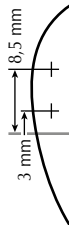
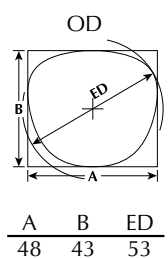

Toutes ces informations sont communiquées à titre indicatif et doivent être adaptées à la forme du nez du porteur.  
All infos provided must be adapted to shape and size of the patient's nose.

Attention : certaines imprimantes peuvent ne pas reproduire ce document à l'échelle exacte.  
Note: some printers may not duplicate this document at the correct scale.



M-22

Collection "VIS"  
"SCREWS" collection

Pont à vis  
Bridge with screws  
Pont P ou Pont W  
avec selle clipsée  
P bridge or W bridge  
with clipped saddle

Pont W nu  
W bridge bare

Pont à cavaliers  
Plug fit system bridge

Collection "CAVALIERS"  
"WHITOUT SCREWS" collection  
M-10

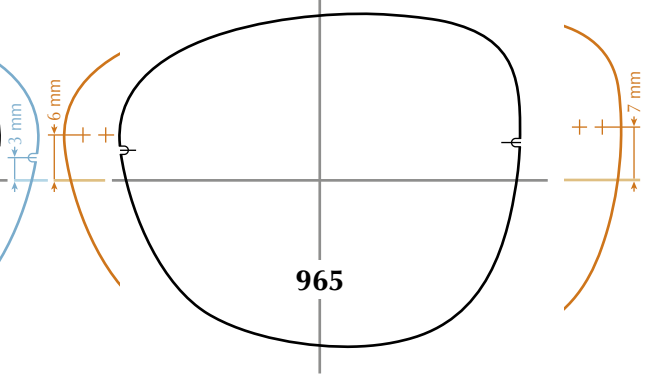
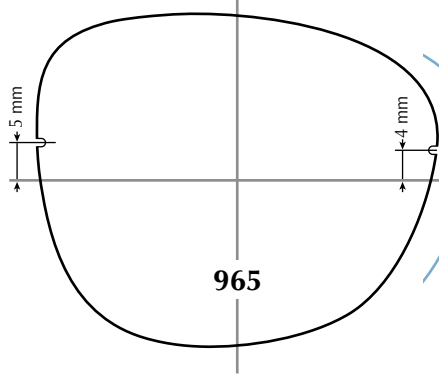
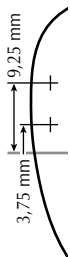
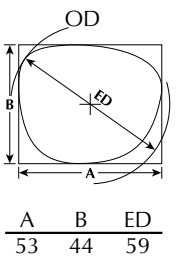
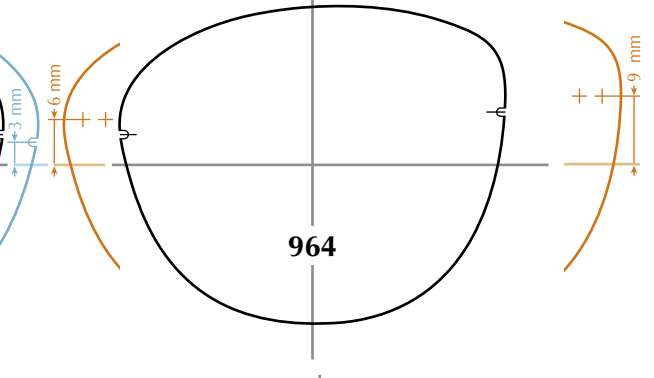
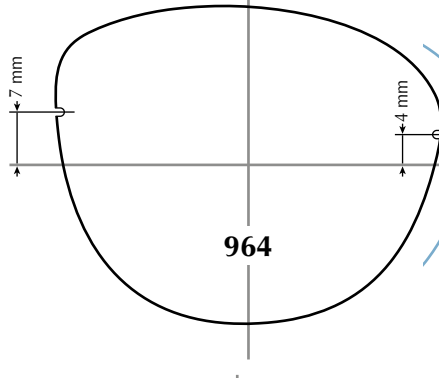
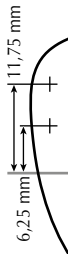
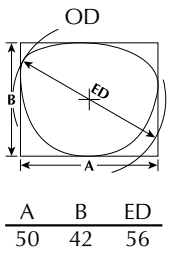
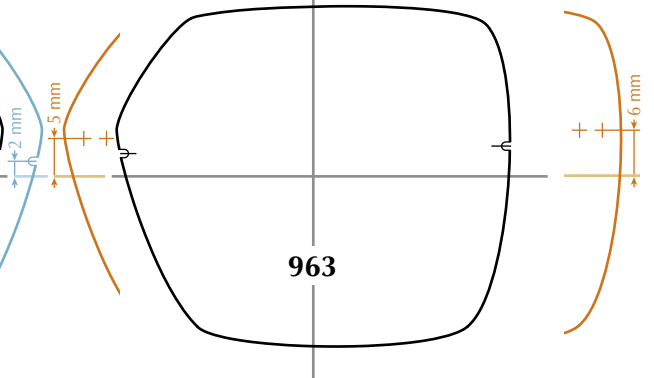
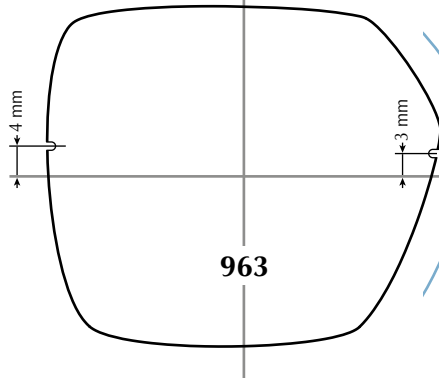
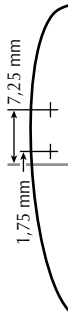
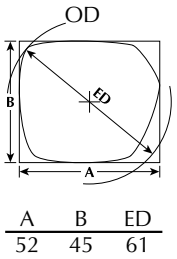
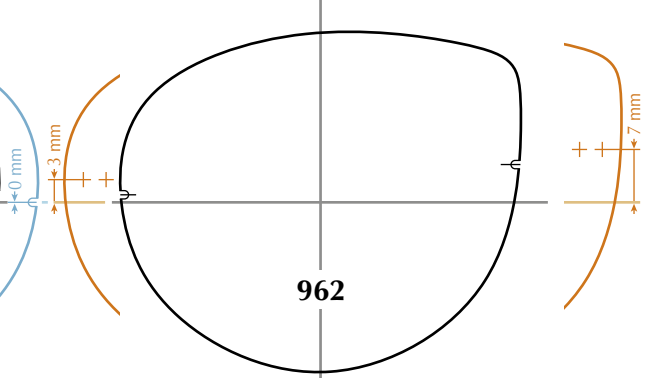
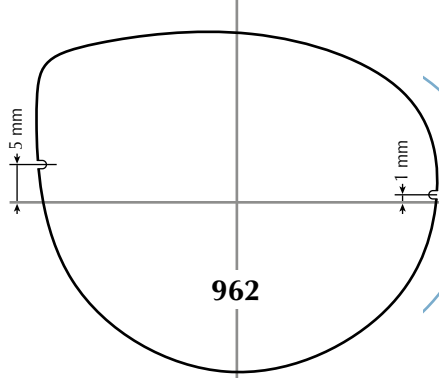
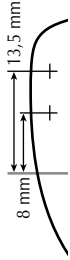
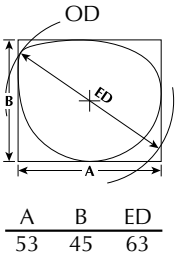

Toutes ces informations sont communiquées à titre indicatif et doivent être adaptées à la forme du nez du porteur.  
All infos provided must be adapted to shape and size of the patient's nose.

⚠ Attention : certaines imprimantes peuvent ne pas reproduire ce document à l'échelle exacte.  
Note: some printers may not duplicate this document at the correct scale.

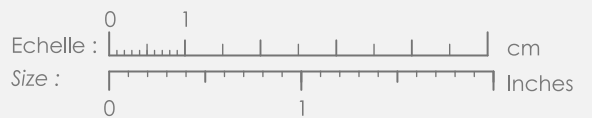

M-22

Collection "VIS"  
"SCREWS" collection

Pont à vis  
Bridge with screws  
Pont P ou Pont W  
avec selle clipsée  
P bridge or W bridge  
with clipped saddle

Pont W nu  
W bridge bare

Pont à cavaliers  
Plug fit system bridge

Collection "CAVALIERS"  
"WHITOUT SCREWS" collection  
M-10

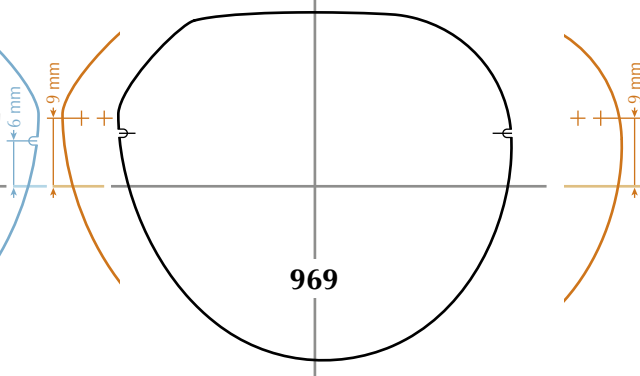
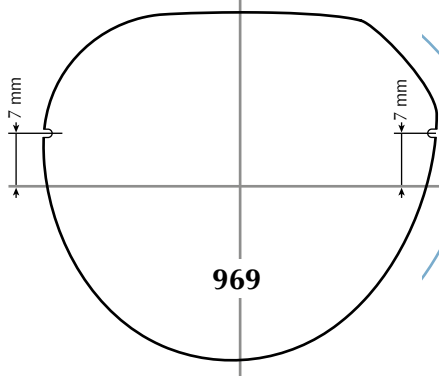
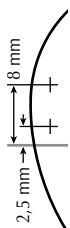
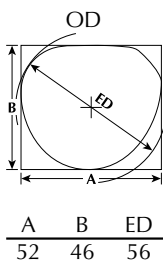
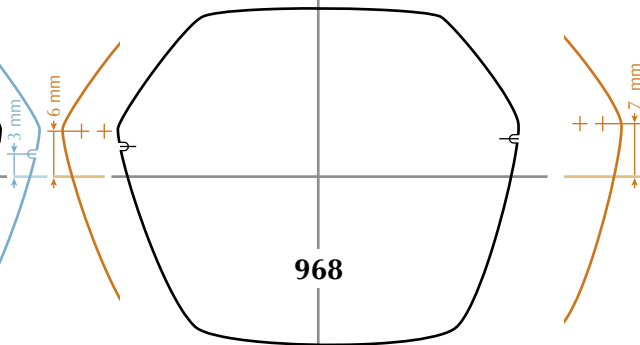
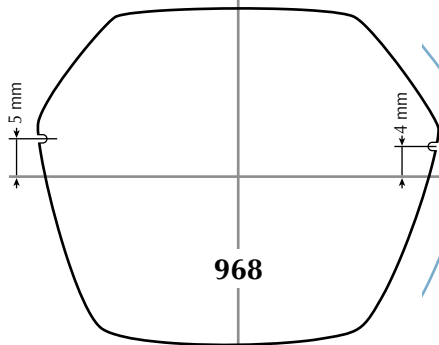
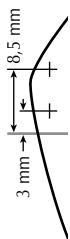
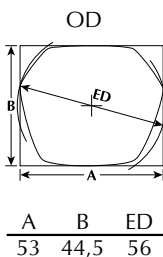
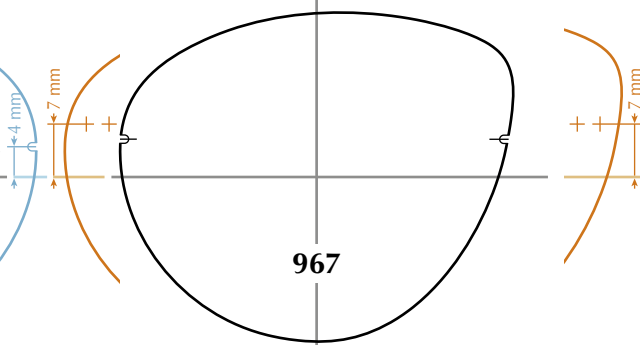
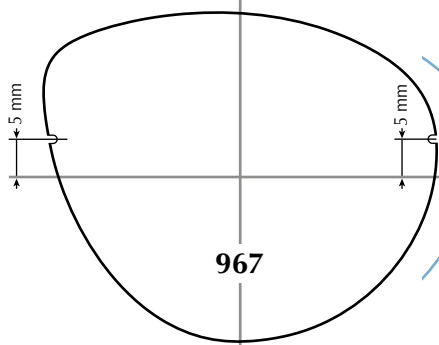
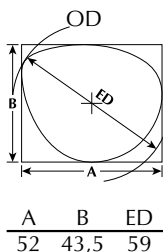
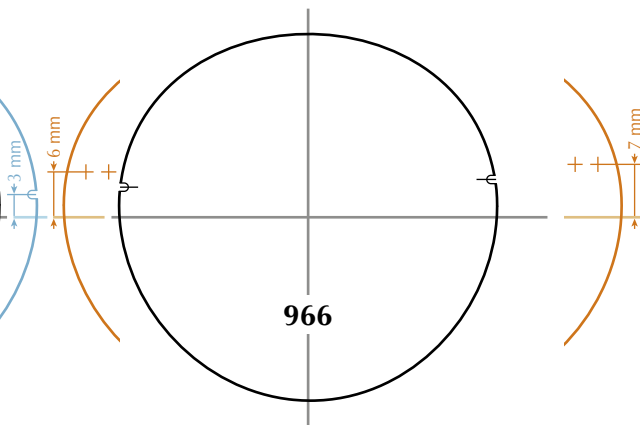
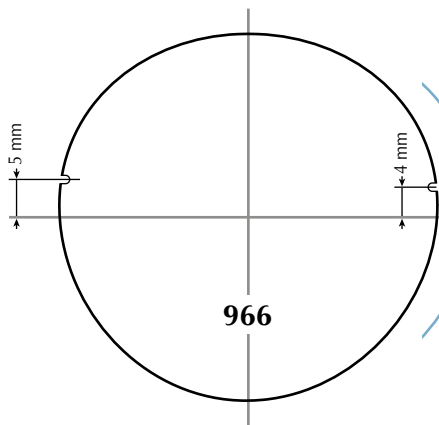
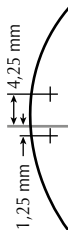
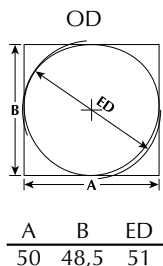

Toutes ces informations sont communiquées à titre indicatif et doivent être adaptées à la forme du nez du porteur.  
All infos provided must be adapted to shape and size of the patient's nose.

⚠ Attention : certaines imprimantes peuvent ne pas reproduire ce document à l'échelle exacte.  
Note: some printers may not duplicate this document at the correct scale.

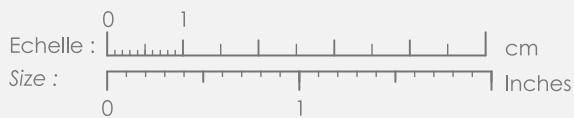

M-22

Collection "VIS"  
"SCREWS" collection

Pont à vis  
Bridge with screws  
Pont P ou Pont W  
avec selle clipsée  
P bridge or W bridge  
with clipped saddle

Pont W nu  
W bridge bare

Pont à cavaliers  
Plug fit system bridge

Collection "CAVALIERS"  
"WHITOUT SCREWS" collection  
M-10

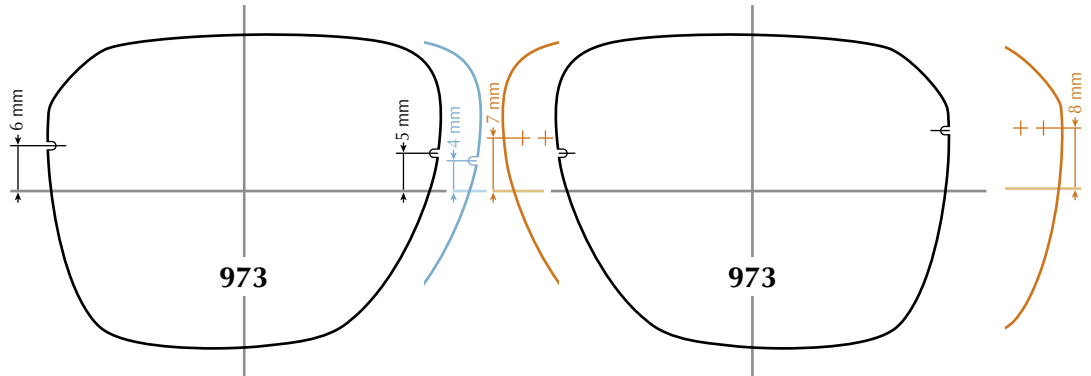
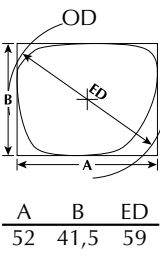
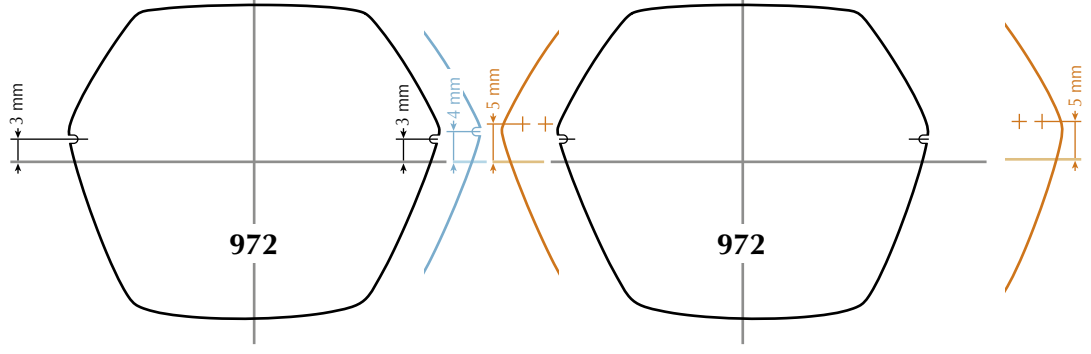
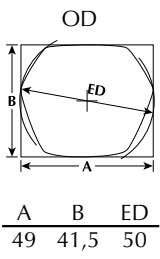
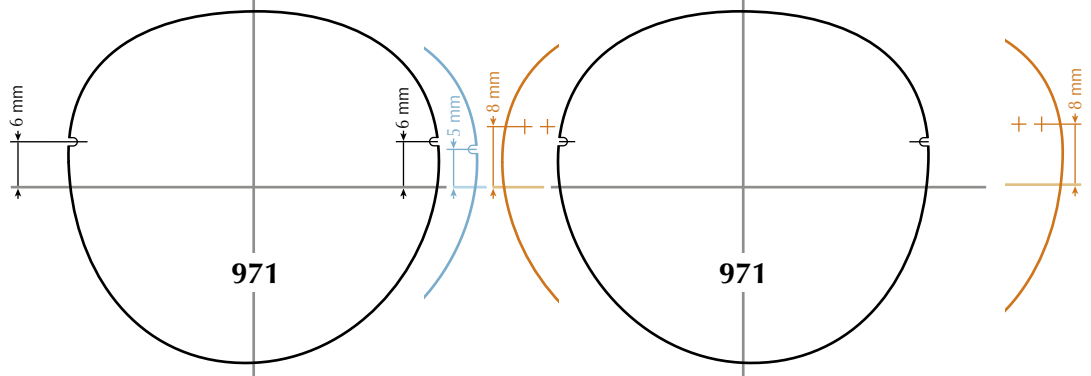
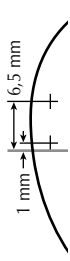
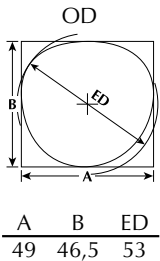
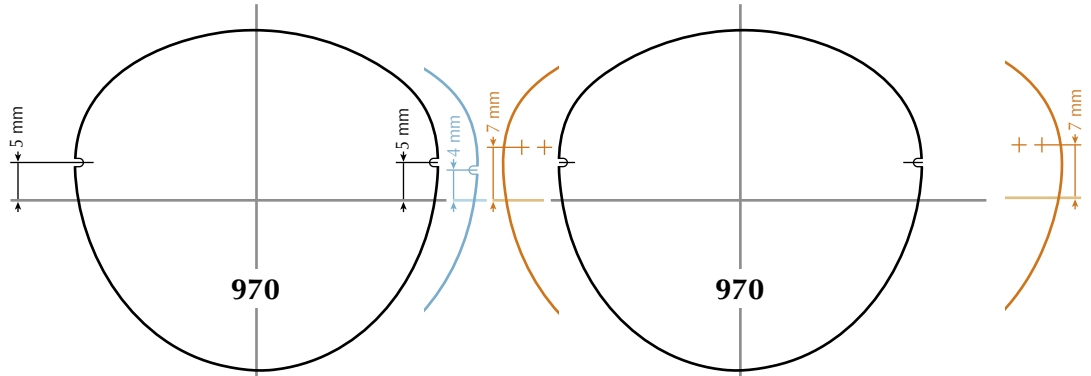
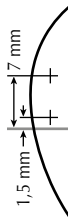
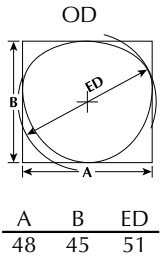

Toutes ces informations sont communiquées à titre indicatif et doivent être adaptées à la forme du nez du porteur.  
All infos provided must be adapted to shape and size of the patient's nose.

⚠ Attention : certaines imprimantes peuvent ne pas reproduire ce document à l'échelle exacte.  
Note: some printers may not duplicate this document at the correct scale.



M-22

Collection "VIS"  
"SCREWS" collection

Pont à vis  
Bridge with screws  
Pont P ou Pont W  
avec selle clipsée  
P bridge or W bridge  
with clipped saddle

Pont W nu  
W bridge bare

Pont à cavaliers  
Plug fit system bridge

Collection "CAVALIERS"  
"WHITOUT SCREWS" collection  
M-10

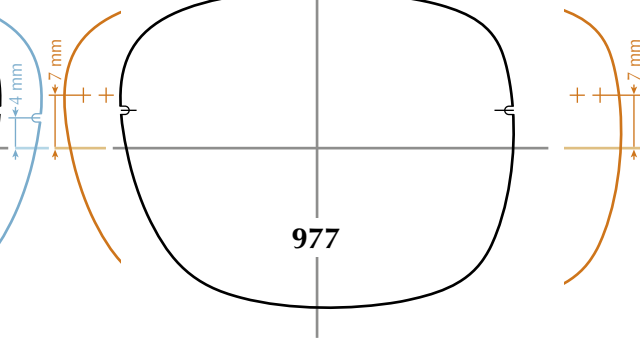
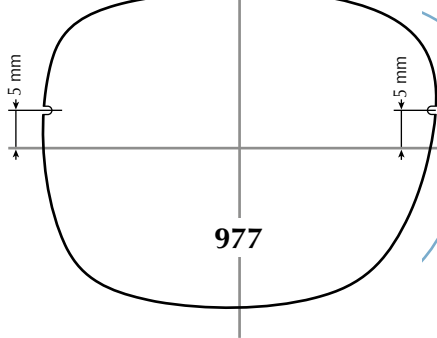
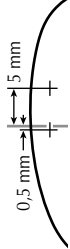
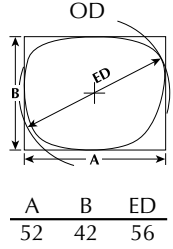
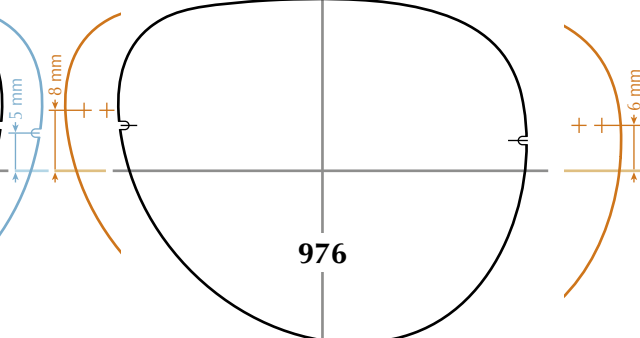
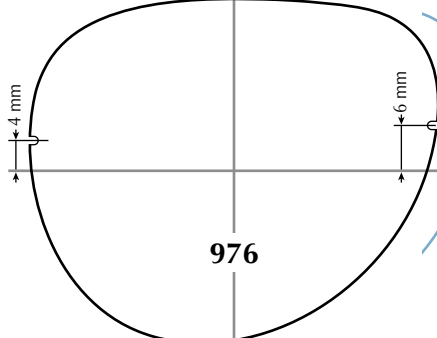
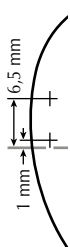
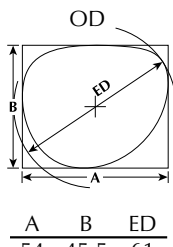
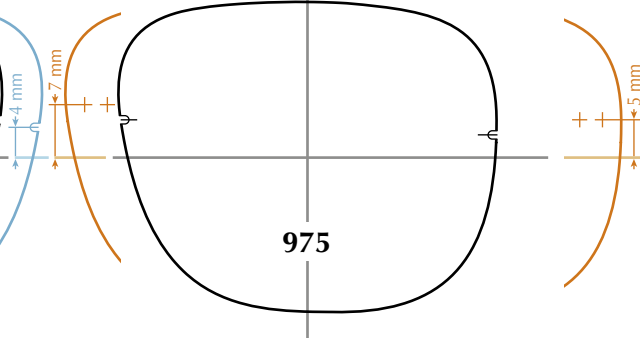
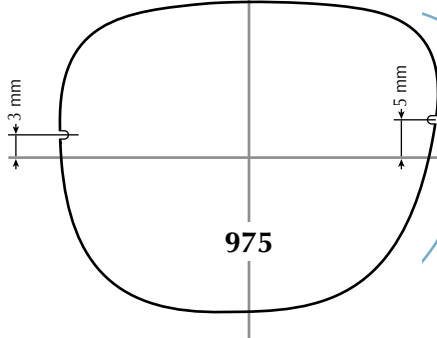
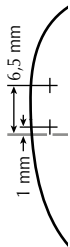
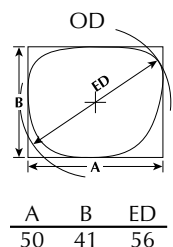
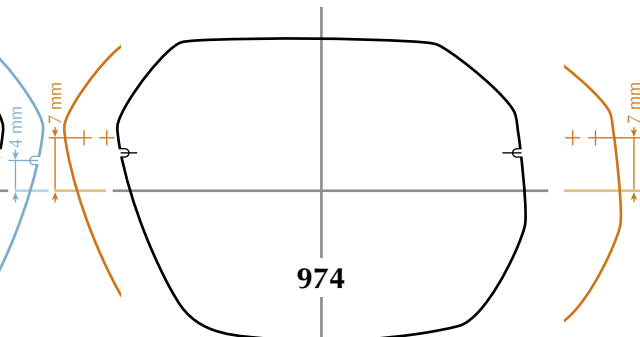
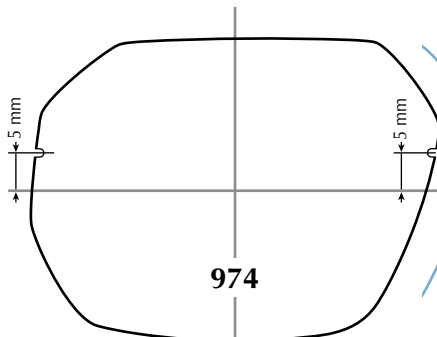
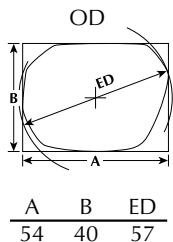

Toutes ces informations sont communiquées à titre indicatif et doivent être adaptées à la forme du nez du porteur.  
All infos provided must be adapted to shape and size of the patient's nose.

⚠ Attention : certaines imprimantes peuvent ne pas reproduire ce document à l'échelle exacte.  
Note: some printers may not duplicate this document at the correct scale.

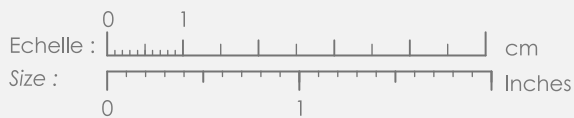



M-22

Collection "VIS"  
"SCREWS" collection

Pont à vis  
Bridge with screws  
Pont P ou Pont W  
avec selle clipsée  
P bridge or W bridge  
with clipped saddle

Pont W nu  
W bridge bare

Pont à cavaliers  
Plug fit system bridge

Collection "CAVALIERS"  
"WHITOUT SCREWS" collection  
M-10

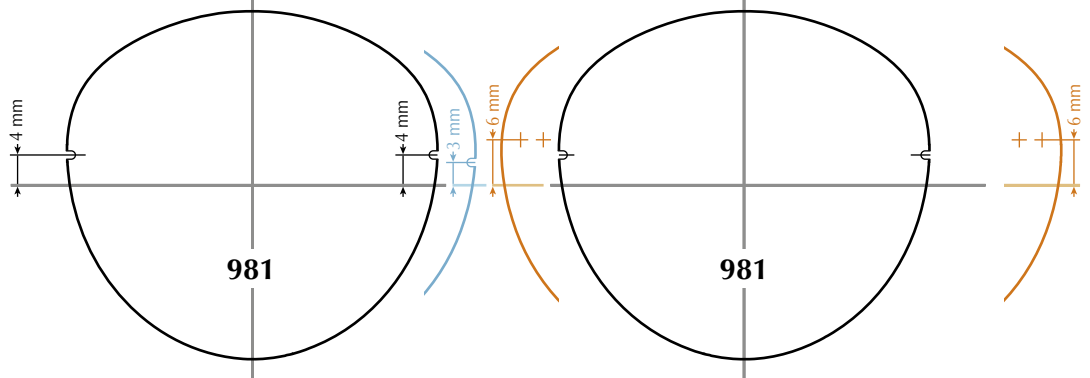
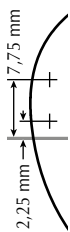
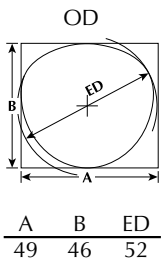
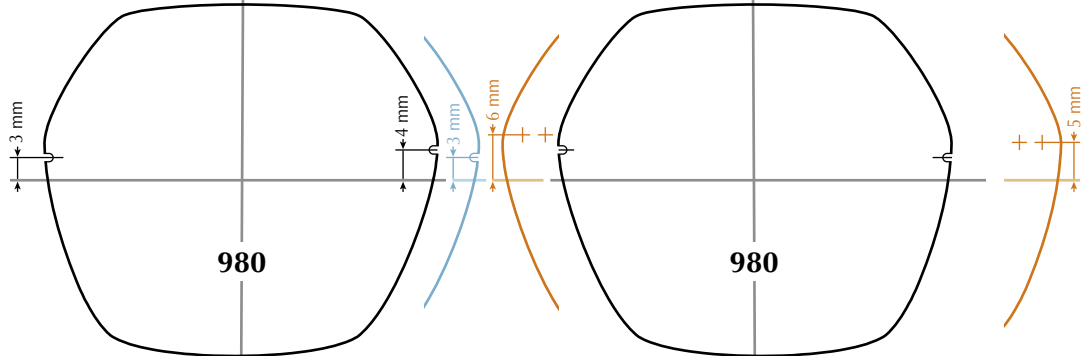
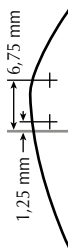
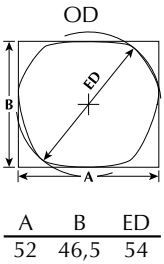
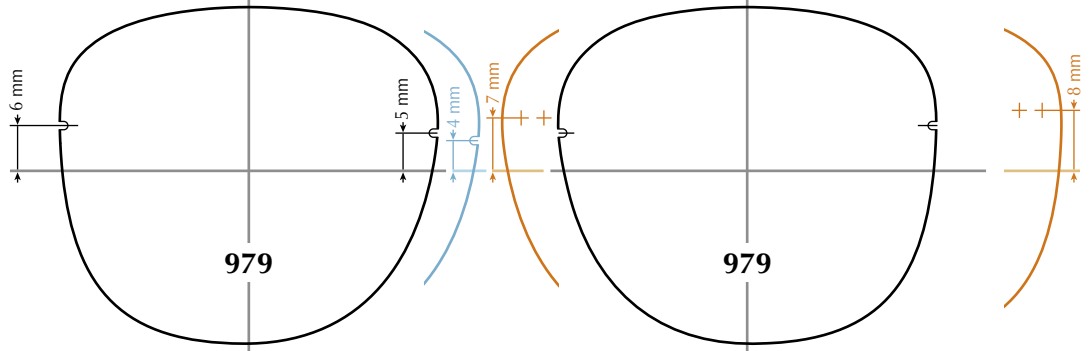
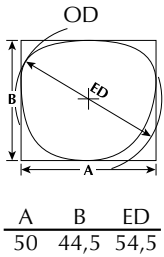
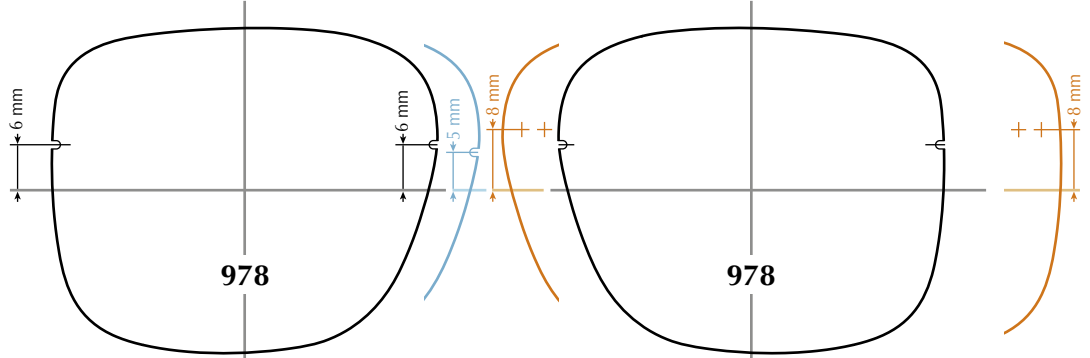
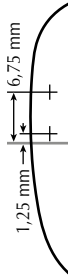
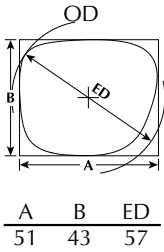

Toutes ces informations sont communiquées à titre indicatif et doivent être adaptées à la forme du nez du porteur.  
All infos provided must be adapted to shape and size of the patient's nose.

▲ Attention : certaines imprimantes peuvent ne pas reproduire ce document à l'échelle exacte.  
Note: some printers may not duplicate this document at the correct scale.



M-22

Collection "VIS" "SCREWS" collection

Pont à vis  
Bridge with screws  
Pont P ou Pont W  
avec selle clipsée  
P bridge or W bridge  
with clipped saddle

Pont W nu  
W bridge bare

Pont à cavaliers  
Plug fit system bridge

Collection "CAVALIERS"  
"WHITOUT SCREWS" collection  
M-10

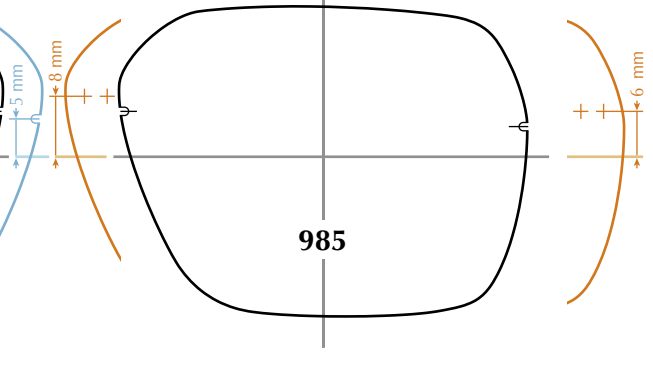
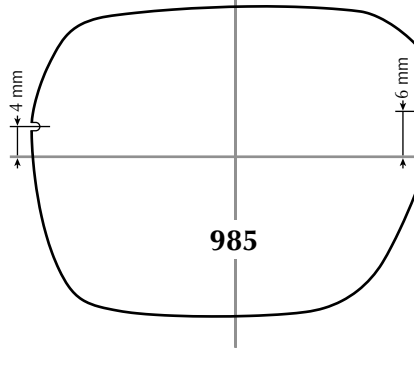
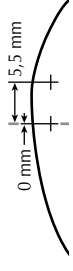
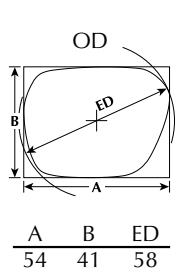
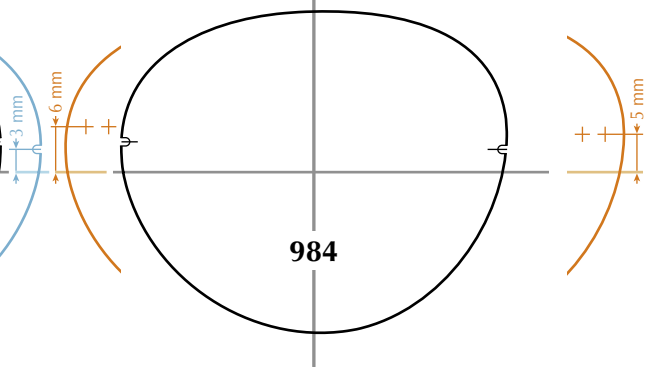
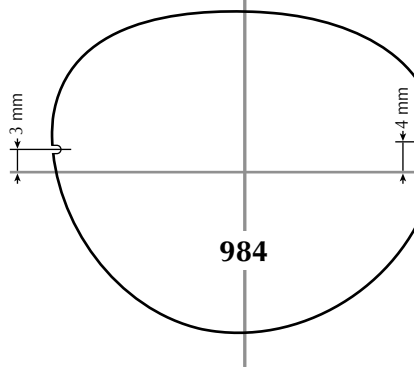
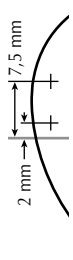
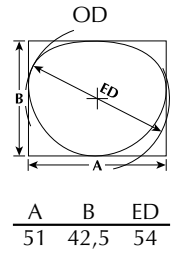
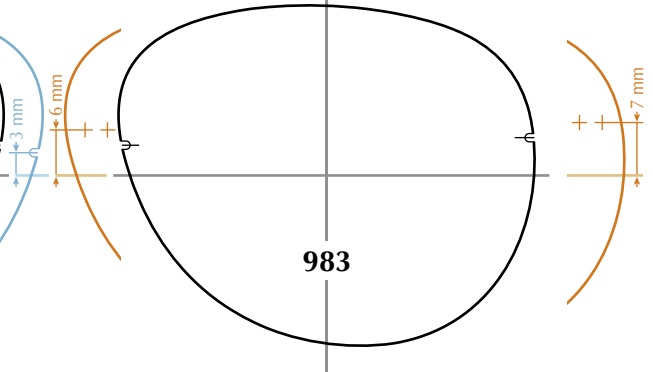
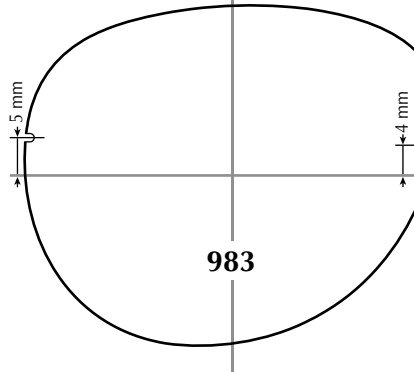
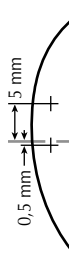
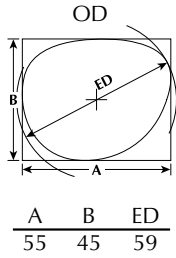
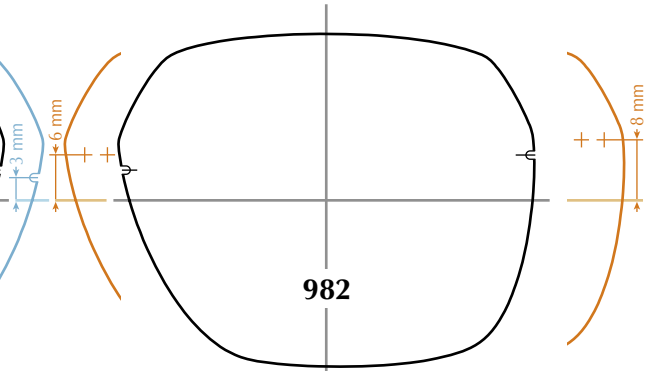
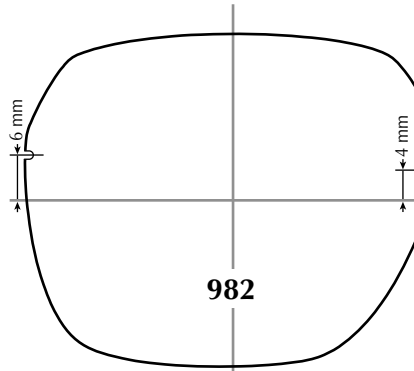
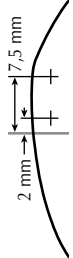
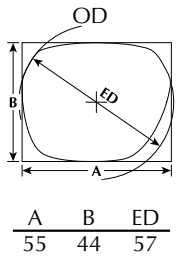

Toutes ces informations sont communiquées à titre indicatif et doivent être adaptées à la forme du nez du porteur.  
All infos provided must be adapted to shape and size of the patient's nose.

⚠ Attention : certaines imprimantes peuvent ne pas reproduire ce document à l'échelle exacte.  
Note: some printers may not duplicate this document at the correct scale.



M-22

Collection "VIS"  
"SCREWS" collection

Pont à vis  
Bridge with screws  
Pont P ou Pont W  
avec selle clipsée  
P bridge or W bridge  
with clipped saddle

Pont W nu  
W bridge bare

Pont à cavaliers  
Plug fit system bridge

Collection "CAVALIERS"  
"WHITOUT SCREWS" collection  
M-10

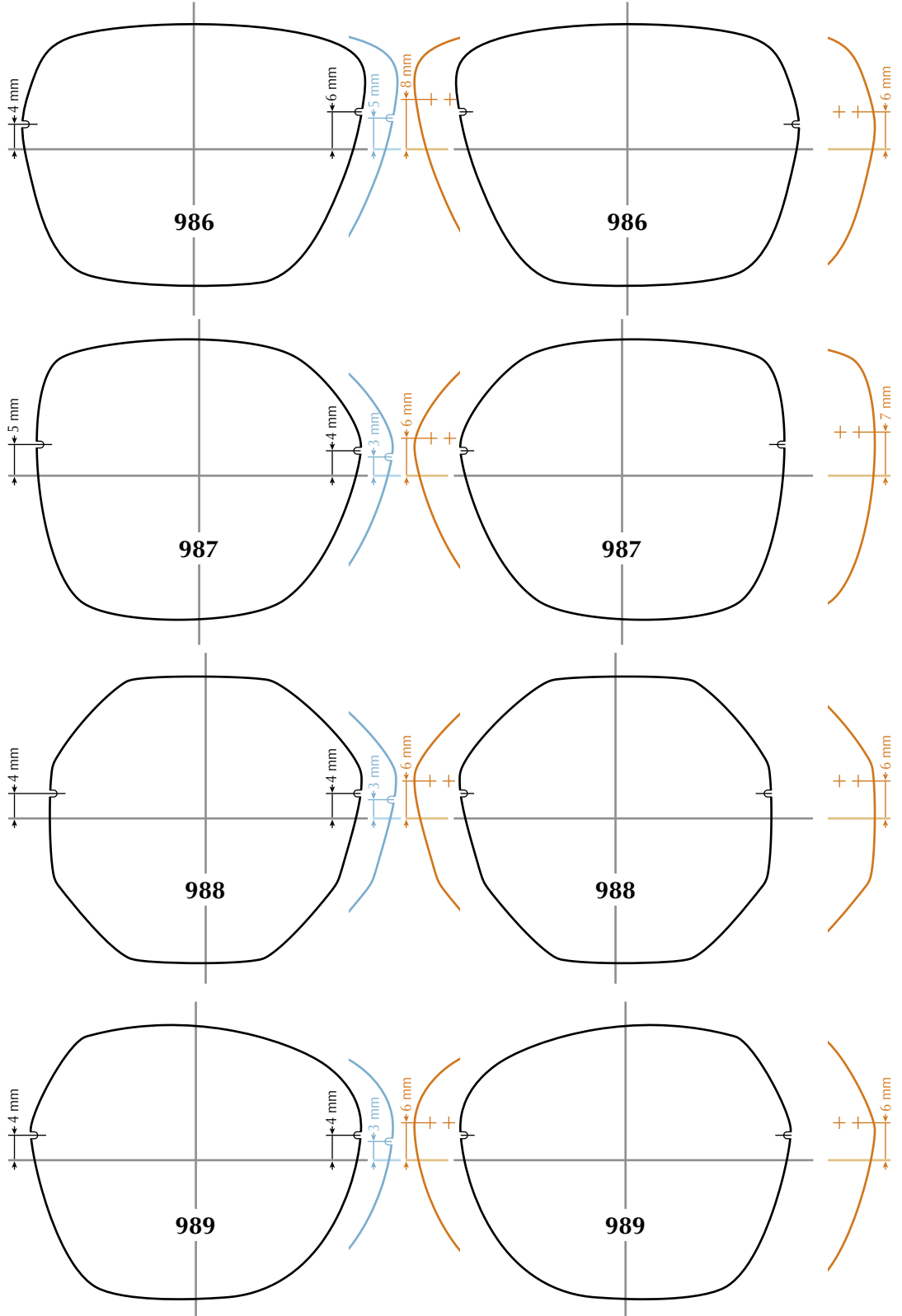
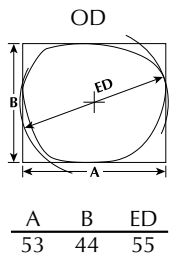
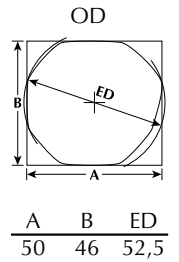
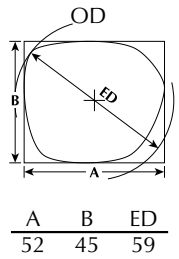
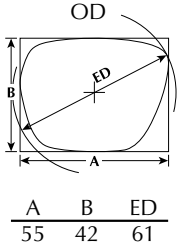

Toutes ces informations sont communiquées à titre indicatif et doivent être adaptées à la forme du nez du porteur.  
All infos provided must be adapted to shape and size of the patient's nose.

⚠ Attention : certaines imprimantes peuvent ne pas reproduire ce document à l'échelle exacte.  
Note: some printers may not duplicate this document at the correct scale.



M-22

Collection "VIS"  
"SCREWS" collection

Pont à vis  
Bridge with screws  
Pont P ou Pont W  
avec selle clipsée  
P bridge or W bridge  
with clipped saddle

Pont W nu  
W bridge bare

Pont à cavaliers  
Plug fit system bridge

Collection "CAVALIERS"  
"WHITOUT SCREWS" collection  
M-10

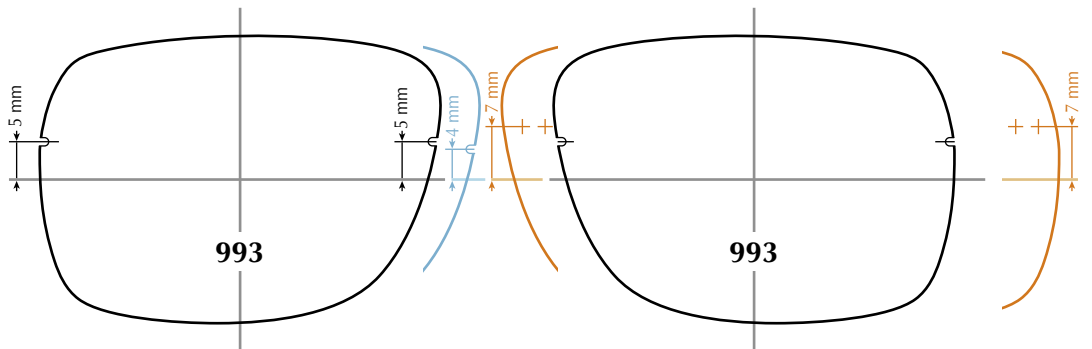
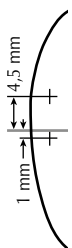
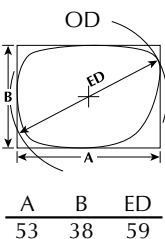
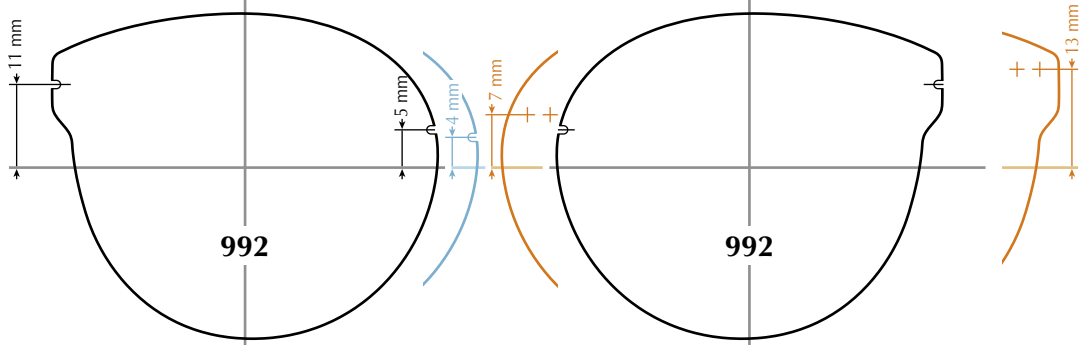
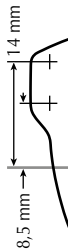
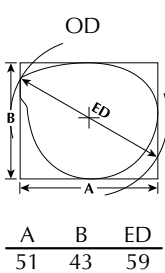
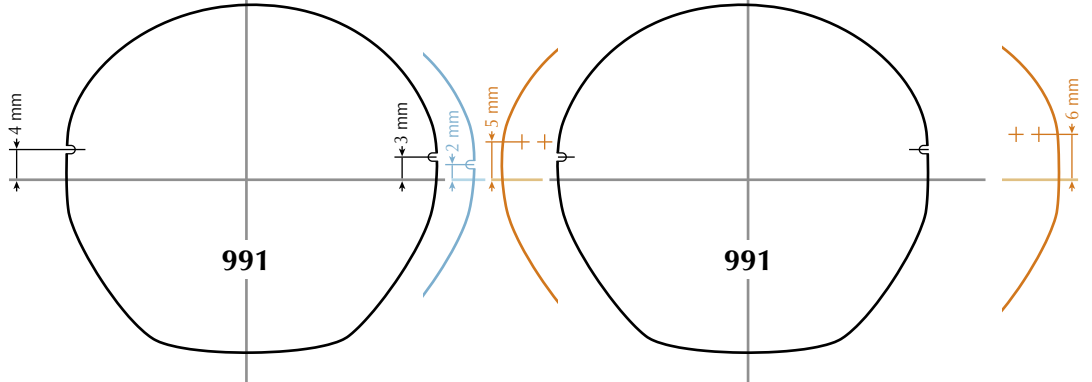
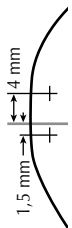
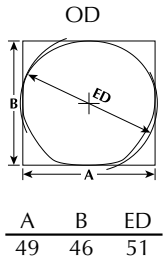
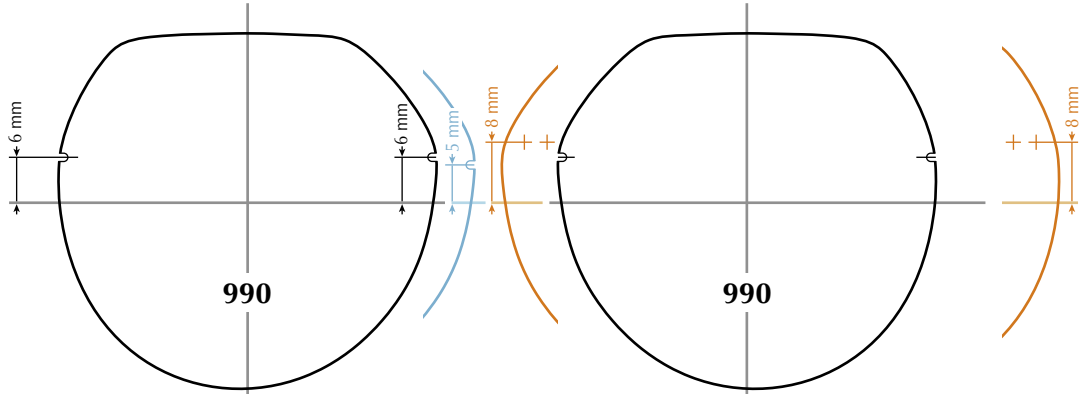
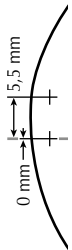
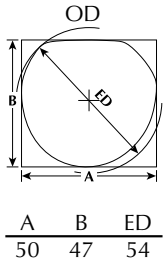

Toutes ces informations sont communiquées à titre indicatif et doivent être adaptées à la forme du nez du porteur.  
All infos provided must be adapted to shape and size of the patient's nose.

⚠ Attention : certaines imprimantes peuvent ne pas reproduire ce document à l'échelle exacte.  
Note: some printers may not duplicate this document at the correct scale.



M-22

Collection "VIS"  
"SCREWS" collection

Pont à vis  
Bridge with screws  
Pont P ou Pont W  
avec selle clipsée  
P bridge or W bridge  
with clipped saddle

Pont W nu  
W bridge bare

Pont à cavaliers  
Plug fit system bridge

Collection "CAVALIERS"  
"WHITOUT SCREWS" collection  
M-10

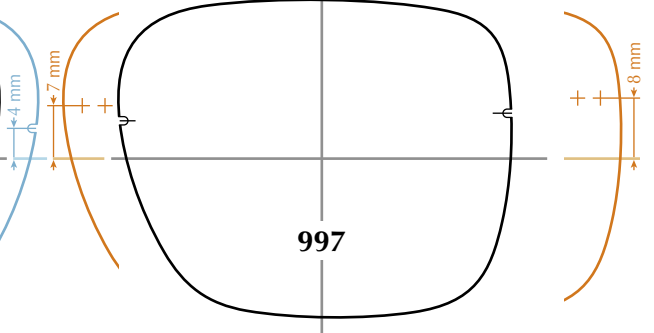
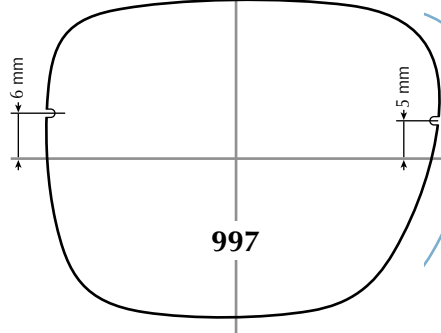
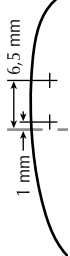
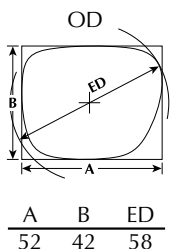
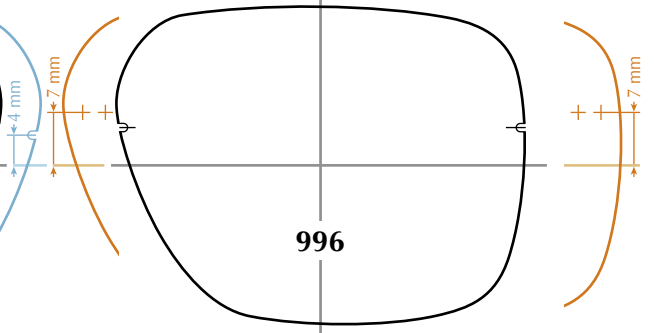
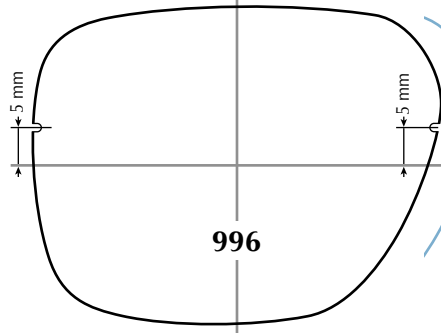
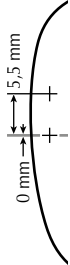
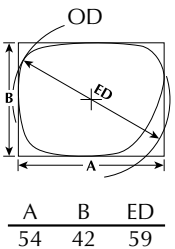
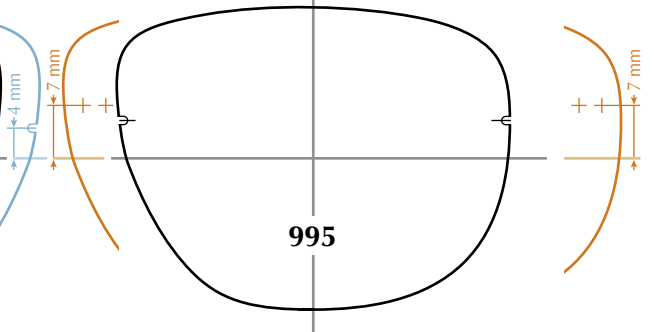
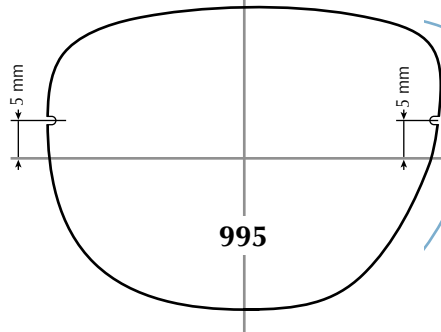
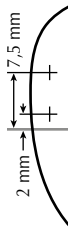
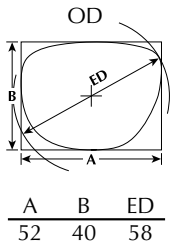
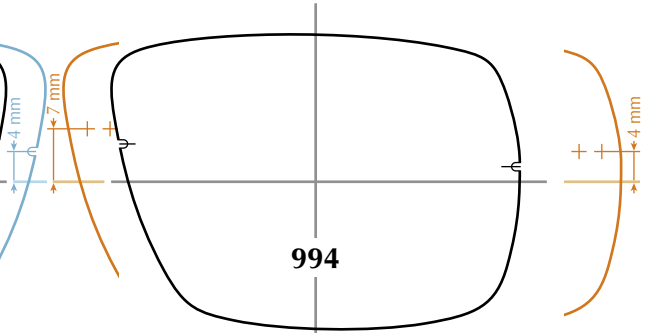
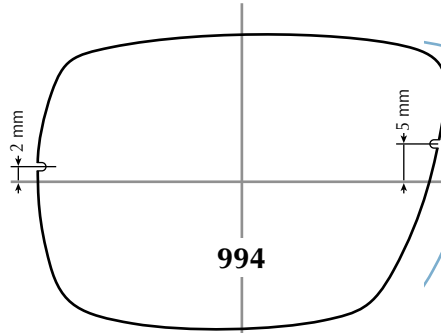
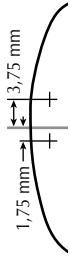
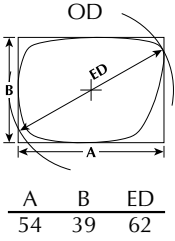

Toutes ces informations sont communiquées à titre indicatif et doivent être adaptées à la forme du nez du porteur.  
All infos provided must be adapted to shape and size of the patient's nose.

⚠ Attention : certaines imprimantes peuvent ne pas reproduire ce document à l'échelle exacte.  
Note: some printers may not duplicate this document at the correct scale.



M-22

Collection "VIS"  
"SCREWS" collection

Pont à vis  
Bridge with screws  
Pont P ou Pont W  
avec selle clipsée  
P bridge or W bridge  
with clipped saddle

Pont W nu  
W bridge bare

Pont à cavaliers  
Plug fit system bridge

Collection "CAVALIERS"  
"WHITOUT SCREWS" collection  
M-10

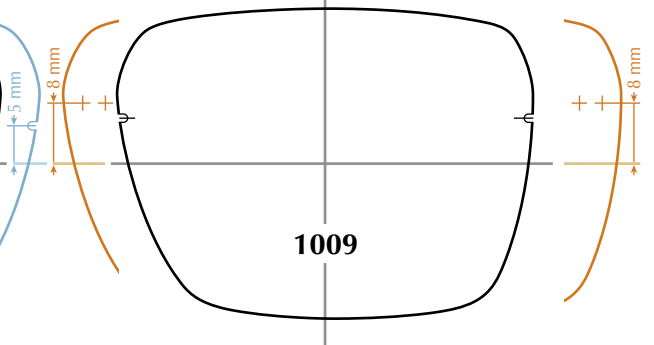
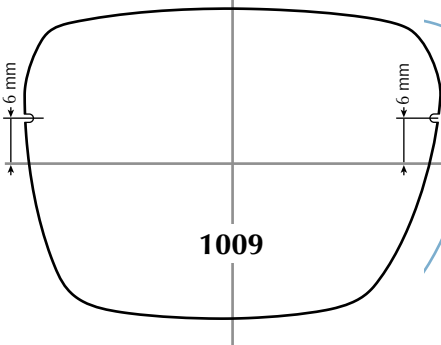
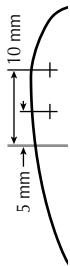
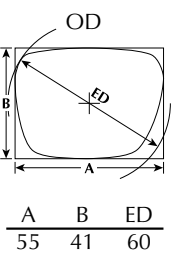
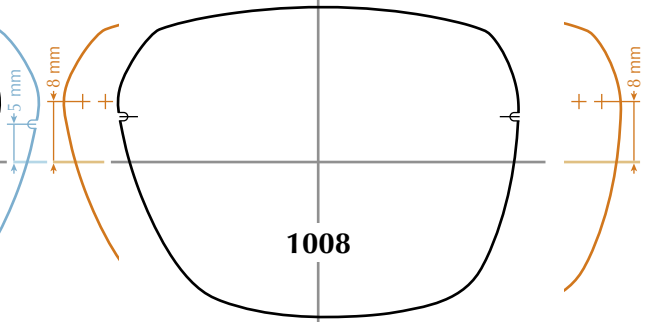
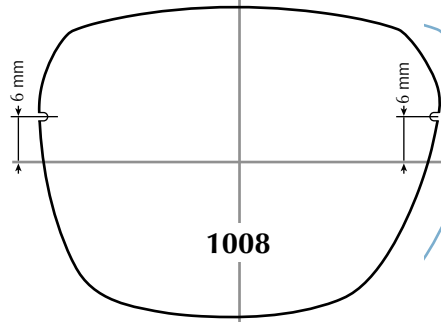
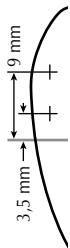
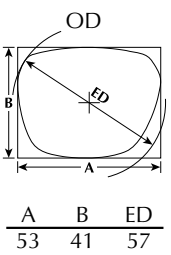
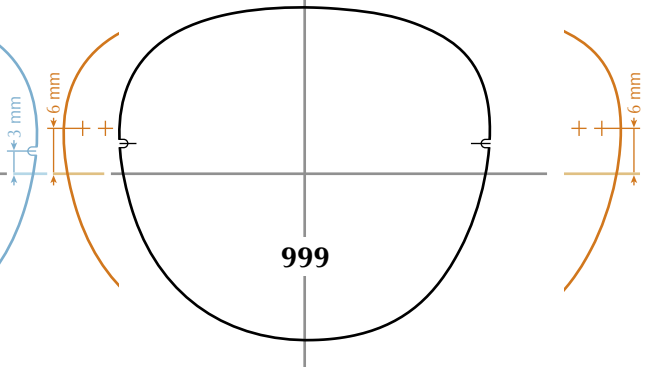
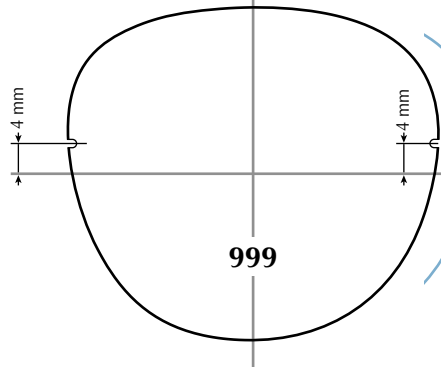
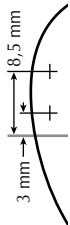
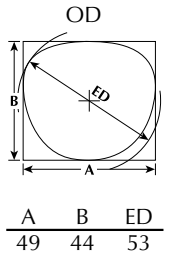
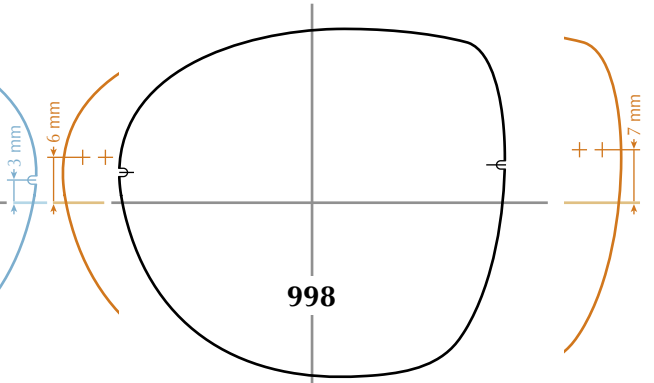
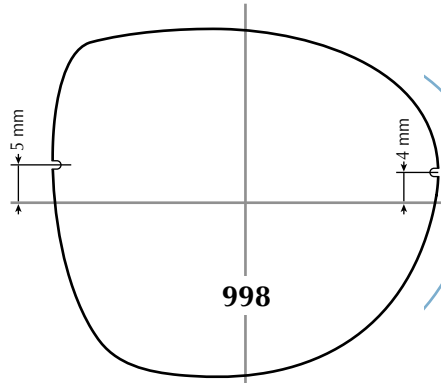
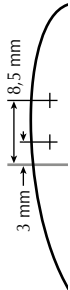
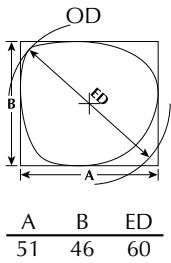

Toutes ces informations sont communiquées à titre indicatif et doivent être adaptées à la forme du nez du porteur.  
All infos provided must be adapted to shape and size of the patient's nose.

⚠ Attention : certaines imprimantes peuvent ne pas reproduire ce document à l'échelle exacte.  
Note: some printers may not duplicate this document at the correct scale.



M-22

Collection "VIS" "SCREWS" collection

Pont à vis  
Bridge with screws  
Pont P ou Pont W  
avec selle clipsée  
P bridge or W bridge  
with clipped saddle

Pont W nu  
W bridge bare

Pont à cavaliers  
Plug fit system bridge

Collection "CAVALIERS"  
"WHITOUT SCREWS" collection  
M-10

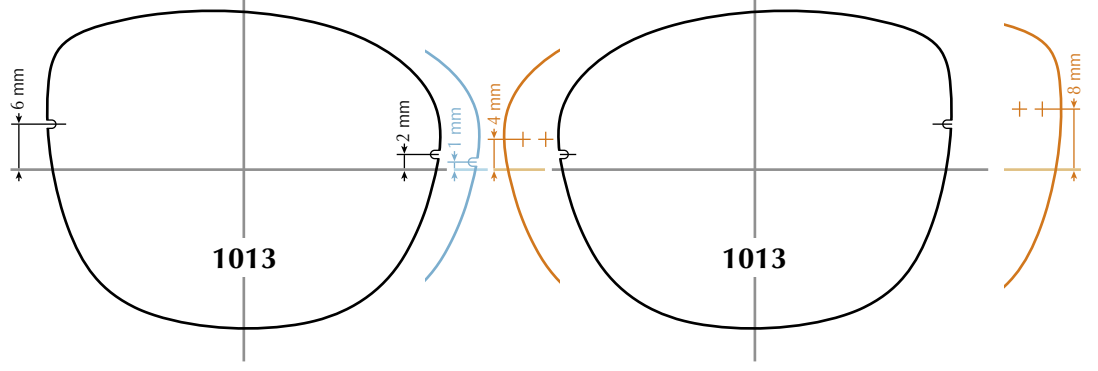
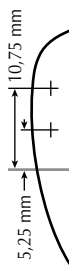
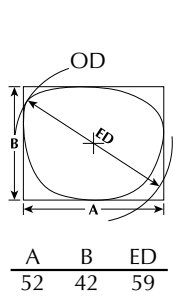
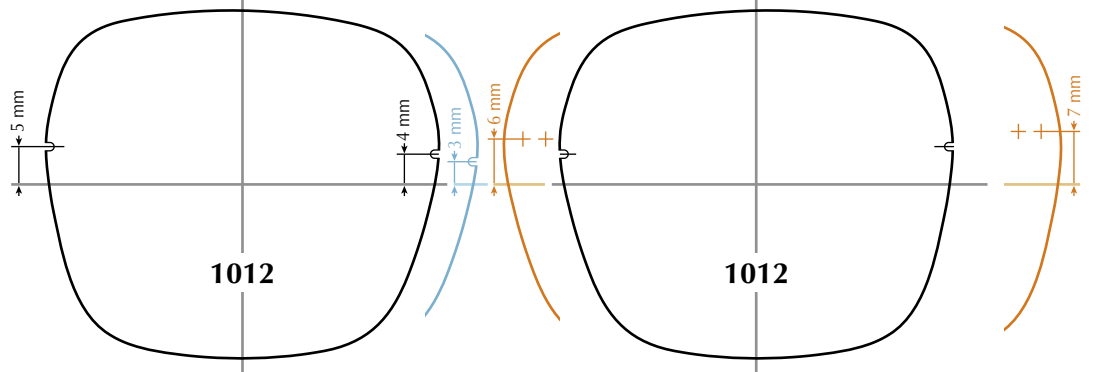
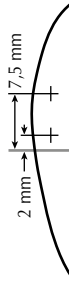
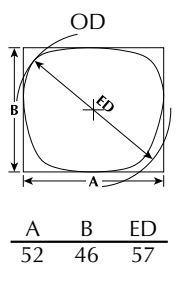
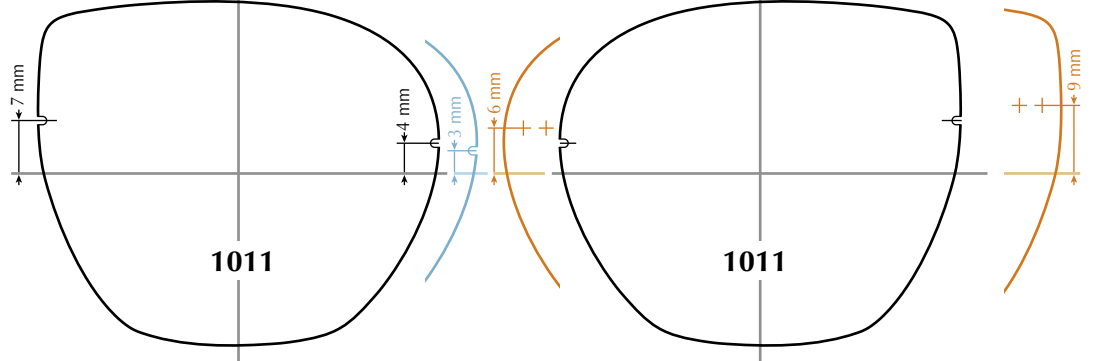
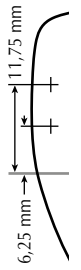
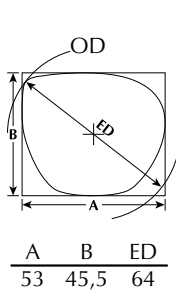
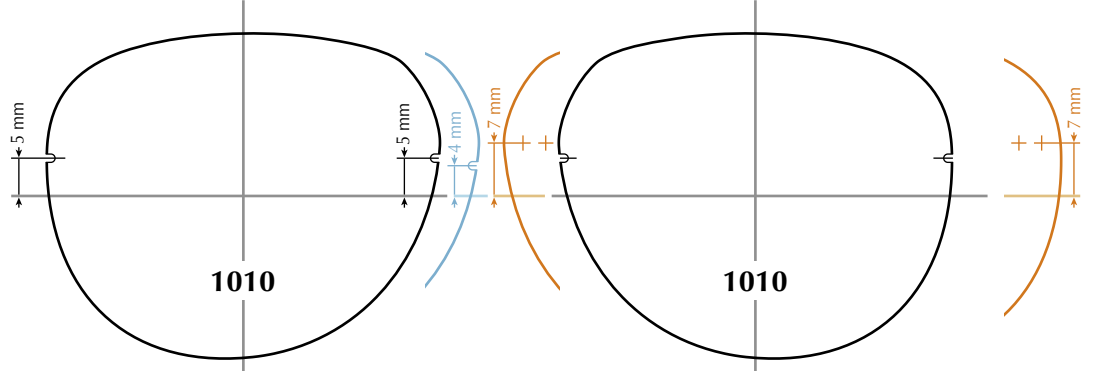
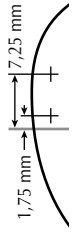
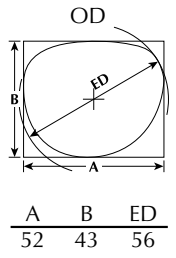

Toutes ces informations sont communiquées à titre indicatif et doivent être adaptées à la forme du nez du porteur.  
All infos provided must be adapted to shape and size of the patient's nose.

⚠ Attention : certaines imprimantes peuvent ne pas reproduire ce document à l'échelle exacte.  
Note: some printers may not duplicate this document at the correct scale.



M-22

Collection "VIS" "SCREWS" collection

Pont à vis Bridge with screws  
Pont P ou Pont W avec selle clipsée  
P bridge or W bridge with clipped saddle

Pont W nu W bridge bare

Pont à cavaliers Plug fit system bridge

Collection "CAVALIERS" "WHITOUT SCREWS" collection M-10

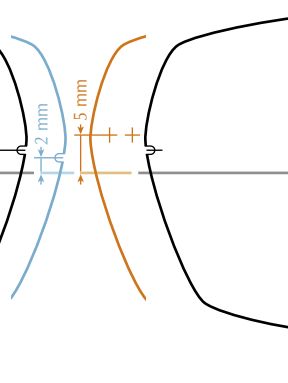
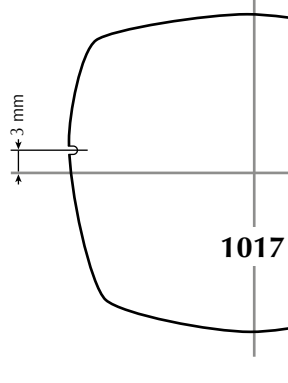
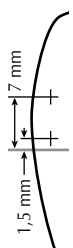
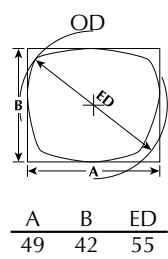
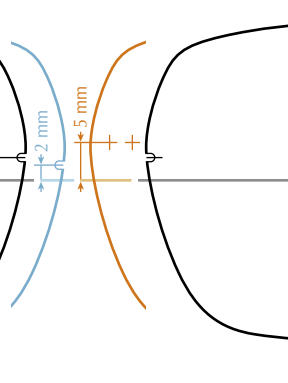
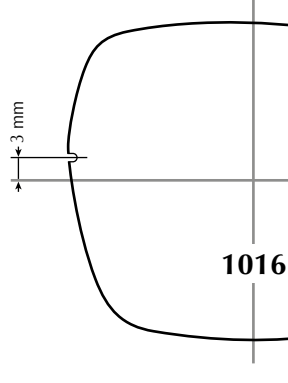
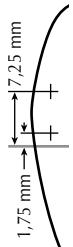
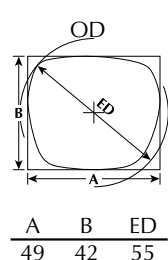
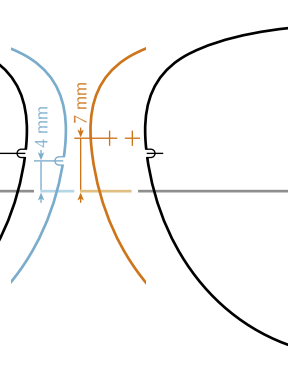
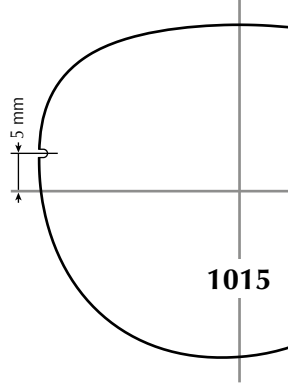
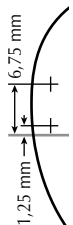
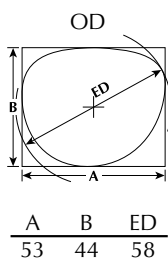
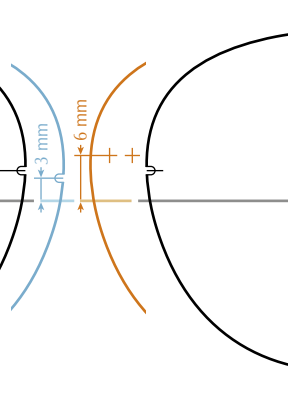
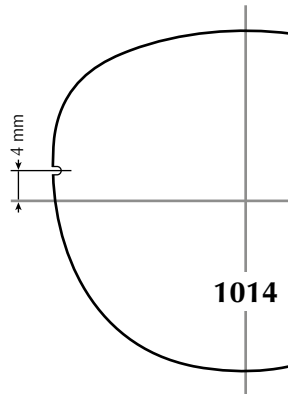
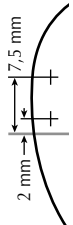
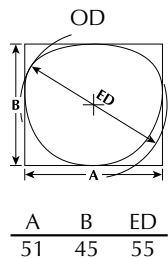

Toutes ces informations sont communiquées à titre indicatif et doivent être adaptées à la forme du nez du porteur.  
All infos provided must be adapted to shape and size of the patient's nose.

⚠ Attention : certaines imprimantes peuvent ne pas reproduire ce document à l'échelle exacte.  
Note: some printers may not duplicate this document at the correct scale.





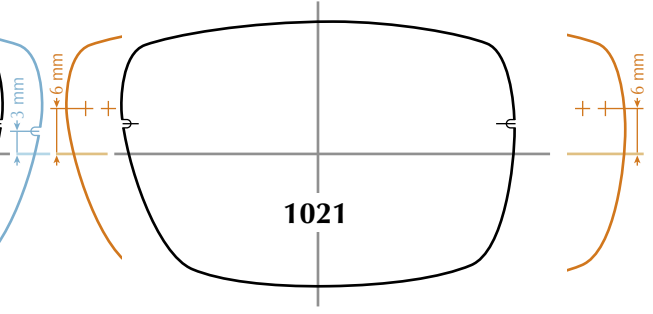
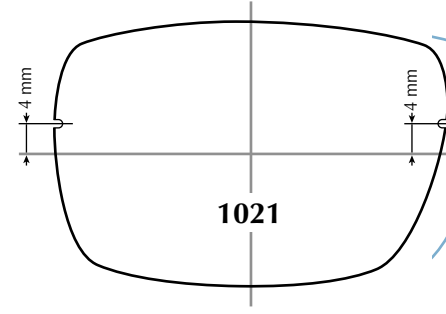
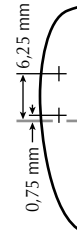
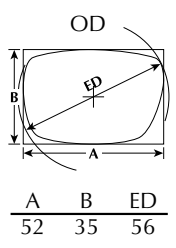
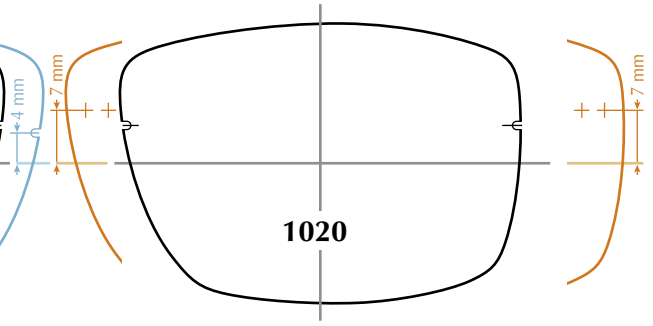
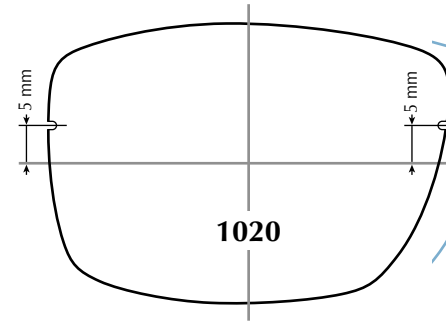
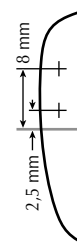
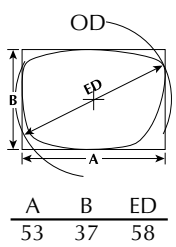
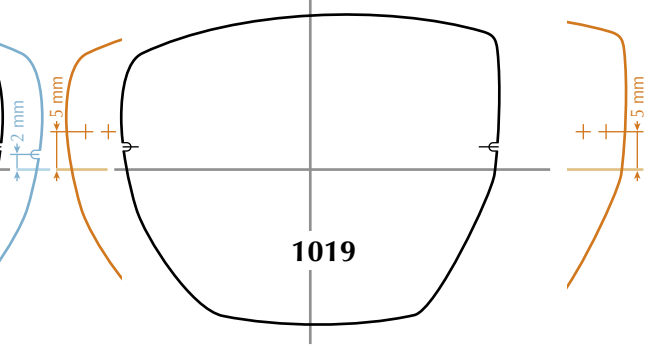
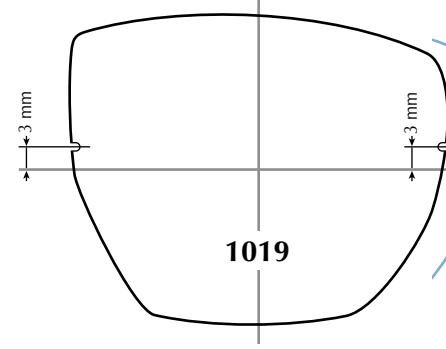
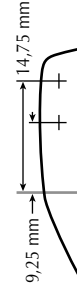
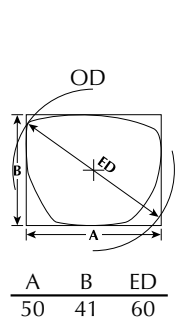
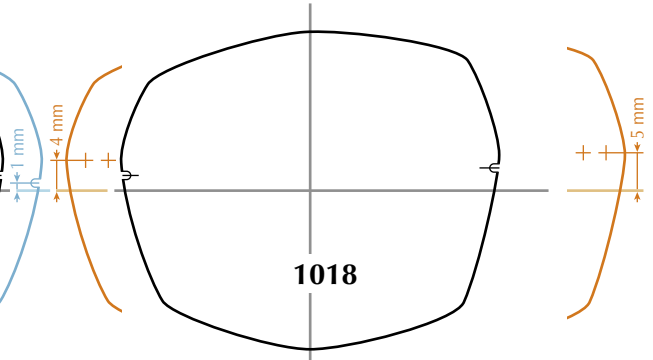
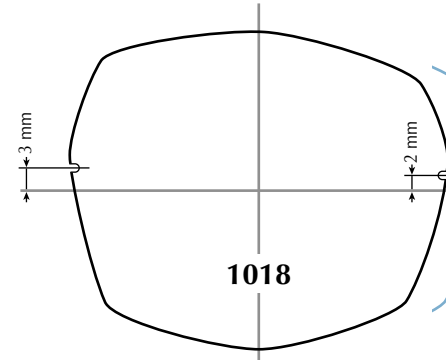
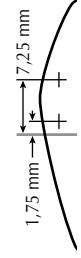
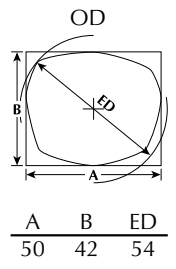
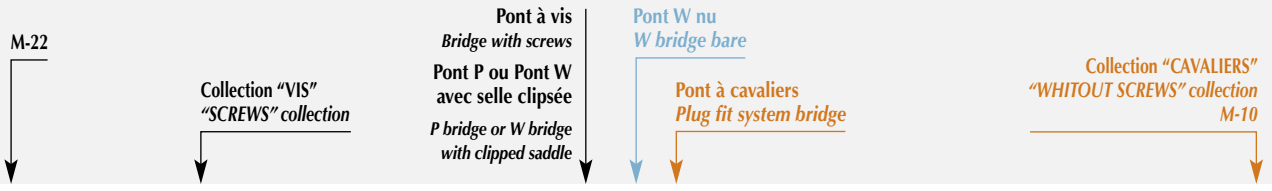

Toutes ces informations sont communiquées à titre indicatif et doivent être adaptées à la forme du nez du porteur.  
 All infos provided must be adapted to shape and size of the patient's nose.

⚠ Attention : certaines imprimantes peuvent ne pas reproduire ce document à l'échelle exacte.  
 Note: some printers may not duplicate this document at the correct scale.



M-22

Collection "VIS" "SCREWS" collection

Pont à vis  
Bridge with screws  
Pont P ou Pont W  
avec selle clipsée  
P bridge or W bridge  
with clipped saddle

Pont W nu  
W bridge bare

Pont à cavaliers  
Plug fit system bridge

Collection "CAVALIERS"  
"WHITOUT SCREWS" collection  
M-10

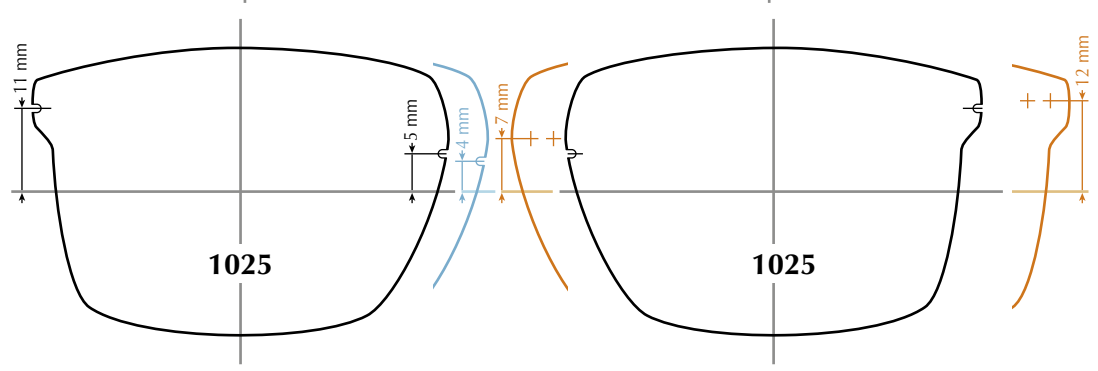
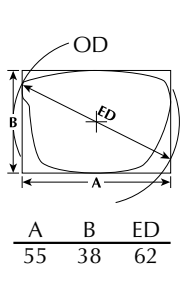
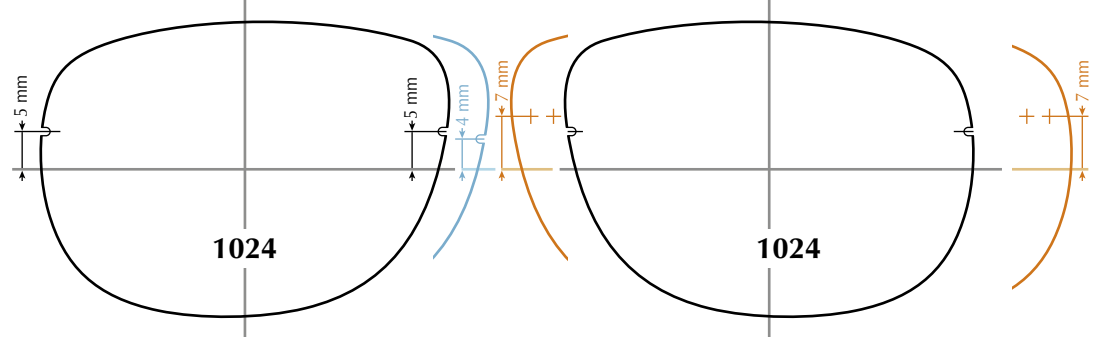
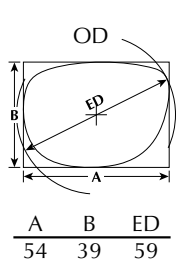
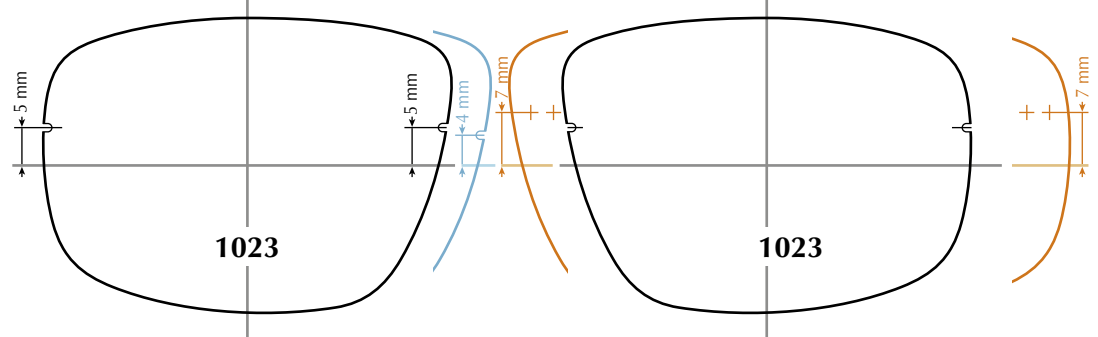
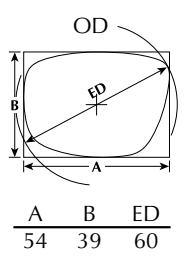
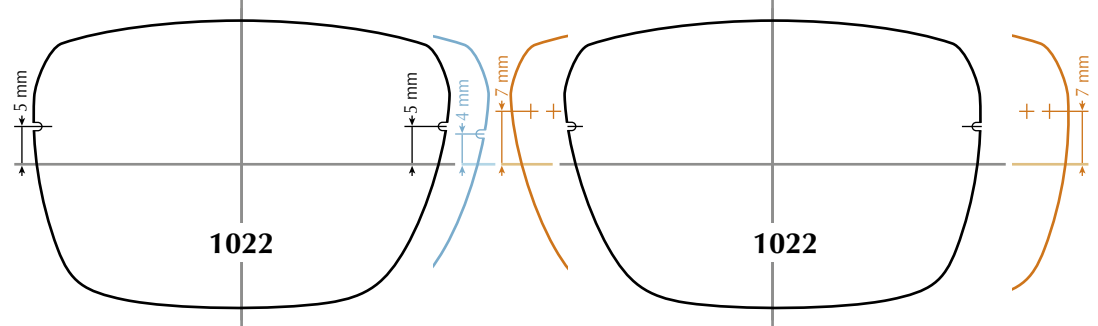
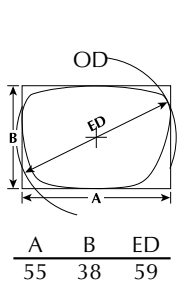

Toutes ces informations sont communiquées à titre indicatif et doivent être adaptées à la forme du nez du porteur.  
All infos provided must be adapted to shape and size of the patient's nose.

⚠ Attention : certaines imprimantes peuvent ne pas reproduire ce document à l'échelle exacte.  
Note: some printers may not duplicate this document at the correct scale.



**FRANCE**

Minima SAS  
4, avenue Delage – 91310 Linas  
Tél.: 01 69 01 03 03  
Fax: 01 69 01 69 19  
commande@minima.fr

**Export**

Tél.: +33 1 64 49 84 39  
Fax: +33 1 64 49 39 92

**DEUTSCHLAND**

Minima GmbH  
Lilienthalstr.8 – 10965 Berlin  
Tel. 030-69817594  
Fax. 030-69817596  
deutschland@minima.fr

**SUISSE**

Minima SAS  
Numéro gratuit : 0800 85 85 87  
export@minima.fr

**BELGIQUE**

Minima SAS  
Numéro vert: 080074926  
export@minima.fr

**UNITED KINGDOM**

Minima SAS  
Free phone number: 0808 234 0103  
export@minima.fr

**CANADA**

Minima SAS  
Tél.: +33 1 64 49 84 39  
export@minima.fr

CONTACT