



BOOK COLLECTION 2024



www.minima.fr

COLLECTION "PERCÉES"

INVISIBLES	P3
INTERCHANGEABLES	P23
TENDANCES	P29

COLLECTION "CERCLÉES"

HYBRID	P41
EVO	P53

COLLECTION "JUNIOR"

JUNIOR	P69
JUNIOR HYBRID	P73
BB HYBRID	P105



COLLECTION "INVISIBLES"









MINIMA-1







ANODISÉE / ANODIZED / ANODIZADA / ELOXIERT / ANODIZADA

01		Bleu clair – Light blue – Azul claro Hellblau – Azul claro	04		Brun foncé – Dark brown mat – Marrón oscuro Dunkelbraun – Castanho escuro	08		Gris – Gray – Gris – Grau – Cinzento
02		Bleu foncé – Dark blue – Azul oscuro Dunkelblau – Azul escuro	05		Brun gris – Brown mat – Marrón Grau-braun – Castanho claro			
03		Bleu roi – Blue – Azul Königsblau – Azul	06		Cuivre – Copper – Cobre – Kupfer – Cobre			

IONISÉE / IONIZED / IONIZADA / IONISIERT / IONIZADA

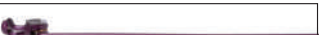
12		2 ors – Two golds – 2 oros Bicolor – 2 ouros	18		Noir brillant – Shiny black – Negro brillante Schwarz glänzend – Preto brilhante	022		Or rose brillant – Shiny pink gold Oro rosa brillante – Roségold glänzend Ouro rosa brilhante
13		Argent – Silver – Plata Silber – Prata	19		Noir mat – Mat black – Negro mate Schwarz matt – Preto baço	2218		
15		Bronze – Bronze – Bronze Bronze – Bronze	20		Or brillant – Shiny gold – Oro brillante Gold glänzend – Ouro brilhante	Or rose brillant/noir brillant – Shiny pink gold/ shiny black – Oro rosa brillante/negro brillante Roségold glänzend/schwarz glänzend Ouro rosa brilhante/preto brilhante		
16		Marine – Navy – Azul marino Marine – Azul marinho	21		Or mat – Mat gold – Oro mate Gold matt – Ouro baço			

LAQUÉES / LACQUERED / LACADO / LACKIERT / LACADA

80		Turquoise – turquoise – Turquesa Türkis – Turquesa	125		Prune – Plum – Ciruela Lila – Roxo	76		Rouge – Red – Rojo Rot – Vermelho
91		Corail – Coral – Coral Koralle – Coral	126		Vert flash – Bright green – Verde vivo Apfelgrün – Verde vivo			











LONGUEUR DE BRANCHES	TENONS
Temple length / Largo de varillas Bugellänge / Tamanho das hastas	Lugs / Talones Backen / Charneiras
146 mm	✓ 10 mm ✓ 15 mm





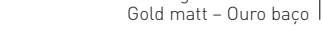

ANODISÉE / ANODIZED / ANODIZADA / ELOXIERT / ANODIZADA

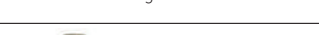
01		Bleu clair – Light blue – Azul claro Hellblau – Azul claro	04		Brun foncé – Dark brown mat Marrón oscuro – Dunkelbraun Castanho escuro	08		Gris – Gray – Gris – Grau – Cinzento
02		Bleu foncé – Dark blue – Azul oscuro Dunkelblau – Azul escuro	05		Brun gris – Brown mat – Marrón Grau-braun – Castanho claro	00		*Titane poli – Polished titanium – Titanio pulido Titan poliert – Titanio polido
03		Bleu roi – Blue – Azul Königsblau – Azul	06		Cuivre – Copper – Cobre – Kupfer – Cobre			

IONISÉE / IONIZED / IONIZADA / IONISIERT / IONIZADA

12		2 ors – Two golds – 2 oros Bicolor – 2 ouros	19		Noir mat – Mat black – Negro mate Schwarz matt – Preto baço	2218		Or rose brillant/noir brillant – Shiny pink gold/ shiny black – Oro rosa brillante/negro brillante Roségold glänzend/schwarz glänzend Ouro rosa brilhante/preto brilhante
13		Argent – Silver – Plata – Silber – Prata	20		Or brillant – Shiny gold – Oro brillante Gold glänzend – Ouro brilhante	OR / GOLD / ORO / GOLD / ORO • 750/1000‰		
15		Bronze – Bronze – Bronce – Bronze – Bronze	21		Or mat – Mat gold – Oro mate Gold matt – Ouro baço			
16		Marine – Navy – Azul marino Marine – Azul marinho	022		Or rose brillant – Shiny pink gold Oro rosa brillante – Roségold glänzend Ouro rosa brilhante	23		Or jaune – Yellow gold – Oro amarillo Gelb gold – Ouro amarelo
18		Noir brillant – Shiny black – Negro brillante Schwarz glänzend – Preto brilhante			24		Or blanc – White gold – Oro blanco Weiss Gold – Ouro branco	

LAQUÉES / LACQUERED / LACADO / LACKIERT / LACADA

80		Turquoise – turquoise – Turquesa Türkis – Turquesa	125		Prune – Plum – Ciruela Lila – Roxo	76		Rouge – Red – Rojo – Rot – Vermelho
91		Corail – Coral – Coral Koralle – Coral	126		Vert flash – Bright green – Verde vivo Apfelgrün – Verde vivo			

LONGUEUR DE BRANCHES

Temple length / Largo de varillas
Bugellänge / Tamanho das hastas

✓ 143 mm

✓ 160 mm*

TENONS

Lugs / Talones
Backen / Charneiras

✓ 10 mm

✓ 15 mm

*

Tenons courts uniquement – Short Lugs only – Talones cortos sólo
Nur kurze Backen – Charneira curta unicamente

MINIMA-3



13	Argent – Silver – Plata – Silber – Prata	28	Graphite – Graphite – Grafito – Graphitgrau – Grafito	00	Titane poli – Polished titanium – Titanio pulido Titan poliert – Titanio polido
15	Bronze – Bronze – Bronce – Bronze – Bronze	104	Vert olive – Olive green – Verde oliva Olivgrün – Verde azeitona	022	Or rose brillant – Shiny pink gold – Oro rosa brillante Roségold glänzend – Ouro rosa brilhante
16	Marine – Navy – Azul marino Marine – Azul marinho	105	Bleu canard – Peacock blue – Azul verdoso Petrol – Verdeado	2218	Or rose brillant/noir brillant – Shiny pink gold/ shiny black – Oro rosa brillante/negro brillante Roségold glänzend/schwarz glänzend Ouro rosa brilhante/preto brilhante
18	Noir brillant – Shiny black – Negro brillante Schwarz glänzend – Preto brilhante	106	Rose vif – Bright pink – Rosa vivo Hellrosa – Rosa vivo	OR / GOLD / ORO / GOLD / ORO 585/1000 ⁰⁰	
19	Noir mat – Mat black – Negro mate Schwarz matt – Preto baço	120	Rouge cerise – Cherry red – Cereza Kirsch rot – Cereza	23	Or jaune – Yellow gold – Oro amarillo Gelb gold – Ouro amarelo
20	Or brillant – Shiny gold – Oro brillante Gold glänzend – Ouro brilhante	224	Bleu gris – Blue grey – Gris azulado Blau-grau – Azul cinza	24	Or blanc – White gold – Oro blanco Weiss Gold – Ouro branco

LONGUEUR DE BRANCHES

Temple length / Largo de varillas
Bugellänge / Tamanho das hastas

145 mm

TENONS

Lugs / Talones
Backen / Charneiras

✓ 10 mm





● Couleur de face / Face color / Color de la cara / Gesichtsfarbe / Cor do osto

G093 
 Gris foncé mat/orange – Mat dark gray/orange
 Gris oscuro mate/naranja – Dunkelgrau matt/orange
 Cinzento escuro baço/laranja

G094 
 Gris foncé mat/rose – Mat dark gray/rose
 Gris oscuro mate/rosa – Dunkelgrau matt/rosa
 Cinzento escuro baço/rosa

G095 
 Gris foncé mat/bleu pastel – Mat dark gray/
 pastel blue – Gris oscuro mate/azul pastel
 Dunkelgrau matt/pastellblau
 Cinzento escuro baço/azul claro

G096 
 Gris foncé mat/aubergine – Mat dark gray/dark
 purple – Gris oscuro mate/violeta oscuro
 Dunkelgrau matt/aubergine
 Cinzento escuro baço/berinjela

99T 
 Gris foncé brillant – Shiny dark gray
 Gris oscuro brillante – Dunkelgrau glänzend
 Cinzento escuro brilhante

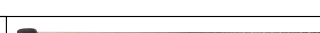
99Y 
 Gris foncé brillant – Shiny dark gray
 Gris oscuro brillante – Dunkelgrau glänzend
 Cinzento escuro brilhante

99Z 
 Gris foncé brillant – Shiny dark gray
 Gris oscuro brillante – Dunkelgrau glänzend
 Cinzento escuro brilhante

● Couleur de face / Face color / Color de la cara / Gesichtsfarbe / Cor do osto

N70 
 Noir/blanc – Black/white – Negro/blanco
 Schwarz/weiß – Preto/branco

N76 
 Noir/rouge – Black/red – Negro/rojo
 Schwarz/rot – Preto/vermelho

N145 
 Noir/prune – Black/plum – Negro/ciruela
 Schwarz/lila – Preto/roxo

NO13 
 Noir/argent brillant – Black/shiny silver
 Negro/plata brillante – Schwarz/silber glänzend
 Preto/prata brilhante

N022 
 Noir/or rose brillant – Black/shiny pink gold
 Negro/oro rosa brillante – Schwarz/
 roségold glänzend – Preto/ouro rosa brilhante

N042 
 Noir/framboise foncé – Black/dark raspberry
 Negro/frambuesa oscura – Schwarz/
 dark raspberry – Preto/framboesa escura

18U 
 Noir brillant – Shiny black – Negro brilhante
 Schwarz glänzend – Preto brilhante

18W 
 Noir brillant – Shiny black – Negro brilhante
 Schwarz glänzend – Preto brilhante

18X 
 Noir brillant – Shiny black – Negro brilhante
 Schwarz glänzend – Preto brilhante

NR22 
 Noir/or rose brillant – Black/shiny pink gold
 Negro/oro rosa brillante – Schwarz/
 roségold glänzend – Preto/ouro rosa brilhante

● Couleur de face / Face color / Color de la cara / Gesichtsfarbe / Cor do osto

R037 
 Or rose brossé – Pink gold brushed
 Oro rosa cepillado – Roségold gebürstet
 Ouro rosa escovado

R22 
 Or rose/or rose brillant – Pink gold/shiny pink gold
 Oro rosa/oro rosa brillante – Roségold/roségold
 glänzend – Ouro rosa/ouro rosa brilhante

R74 
 Or rose/noir – Pink gold/black
 Oro rosa/negro – Roségold/schwarz
 Ouro rosa/preto

LONGUEUR DE BRANCHES

Temple length / Largo de varillas
 Bugellänge / Tamanho das hastes

144 mm

MINIMA-5/5C

● Couleur de face / Face color / Color de la cara / Gesichtsfarbe / Cor do ostio

O020 Or/or brillant – Gold/shiny gold – Oro/oro brillante Gold/gold glänzend – Ouro/ouro brilhante	O033 Or/or brossé – Gold/gold brushed Oro/oro cepillado – Gold/gold gebürstet Ouro/ouro escovado	O040 Or/gun brossé – Gold/gun brushed Oro/gun cepillado – Gold/gun gebürstet Ouro/gun escovado
O18 Or/noir brillant – Gold/shiny black Oro/negro brillante – Gold/schwarz glänzend Ouro/preto brilhante	O35 Or/noir brossé – Gold/black brushed Oro/negro cepillado – Gold/schwarz gebürstet Ouro/preto escovado	20T Or brillant – Shiny gold – Oro brillante Gold glänzend – Ouro brilhante
20U Or brillant – Shiny gold – Oro brillante Gold glänzend – Ouro brilhante	20W Or brillant – Shiny gold – Oro brillante Gold glänzend – Ouro brilhante	20X Or brillant – Shiny gold – Oro brillante Gold glänzend – Ouro brilhante
20Y Or brillant – Shiny gold – Oro brillante Gold glänzend – Ouro brilhante	20Z Or brillant – Shiny gold – Oro brillante Gold glänzend – Ouro brilhante	OR13 Or/argent brillant – Gold/shiny silver Oro/plata brillante – Gold/silber glänzend Ouro/prata brilhante

● Couleur de face / Face color / Color de la cara / Gesichtsfarbe / Cor do ostio

T35 Titane poli/noir brossé – Polished titanium/ black brushed – Titanio pulido/negro cepillado Titan poliert/schwarz gebürstet Titanio polido/preto escovado	T71 Titane poli/bleu nuit – Polished titanium/ night blue – Titanio pulido/azul oscuro Titan poliert/nachtblau – Titanio polido/azul escuro	T73 Titane poli/gris – Polished titanium/gray Titanio pulido/gris – Titan poliert/grau Titanio polido/cinzeno
T74 Titane poli/noir – Polished titanium/black Titanio pulido/negro – Titan poliert/schwarz Titanio polido/preto	T75 Titane poli/noisette – Polished titanium/hazelnut Titanio pulido/avellana – Titan poliert/haselnußbraun Titanio polido/côr de avelã	T76 Titane poli/rouge – Polished titanium/red Titanio pulido/rojo – Titan poliert/rot Titanio polido/vermelho
T013 Titane poli/argent brillant – Polished titanium/ shiny silver – Titanio pulido/plata brillante Titan poliert/silber glänzend – Titanio polido/ prata brilhante	T033 Titane poli/or brossé – Polished titanium/ gold brushed – Titanio pulido/oro cepillado Titan poliert/gold gebürstet – Titanio polido/ ouro escovado	T034 Titane poli/argent brossé – Polished titanium/ silver brushed – Titanio pulido/plata cepillado Titan poliert/silber gebürstet Titanio polido/prata escovado
T097 Titane poli/marron – Polished titanium/brown Titanio pulido/marrón – Titan poliert/braun Titanio polido/castanho	T098 Titane poli/turquoise – Polished titanium/turquoise Titanio pulido/turquesa – Titan poliert/türkis Titanio polido/turquesa	T13T Titane poli/argent brillant – Polished titanium/ shiny silver – Titanio pulido/plata brillante Titan poliert/silber glänzend – Titanio polido/ prata brilhante
T13U Titane poli/argent brillant – Polished titanium/ shiny silver – Titanio pulido/plata brillante Titan poliert/silber glänzend – Titanio polido/ prata brilhante	T13W Titane poli/argent brillant Polished titanium/shiny silver – Titanio pulido/ plata brillante – Titan poliert/silber glänzend Titanio polido/prata brilhante	T13X Titane poli/argent brillant Polished titanium/shiny silver – Titanio pulido/ plata brillante – Titan poliert/silber glänzend Titanio polido/prata brilhante
T13Y Titane poli/argent brillant Polished titanium/shiny silver – Titanio pulido/ plata brillante – Titan poliert/silber glänzend Titanio polido/prata brilhante		

● Couleur de face / Face color / Color de la cara / Gesichtsfarbe / Cor do ostio

GP35 Graphite/noir brossé – Graphite/black brushed Grafito/negro cepillado – Graphitgrau/ schwarz gebürstet – Grafito/preto escovado
--

● Couleur de face / Face color / Color de la cara / Gesichtsfarbe / Cor do ostio

15 Bronze – Bronze – Bronze – Bronze – Bronze

LONGUEUR DE BRANCHES

Temple length / Largo de varillas
Bugellänge / Tamanho das hastes

144 mm

MINIMA-5/5C STRASS



● Argent brillant / Shiny silver / Plata brillante / Silver glänzend / Prata brilhante



1360

Strass cristal
Crystal strass
Strass cristal
Strass kristall
Strass cristal



1361

Strass aqua
Aqua strass
Strass aqua
Strass wasserbla
Strass aqua



1362

Strass vert foncé
Dark green strass
Strass verde oscuro
Strass dunkelgrün
Strass verde escuro



1363

Strass bleu violet
Blue purple strass
Strass azul violeta
Strass blau violett
Strass azul violeta

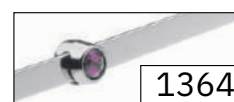

1364

Strass fuchsia
Fuchsia strass
Strass fucsia
Strass fuchsia
Strass fuchsia

● Or brillant / Shiny gold / Oro brillante / Gold glänzend / Ouro brilhante



2050

Strass cristal
Crystal strass
Strass cristal
Strass kristall
Strass cristal



2051

Strass or
Gold strass
Strass oro
Strass gold
Strass ouro



2052

Strass noir
Black strass
Strass negro
Strass schwarz
Strass preto



2053

Strass rouge
Red strass
Strass rojo
Strass rot
Strass vermelho



2054

Strass vert foncé Dark
green strass Strass
verde oscuro Strass
dunkelgrün Strass
verde escuro

● Or rose brillant / Shiny pink gold / Oro rosa brillante / Roségold glänzend / Ouro rosa brilhante



2255

Strass cristal
Crystal strass
Strass cristal
Strass kristall
Strass cristal



2256

Strass vintage rose
Vintage rose strass
Strass rosa vintage
Strass vintage rosa
Strass rosa vintage



2257

Strass gris
Gray strass
Strass gris
Strass grau
Strass cinzento



2258

Strass noir
Black strass
Strass negro
Strass schwarz
Strass preto



2259

Strass violet
Purple strass
Strass violeta
Strass violett
Strass violeta

LONGUEUR DE BRANCHES



Temple length / Largo de varillas
Bugellänge / Tamanho das hastas

144 mm







0001  
 Titane poli/cristal – Polished titanium/crystal
 Titanio pulido/cristal – Titan poliert/kristall
 Titanio polido/cristal



1192  
 Châtaigne/noir – Chestnut/black
 Castaño/negro – Kastanienbraune/schwarz
 Castanha/preto



1802  
 Noir brillant/noir – Shiny black/black
 Negro brillante/negro – Schwarz glänzend/
 schwarz – Preto brilhante/preto



0002  
 Titane poli/noir – Polished titanium/black
 Titanio pulido/negro – Titan poliert/schwarz
 Titanio polido/preto

1212  
 Indigo/noir – Indigo/black – Índigo/negro
 Indigoblau/schwarz – Índigo/preto



2001  
 Or brillant/cristal – Shiny gold/crystal
 Oro brillante/cristal – Gold glänzend/kristall
 Ouro brilhante/cristal



0003  
 Titane poli/bleu translucide – Polished titanium/
 translucent blue – Titanio pulido/azul translúcido
 Titan poliert/blau transparent
 Titanio polido/azul translucido

1222  
 Bleu glacier/noir – Ice blue/black
 Azul glaciador/negro – Eisblau/schwarz
 Azul glaciador/preto

2201  
 Or rose brillant/cristal – Shiny pink gold/crystal
 Oro rosa brillante/cristal – Roségold glänzend/
 kristall – Ouro rosa brilhante/cristal



1012  
 Brun gris/noir – Brown mat/black - Marrón/negro
 Grau-braun/schwarz – Castanho claro/preto

1232  
 Rose pastel/noir – Pastel pink/black
 Rosa pastel/negro – Pastellrosa/schwarz
 Rosa pastel/preto

2218  
 Or rose brillant/noir brillant – Shiny pink gold/
 shiny black – Oro rosa brillante/negro brillante
 Roségold glänzend/schwarz glänzend
 Ouro rosa brilhante/preto brilhante



1052  
 Bleu canard/noir – Peacock blue/black
 Azul verdoso/negro – Petrol/schwarz
 Verdeado/preto

1502  
 Bronze/noir – Bronze/black – Bronce/negro
 Bronze/schwarz – Bronze/preto

5202  
 Bleu colonial/noir – Colonial blue/black
 Azul colonial/negro – Kolonialblau/schwarz
 Azul colonial/preto

9002  
 Bleu clair/noir - Light blue/black
 Azul claro/negro – Hellblau/schwarz
 Azul claro/preto

7902  
 Gris clair/noir - Light gray/black
 Gris claro/negro – Hellgrau/schwarz
 Cinzento claro/preto

5502  
 Bordeaux/noir – Burgundy/black
 Rojo-violáceo/negro – Weinrot/schwarz
 Bordeaux/preto

7602  
 Rouge/noir - Red/black – Rojo/negro
 Rot/schwarz – Vermelho/preto

5802  
 Lilas/noir – Lilac/black – Lila/negro
 Lila/schwarz – Lilàs/preto

7802  
 Violet foncé/noir - Dark purple/black
 Violeta oscuro/negro - Dunkelviolett/schwarz
 Violeta escuro/preto

LONGUEUR DE BRANCHES

Temple length / Largo de varillas
 Bugellänge / Tamanho das hastes

148 mm

Diabolos + manchons/coloris assortis
 Diabolo + temple ends/same colours
 Diabolo + terminales/cores similares
 Diabolos + bugelende/sortierte farben
 Diabolos + ponteiros/cores sortidas



N101

180002

Noir brillant/titane poli/noir
Shiny black/polished titanium/black
Negro brillante/titanio pulido/negro
Schwarz glänzend/titan poliert/schwarz
Preto brilhante/titanio polido/preto

7902

Gris clair/noir - Light gray/black
Gris claro/negro - Hellgrau/schwarz
Cinzeno claro/preto



N102

7602

Rouge/noir - Red/black
Rojo/negro - Rot/schwarz
Vermelho/preto



N103

9002

Bleu clair/noir - Light blue/black
Azul claro/negro - Hellblau/schwarz
Azul claro/preto

1802

Noir brillant/noir - Shiny black/black
Negro brillante/negro - Schwarz glänzend/
schwarz - Preto brilhante/preto



N104

2001

Or brillant/cristal - Shiny gold/crystal
Oro brillante/cristal - Gold glänzend/kristall
Ouro brilhante/cristal

LONGUEUR DE BRANCHES

Temple length / Largo de varillas
Bugellänge / Tamanho das hastas

148 mm

PONTS EUROPE

European bridge / Puente europeo
Europäischer Nasensteg / Ponte Europa

XS S M L XL

PONTS ASIE

Asian bridge / Puente asiático
Asiatischer Nasensteg / Ponte Àsia

XS S M L XL

MINIMA-9C / SERIE2



1802 
 Noir brillant/noir – Shiny black/black
 Negro brillante/negro – Schwarz glänzend/
 schwarz – Preto brilhante/preto

7802 
 Violet foncé/noir - Dark purple/black
 Violeta oscuro/negro - Dunkelviolett/schwarz
 Violeta escuro/preto



1502 
 Bronze/noir – Bronze/black
 Bronce/negro – Bronze/schwarz
 Bronze/preto

7602 
 Rouge/noir - Red/black
 Rojo/negro – Rot/schwarz
 Vermelho/preto



9002 
 Bleu clair/noir - Light blue/black
 Azul claro/negro – Hellblau/schwarz
 Azul claro/preto

189202 
 Noir brillant/rose pâle/noir
 Shiny black/pale rose/black
 Negro brillante/rosa pálido/negro
 Schwarz glänzend/hellrosa/schwarz
 Preto brilhante/rosa claro/preto

LONGUEUR DE BRANCHES
 Temple length / Largo de varillas
 Bugellänge / Tamanho das hastas
 148 mm

PONTS EUROPE
 European bridge / Puente europeo
 Europäischer Nasensteg / Ponte Europa
 XS S M L XL

PONTS ASIE
 Asian bridge / Puente asiático
 Asiatischer Nasensteg / Ponte Àsia
 XS S M L XL

① F982

MINIMA-11C / DM1



A	B	ED
55	44	57.30



5001

Argent brossé/titane poli/bleu nuit
Silver brushed/polished titanium/night blue
Plata cepillado/titanio pulido/azul oscuro Silber
gebürstet/titan poliert/nachtblau Prata
escovada/titanio polido/azul escuro



5002

Or brossé/titane poli/or brossé
Gold brushed/polished titanium/brushed gold
Oro cepillado/titanio pulido/oro cepillado
Gold gebürstet/titan poliert/gold gebürstet
Ouro escovado/titanio polido/ouro escovado



5003

Gun brossé/titane poli/gun brossé
Gun brushed/polished titanium/gun black Gun
cepillado/titanio pulido/gun cepillado Gun
gebürstet/titan poliert/gun gebürstet Gun
escovado/titanio polido/gun escovado

① F980

MINIMA-11C / DM2



A	B	ED
52	46.5	53.6



5004

Argent brillant/or/argent brillant
Shiny silver/gold/shiny silver
Plata brillante/oro/plata brillante
Silber glänzend/gold/glänzendes silber
Prata brilhante/ouro/prata brilhante



5005

Or rose brillant/or rose/noir/or rose brillant
Shiny pink gold/pink gold/black/shiny rose gold
Oro rosa brillante/oro rosa/negro/
oro rosa brillante
Glänzendes roségold/roségold/schwarz/
roségold glänzend
Ouro rosa brilhante/ouro rosa/preto/
ouro rosa brilhante



5006

Noir brillant/or/noir brillant
Shiny black/gold/shiny black
Negro brillante/oro/negro brillante
Schwarz glänzend/gold/schwarz glänzend
Preto brilhante/ouro/preto brilhante

PONTS EUROPE

European bridge / Puente europeo
Europäischer Nasensteg / Ponte Europa

XS
 S

PONTS ASIE

Asian bridge / Puente asiático
Asiatischer Nasensteg / Ponte Ásia

XS
 S

LONGUEUR DE BRANCHES

Temple length / Largo de varillas
Bugellänge / Tamanho das hastas 144 mm

① F981

MINIMA-11C / DM3



A	B	ED
49	46	51.7



5007

Gun brossé/or/gun brossé
Gun brushed/gold/gun brushed
Gun cepillado/oro/gun cepillado
Gun gebürstet/gold/gun gebürstet
Gun escovada/ouro/gun escovada

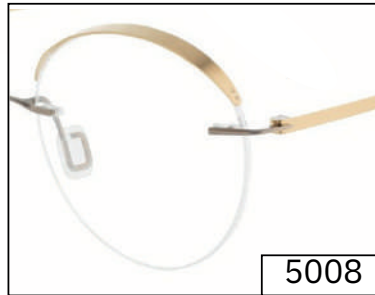

5008

Or brossé/titane poli/or brossé
Gold brushed/polished titanium/brushed gold
Oro cepillado/titanio pulido/oro cepillado
Gold gebürstet/titan poliert/gold gebürstet
Ouro escovado/titanio polido/ouro escovado



5009

Or rose brillant/or rose/noir/or rose brillant
Shiny pink gold/pink gold/black/shiny rose gold
Oro rosa brillante/oro rosa/negro/oro rosa brillante
Roségold glänzend/roségold/schwarz/
roségold glänzend
Ouro rosa brilhante/ouro rosa/preto/
ouro rosa brilhante

① F966

MINIMA-11C / DM4



A	B	ED
50	48.5	50.8



5010

Noir brillant/or/noir brillant
Shiny black/gold/shiny black
Negro brillante/oro/negro brillante
Schwarz glänzend/gold/schwarz glänzend
Preto brilhante/ouro/preto brilhante



5011

Or rose brillant/or rose/noir/or rose brillant
Shiny pink gold/pink gold/black/shiny rose gold
Oro rosa brillante/oro rosa/negro/
oro rosa brillante
Roségold glänzend/roségold/schwarz/
roségold glänzend
Ouro rosa brilhante/ouro rosa/preto/
ouro rosa brilhante



5012

Rouge foncé/or/or brossé
Dark red/gold/brushed gold
Rojo oscuro/oro/oro cepillado
Dunkelrot/gold/gold gebürstet
Vermelho escuro/ouro/ouro escovado

PONTS EUROPE

European bridge / Puente europeo
Europäischer Nasensteg / Ponte Europa

XS
 S

PONTS ASIE

Asian bridge / Puente asiático
Asiatischer Nasensteg / Ponte Àsia

XS
 S

LONGUEUR DE BRANCHES

Temple length / Largo de varillas
Bugellänge / Tamanho das hastas 144 mm

① F964

MINIMA-11C / DM5



A	B	ED
51	42.5	53.4



5013

Or rose brillant/noir/or rose brillant
Shiny pink gold/black/shiny rose gold
Oro rosa brillante/negro/oro rosa brillante
Roségold glänzend/schwarz/roségold glänzend
Ouro rosa brilhante/preto/ouro rosa brilhante



5014

Argent brillant/noir/argent brillant
Shiny silver/black/shiny silver
Plata brillante/negro/plata brillante
Silber glänzend/schwarz/silber glänzend
Prata brilhante/preto/prata brilhante



5015

Framboise foncé/noir/framboise foncé
Dark raspberry/black/dark raspberry
Frambuesa oscura/negro/frambuesa oscura
Dark raspberry/schwarz/dark raspberry
Framboesa escura/preto/framboesa escura

① F983

MINIMA-11C / DM6



A	B	ED
55	45	59.2



5016

Or brossé/or/or brossé
Gold brushed/gold/gold brushed
Oro cepillado/oro/oro cepillado
Gold gebürstet/gold/gold gebürstet
Ouro escovado/ouro/ouro escovado



5017

Gun brossé/graphite/gun brossé
Gun brushed/graphite/gun brushed
Gun cepillado/grafito/gun cepillado
Gun gebürstet/graphitgrau/gun gebürstet
Gun escovado/grafito/gun escovado

PONTS EUROPE

European bridge / Puente europeo
Europäischer Nasensteg / Ponte Europa

XS
 S

PONTS ASIE

Asian bridge / Puente asiático
Asiatischer Nasensteg / Ponte Àsia

XS
 S

LONGUEUR DE BRANCHES

Temple length / Largo de varillas
Bugellänge / Tamanho das hastas 144 mm

① F980

MINIMA-11C / DP1



A	B	ED
52	46.5	53.6

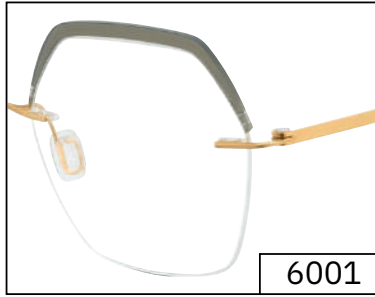

6001

Or brossé/or/gris
Gold brushed/gold/gray
Oro cepillado/oro/gris
Gold gebürstet/gold/gris
Ouro escovado/ouro/gris

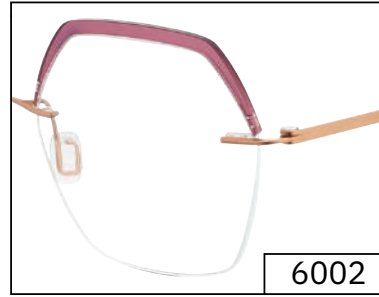

6002

Or rose brossé/or rose/prune
Brushed pink gold/pink gold/plum
Oro rosa cepillado/oro rosa/ciruela
Roségold gebürstet/roségold/pflaume
Ouro rosa escovado/ouro rosa/roxo

① F984

MINIMA-11C / DP2

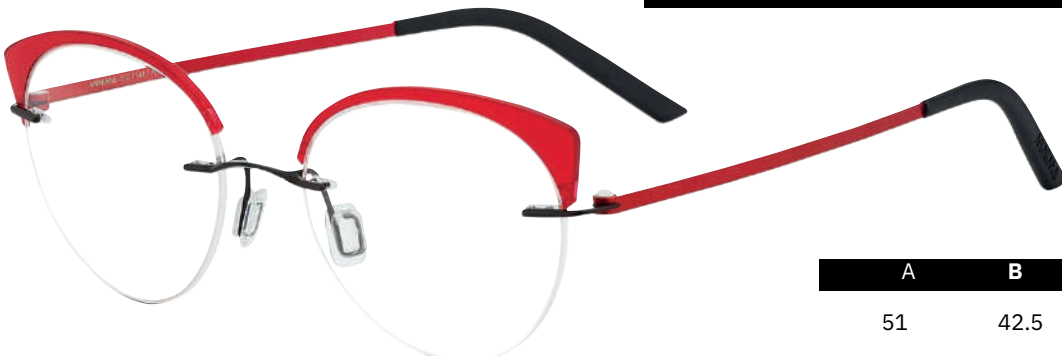

A	B	ED
51	42.5	53.4



6005

Or brossé/or/écaille
Gold brushed/gold/tortoise
Oro cepillado/oro/carey
Gold gebürstet/gold/schildpatt
Ouro escovado/ouro/escama



6006

Rouge/noir/rouge
Red/black/red
Rojo/negro/rojo
Rot/schwarz/rot
Vermelho/preto/vermelho

PONTS EUROPE

European bridge / Puente europeo
Europäischer Nasensteg / Ponte Europa

XS
 S

PONTS ASIE

Asian bridge / Puente asiático
Asiatischer Nasensteg / Ponte Àsia

XS
 S

LONGUEUR DE BRANCHES

Temple length / Largo de varillas
Bugellänge / Tamanho das hastas 144 mm

① F981

MINIMA-11C / DP3



A	B	ED
49	46	51.7

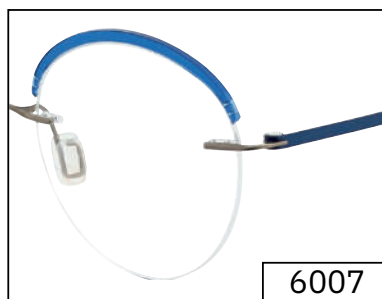

Bleu nuit/titane poli/bleu nuit
 Night blue/titanium polished/night bleu
 Azul oscuro/titanio pulido/azul oscuro
 Nachtblau/titan poliert/nachtblau
 Azul escuro/titanio polido/azul escuro

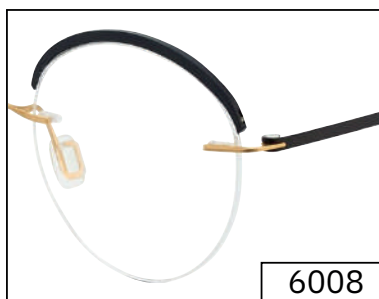

Noir brillant/or/noir
 Shiny black/gold/black
 Negro brillante/oro/negro
 Schwarz glänzend/gold/schwarz
 Preto brilhante/ouro/preto

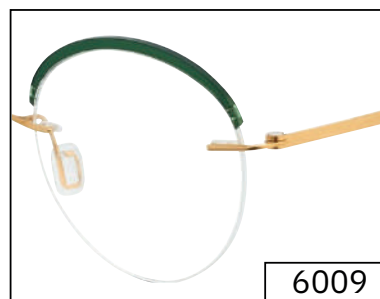

Or brossé/or/vert foncé
 Gold brushed/gold/dark green
 Oro cepillado/oro/verde oscuro
 Gold gebürstet/gold/dunkelgrün
 Ouro escovado/ouro/verde escuro

PONTS EUROPE

European bridge / Puente europeo
 Europäischer Nasensteg / Ponte Europa

XS
 S

PONTS ASIE





Asian bridge / Puente asiático
 Asiatischer Nasensteg / Ponte Àsia

XS
 S

LONGUEUR DE BRANCHES

Temple length / Largo de varillas
 Bugellänge / Tamanho das hastas 144 mm



13	 Argent – Silver – Plata Silber – Prata	19	 Noir mat – Mat black – Negro mate Schwarz matt – Preto baço	28	 Graphite – Graphite – Grafito Graphitgrau – Grafito
15	 Bronze – Bronze – Bronce Bronze – Bronze	20	 Or brillant – Shiny gold – Oro brillante Gold glänzend – Ouro brilhante		

LONGUEUR DE BRANCHES

Temple length / Largo de varillas
Bugellänge / Tamanho das hastes

149 mm



Bleu - Blue - Azul
Blau - Azul

Gris - Gray - Gris
Grau - Cinzento

Prune - Plum - Ciruela
Pflaume - Roxo

Bleu-vert - Blue green - Azul verdoso
Petrol - Azul verdeado

Noir - Black - Negro
Schwarz - Preto

LONGUEUR DE BRANCHES

Temple length / Largo de varillas
Bugellänge / Tamanho das hastes

149 mm

MINIMA POCKET



LONGUEUR DE BRANCHES

Temple length / Largo de varillas
Bugellänge / Tamanho das hastas

143 mm

34		Argent brossé – Silver brushed – Plata cepillado Silber gebürstet – Prata escovada	13T		Argent brillant – Shiny silver – Plata brillante Silber glänzend – Prata brilhante	18U		Noir brillant – Shiny black – Negro brillante Schwarz glänzend – Preto brilhante
36		Bronze brossé – Bronze brushed Bronce cepillado – Bronze gebürstet Bronze escovada	18T		Noir brillant – Shiny black – Negro brillante Schwarz glänzend – Preto brilhante	20U		Or brillant – Shiny gold – Oro brillante Gold glänzend – Ouro brilhante
037		Or rose brossé – Pink gold brushed Oro rosa cepillado – Roségold gebürstet Ouro rosa escovado	20T		Or brillant – Shiny gold – Oro brillante Gold glänzend – Ouro brilhante			
			13U		Argent brillant – Shiny silver – Plata brillante Silber glänzend – Prata brilhante			

FORMES VERRES - SHAPE LENSES

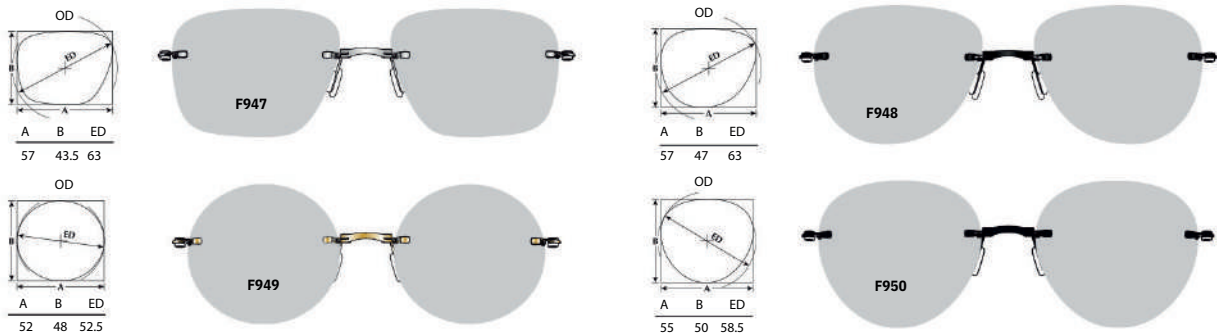

COLORIS VERRES - COLOR LENSES

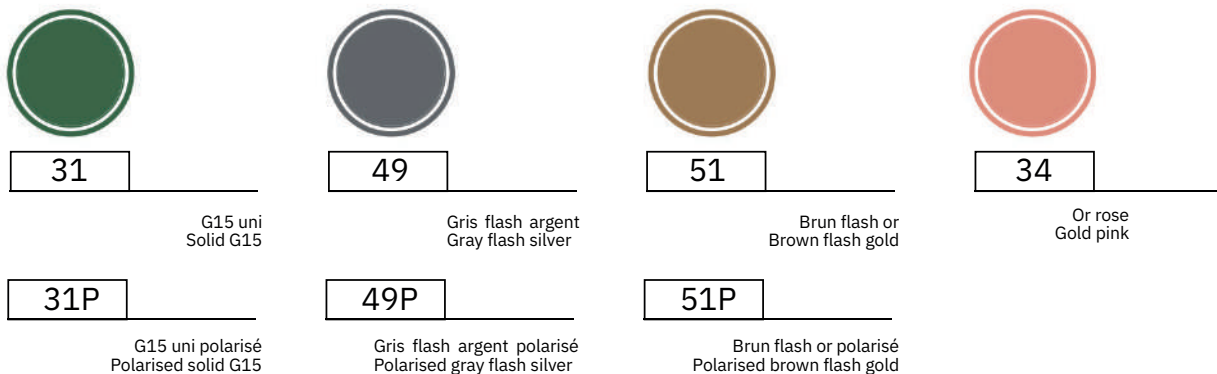



COLLECTION "INTERCHANGEABLES"

M-5/5C PLUS / T1

Métal
Metal
Metal
Metall
Metal



M-5C PLUS

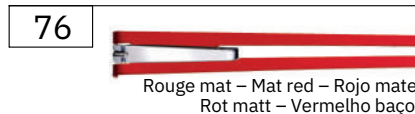
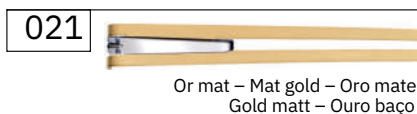
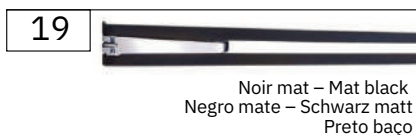

M-5/5C PLUS / T2

Plastique
Plastic
Plástico
Plastik
Plástico



M-5C PLUS



LONGUEUR DE BRANCHES

Temple length / Largo de varillas
Bugellänge / Tamanho das hastas

144 mm

COULEURS DE FACE

00 Titane poli – Polished titanium – Titanio pulido
Titan poliert – Titanio polido
18 Noir brillant – Shiny black – Negro brillante
Schwarz glänzend – Preto brilhante
20 Or brillant – Shiny gold – Oro brillante
Gold glänzend – Ouro brilhante

Front colors / Cores frente / Farbe der front / Cores frente

32 Gris foncé mat – Mat dark gray – Gris oscuro mate
Dunkelgrau matt – Cinzeno escuro baço
28 Graphite – Graphite – Grafito – Graphitgrau – Grafito
022 Or rose – Pink gold – Oro rosa – Roségold
Ouro rosa

① F876 / Col. 096

M-5/5C PLUS / T3



M-5 PLUS

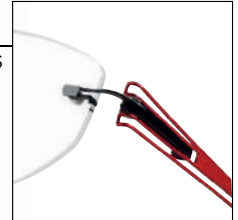

Métal
Metal
Metal
Metall
Metal

18



Noir brillant – Shiny black – Negro brillante
Schwarz glänzend – Preto brilhante

21



Or mat – Mat gold – Oro mate
Gold matt – Ouro baço

025



Or rose mat – Mat pink gold
Oro rosa mate – Roségold matt
Ouro rosa baço

69



Bleu nacré mat – Mat pearly blue
Azul nacarado mate – Perblau matt
Azul nácar baço

76



Rouge – Red – Rojo
Rot – Vermelho

096



Aubergine mat – Mat dark purple
Violeta oscuro mate – Aubergine matt
Berinjela baço

111



Noir/blanc – Black/white – Negro/blanco
Schwarz/weiß – Preto/branco

113



Noir brillant/gris mat – Shiny black/mat gray
Negro brilhante/gris mate – Schwarz glänzend/
grau matt – Preto brilhante/cinzeiro baço

① F876 / Col. 305

M-5/5C PLUS / T4



M-5C PLUS

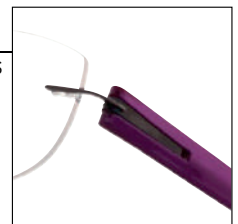

Plastique
Plastic
Plástico
Plastik
Plástico

305



Rouge brillant – Shiny red – Rojo brillante
Rot glänzend – Vermelho brilhante

308



Fuchsia brillant – Shiny fuchsia – Fucsia brillante
Fuchsia glänzend – Fucsia brilhante

310



Vieux rose brillant – Shiny pale rose
Rosa viejo brillante – Altrosa glänzend
Rosa velho brilhante

306



Blanc brillant – Shiny white – Blanco brillante
Weiß glänzend – Branco brilhante

307



Noir brillant – Shiny black – Negro brillante
Schwarz glänzend – Preto brilhante

320



Bleu – Blue – Azul – Blau – Azul

LONGUEUR DE BRANCHES

Temple length / Largo de varillas
Bugellänge / Tamanho das hastas

134 mm

COULEURS DE FACE

00 Titane poli – Polished titanium – Titanio pulido
Titan poliert – Titanio polido
18 Noir brillant – Shiny black – Negro brillante
Schwarz glänzend – Preto brilhante
20 Or brillant – Shiny gold – Oro brillante
Gold glänzend – Ouro brilhante

Front colors / Cores frente / Farbe der front / Cores frente

32 Gris foncé mat – Mat dark gray – Gris oscuro mate
Dunkelgrau matt – Cinzeiro escuro baço
28 Graphite – Graphite – Grafito – Graphitgrau – Grafito
022 Or rose – Pink gold – Oro rosa – Roségold
Ouro rosa

Plastique
Plastic
Plástico
Plastik
Plástico

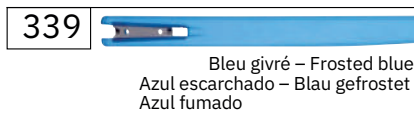
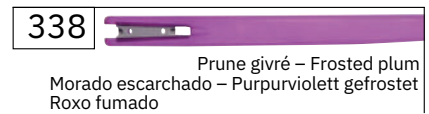
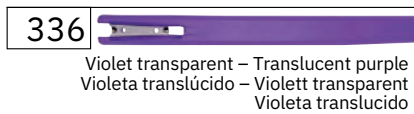
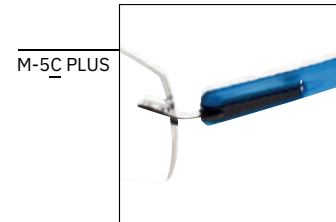

LONGUEUR DE BRANCHES

Temple length / Largo de varillas
Bugellänge / Tamanho das hastes

148 mm

COULEURS DE FACE

00 Titane poli – Polished titanium – Titanio pulido
Titan poliert – Titanio polido
18 Noir brillant – Shiny black – Negro brillante
Schwarz glänzend – Preto brilhante
20 Or brillant – Shiny gold – Oro brillante
Gold glänzend – Ouro brilhante

Front colors / Cores frente / Farbe der front / Cores frente

32 Gris foncé mat – Mat dark gray – Gris oscuro mate
Dunkelgrau matt – Cinzento escuro baço
28 Graphite – Graphite – Grafito – Graphitgrau – Grafito
022 Or rose – Pink gold – Oro rosa – Roségold
Ouro rosa

Métal
Metal
Metal
Metall
Metal



M-5 PLUS

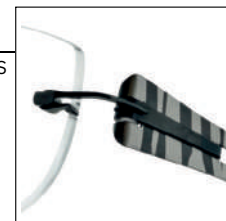

144



Zébre•noir brillant/gris mat
Shiny black/mat gray•zebra Cebra•negro
brillante/gris mate Zebra•schwarz glänzend/grau
matt Zebra•preto brilhante/cinza baço

146



Pois•marron mat/argent brillant
Mat brown/shiny silver•polka dot
Lunares•marron mate/plata brillante
Gepunktet•braun matt/silber glänzend
Bolinhas•castanho baço/prata brilhante

147



Pois•blanc mat/argent brillant
Mat white/shiny silver•polka dot Lunares•blanco
mate/plata brillante Gepunktet•weiß matt/silber
glänzend Bolinhas•branco baço/prata brilhante

148



Pois•parme mat/argent brillant
Mat violet/shiny silver•polka dot Lunares•malva
mate/plata brillante Gepunktet•parma
matt/silber glänzend Bolinhas•parma baço/prata
brilhante

149

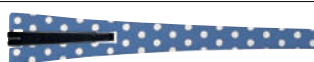

Pois•bleu mat/argent brillant
Mat blue/shiny silver•polka dot Lunares•azul
mate/plata brillante Gepunktet•blau matt/silber
glänzend Bolinhas•azul baço/prata brilhante

152



Ecaille•or rose brillant Tortoise•shiny pink gold
Carey•oro rosa brillante Schildpatt•roségold
glänzend Escama•ouro rosa brilhante

153



Ecaille•noir brillant Tortoise•shiny black
Carey•negro brillante Schildpatt•schwarz
glänzend Escama•preto brilhante

154



Ecaille•argent brillant Tortoise•shiny silver
Carey•plata brillante Schildpatt•silber glänzend
Escama•prata brilhante

LONGUEUR DE BRANCHES

Temple length / Largo de varillas
Bugellänge / Tamanho das hastes

134 mm

COULEURS DE FACE

00 Titane poli – Polished titanium – Titanio pulido
Titan poliert – Titanio pulido
18 Noir brillant – Shiny black – Negro brillante
Schwarz glänzend – Preto brilhante
20 Or brillant – Shiny gold – Oro brillante
Gold glänzend – Ouro brilhante

Front colors / Cores frente / Farbe der front / Cores frente

32 Gris foncé mat – Mat dark gray – Gris oscuro mate
Dunkelgrau matt – Cinzento escuro baço
28 Graphite – Graphite – Grafito – Graphitgrau – Grafito
022 Or rose – Pink gold – Oro rosa – Roségold
Ouro rosa

① F876

M-5/5C PLUS / T11

Métal
Metal
Metal
Metall
Metal



022  Or rose brillant
Shiny rose gold – Oro rosa brillante
Roségold glänzend – Ouro rosa brilhante

13  Argent brillant
Shiny silver – Plata brillante
Silber glänzend – Prata brilhante

20  Or brillant
Shiny gold – Oro brillante
Gold glänzend – Ouro brilhante

LONGUEUR DE BRANCHES

Temple length / Largo de varillas
Bugellänge / Tamanho das hastas

134 mm

M-5/5C PLUS / T12

① F883 / Col. 13

Métal
Metal
Metal
Metall
Metal



13  Argent brillant – Shiny silver – Plata brillante
Silber glänzend – Prata brilhante

20  Or brillant – Shiny gold – Oro brillante
Gold glänzend – Ouro brilhante

343  Gun brillant – Shiny gun – Gun brillante
Gun glänzend – Gun brilhante

LONGUEUR DE BRANCHES

Temple length / Largo de varillas
Bugellänge / Tamanho das hastas

144 mm

COULEURS DE FACE

00 Titane poli – Polished titanium – Titanio pulido
Titan poliert – Titanio polido
18 Noir brillant – Shiny black – Negro brillante
Schwarz glänzend – Preto brilhante
20 Or brillant – Shiny gold – Oro brillante
Gold glänzend – Ouro brilhante

Front colors / Cores frente / Farbe der front / Cores frente

32 Gris foncé mat – Mat dark gray – Gris oscuro mate
Dunkelgrau matt – Cinzento escuro baço
28 Graphite – Graphite – Grafito – Graphitgrau – Grafito
022 Or rose – Pink gold – Oro rosa – Roségold
Ouro rosa



COLLECTION "TENDANCES"

MINIMA-66/66C

① F989 / Col. R91



M-66

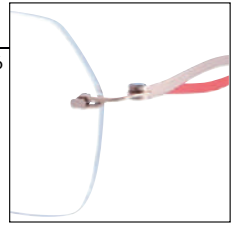

R91

Or rose brillant/corail
Shiny pink gold/coral
Oro rosa brillante/coral
Roségold glänzend/koralle
Ouro rosa brilhante/coral

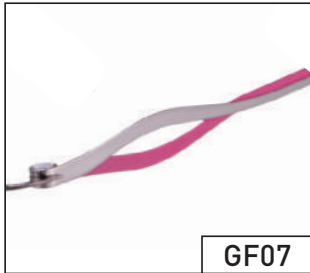

GF07

Gris foncé brillant/fuchsia
Shiny dark gray/fuchsia
Gris oscuro brillante/fucsia
Dunkelgrau glänzend/fucsia
Cinzeno escuro brilhante/fucsia



N20

Noir brillant/or brillant
Shiny black/shiny gold
Negro brillante/oro brillante
Schwarz glänzend/gold glänzend
Preto brilhante/ouro brilhante

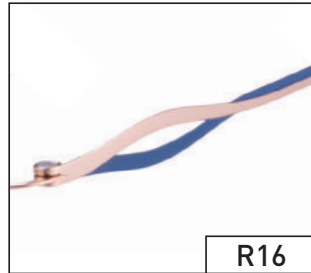

R16

Or rose brillant/marine
Shiny pink gold/navy
Oro rosa brillante/azul marino
Roségold glänzend/marine
Ouro rosa brilhante/azul marinho

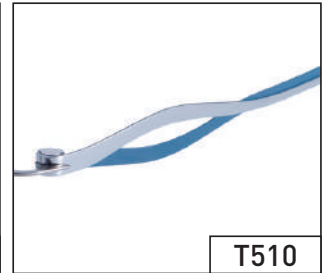

T510

Titane poli/bleu vert
Polished titanium/blue green
Titanio pulido/azul verdoso
Titan poliert/ petrol
Titanio polido/verdeado

MINIMA-67/67C

① F988 / Col. R074



M67-C

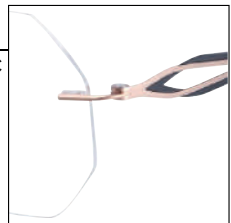

R074

Or rose brillant/noir
Shiny pink gold/black
Oro rosa brillante/negro
Roségold glänzend/schwarz
Ouro rosa brilhante/preto



O21

Or brillant/or mat
Shiny gold/mat gold
Oro brillante/oro mate
Gold glänzend/gold matt
Ouro brilhante/ouro baço



R145

Or rose brillant/prune
Shiny pink gold/plum
Oro rosa brillante/ciruela
Roségold glänzend/lila
Ouro rosa brilhante/roxo

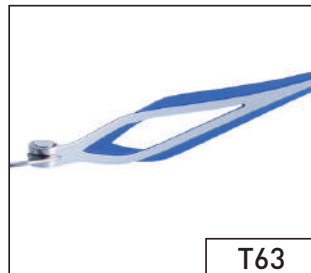

T63

Titane poli/bleu
Polished titanium/blue
Titanio pulido/azul
Titan poliert/blau
Titanio polido/azul



T134

Titane poli/vert d'eau
Polished titanium/water green
Titanio pulido/verde agua
Titan poliert/wassergrün
Titanio polido/verde água

LONGUEUR DE BRANCHES

Temple length / Largo de varillas
Bugellänge / Tamanho das hastas

139 mm

① F964 / Col. T102

MINIMA-70/70C

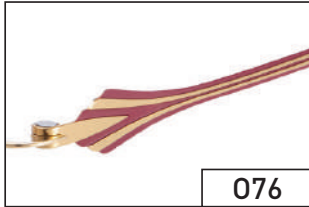
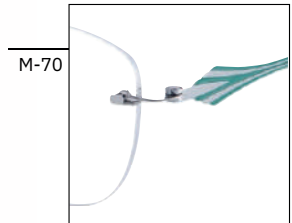

076

Or brillant/rouge
Shiny gold/red
Oro brillante/rojo
Gold glänzend/rot
Ouro brilhante/vermelho

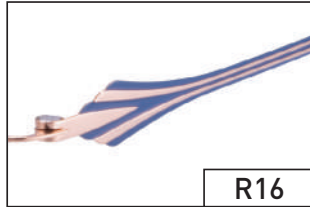

R16

Or rose brillant/marine
Shiny pink gold/navy
Oro rosa brillante/azul marino
roségold glänzend/marine
Ouro rosa brilhante/azul marinho



T102

Titane poli/vert
Polished titanium/green
Titanio pulido/verde
Titan poliert/grün
Titanio polido/verde

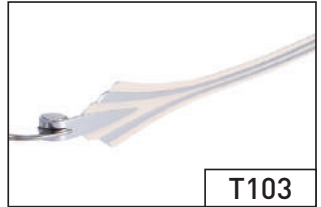

T103

Titane poli/crème
Polished titanium/cream
Titanio pulido/crema
Titan poliert/creme
Titanio polido/crema

LONGUEUR DE BRANCHES

Temple length / Largo de varillas
Bugellänge / Tamanho das hastes

139 mm

MINIMA-72/72C

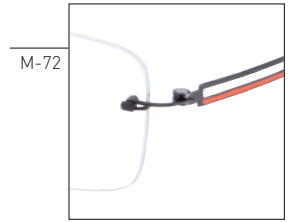

G093

Gris foncé mat/orange
Mat dark gray/orange
Gris oscuro mate/naranja
Dunkelgrau matt/orange
Cinzeno escuro baço/laranja

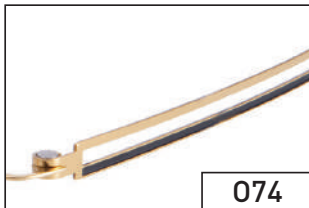

074

Or brillant/noir
Shiny gold/black
Oro brillante/negro
Gold glänzend/schwarz
Ouro brilhante/preto

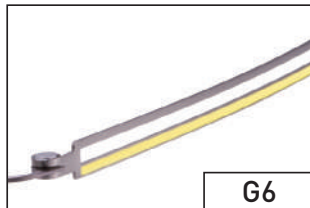

G6

Gris foncé mat/jaune
Mat dark gray/yellow
Gris oscuro mate/amarillo
Dunkelgrau matt/gelb
Cinzeno escuro baço/amarelo

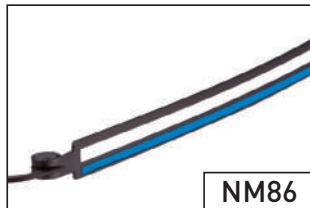

NM86

Noir mat/bleu primaire
Mat black/primary blue
Negro mate/azul primario
Schwarz matt/primärblau
Preto baço/azul primário

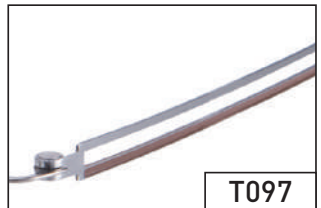

T097

Titane poli/marron
Polished titanium/brown
Titanio pulido/marron
Titan poliert/braun
Titanio polido/castanho



T63

Titane poli/bleu
Polished titanium/blue
Titanio pulido/azul
Titan poliert/blau
Titanio polido/azul

LONGUEUR DE BRANCHES

Temple length / Largo de varillas
Bugellänge / Tamanho das hastes

144 mm

① F954 / Col. T16

MINIMA-73/73C

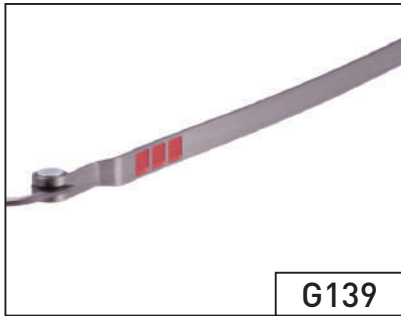

G139

Gris foncé mat/rouge
 Mat dark gray/red
 Gris oscuro mate/rojo
 Dunkelgrau matt/rot
 Cinzento escuro baço/vermelho

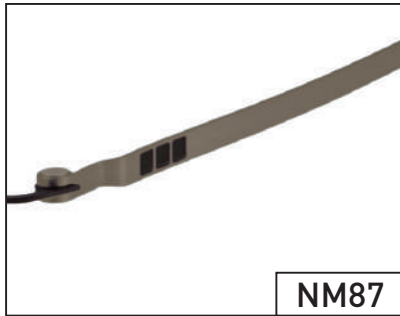

NM87

Noir mat/kaki
 Mat black/kahk
 Negro mate/caqui
 Schwarz matt/kaki
 Preto baço/caqui

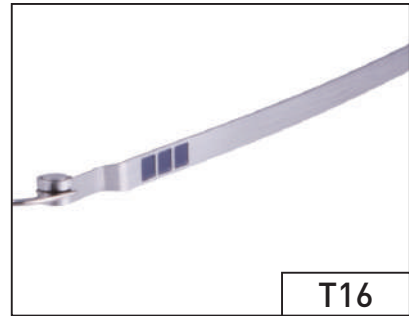

T16

Titane poli/marine
 Polished titanium/navy
 Titanio pulido/azul marino
 Titan poliert/marine
 Titanio polido/azul marinho

① F954 / Col. G6

MINIMA-74/74C

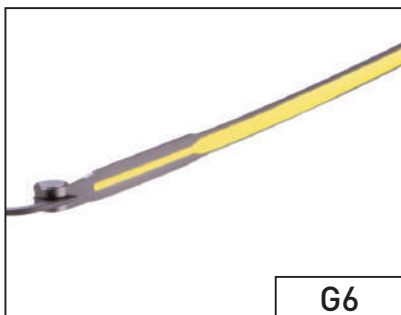

G6

Gris foncé mat/jaune
 Mat dark gray/yellow
 Gris oscuro mate/amarillo
 Dunkelgrau matt/gelb
 Cinzento escuro baço/amarelo

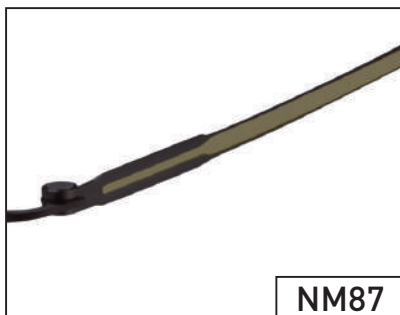

NM87

Noir mat/kaki
 Mat black/kahki
 Negro mate/caqui
 Schwarz matt/kaki
 Preto baço/caqui



T73

Titane poli/gris
 Polished titanium/silver brushed/gray
 Titanio pulido/gris
 Titan poliert/grau
 Titanio polido/cinzento

LONGUEUR DE BRANCHES

Temple length / Largo de varillas
 Bugellänge / Tamanho das hastes

144 mm

① F954 / Col. 074

MINIMA - 75 / 75C



Gris foncé mat/crème
 Mat dark gray/dark gray brushed/cream
 Gris oscuro mate/crema
 Dunkelgrau matt/creme
 Cinzento escuro baço/creme



Or brillant/noir
 Gold/Gold brushed/black
 Oro brillante/negro
 Gold glänzend/schwarz
 Ouro brilhante/preto

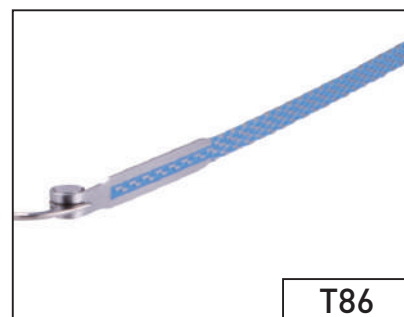

Titane poli/bleu primaire
 Polished titanium/primary blue
 Titanio pulido/azul primario
 Titan poliert/primärblau
 Titanio polido/azul primário

LONGUEUR DE BRANCHES

Temple length / Largo de varillas
 Bugellänge / Tamanho das hastes

144 mm

① F1018 / Col. R16

MINIMA - 76 / 76C



Noir brillant/indigo
 Shiny black/indigo
 Negro brillante/indigo
 Schwarz glänzend/indigoblau
 Preto brilhante/indigo



Or rose brillant/marine
 Shiny pink gold/navy
 Oro rosa brillante/azul marino
 Roségold glänzend/marine
 Ouro rosa brilhante/azul marinho



Or rose brillant/corail
 Shiny pink gold/coral
 Oro rosa brillante/coral
 Roségold glänzend/koralle
 Ouro rosa brilhante/coral

LONGUEUR DE BRANCHES

Temple length / Largo de varillas
 Bugellänge / Tamanho das hastes

139 mm

① F980 / Col. GF1

MINIMA-77/77C



M-77

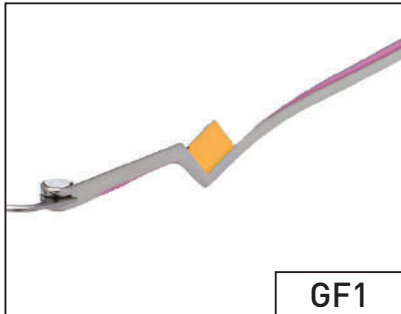

GF1

Gris foncé brillant/prune-jaune
 Shiny dark gray/plum-yellow
 Gris oscuro brillante/cirueta-amarilla
 Dunkelgrau glänzend/lila-gelb
 Cinzento escuro brilhante/roxo-amarelo



N136

Noir brillant/fuchsia-orange
 Shiny black/fuchsia-orange
 Negro brillante/fuchsia-naranja
 Schwarz glänzend/fuchsia-orange
 Preto brilhante/fuchsia-laranja

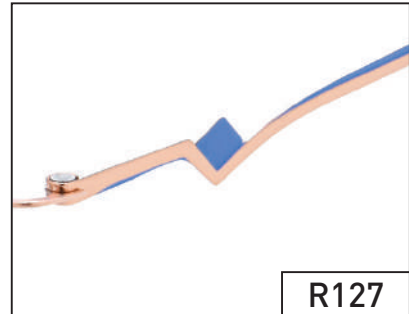

R127

Or rose brillant/bleu lavande
 Shiny pink gold/blue lavender
 Oro rosa brillante/azul lavanda
 Roségold glänzend/lavendelbleu
 Ouro rosa brilhante/alfazema azul

① F998 / Col. R145

MINIMA-78/78C



M-78C



GF2

Gris foncé brillant/aquamarine
 Shiny dark gray/aquamarine
 Gris oscuro brillante/aguamarina
 Dunkelgrau glänzend/aquamarin
 Cinzento escuro brilhante/água-marinha



R145

Or rose brillant/prune
 Shiny pink gold/plum
 Oro rosa brillante/ ciruela
 Roségold glänzend/lila
 Ouro rosa brilhante/roxo

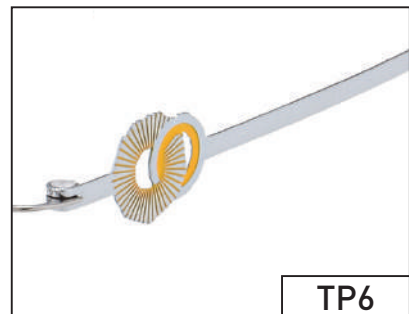

TP6

Titane poli/jaune
 Polished titanium/yellow
 Titanio pulido/amarillo
 Titan poliert/gelb
 Titanio polido/amarelo

LONGUEUR DE BRANCHES

Temple length / Largo de varillas
 Bugellänge / Tamanho das hastas

139 mm

① F987 / Col. GF3

MINIMA-79/79C



Gris foncé brillant/vert flash
Shiny dark gray/bright green
Gris oscuro brillante/verde vivo
Dunkelgrau glänzend/apfelgrün
Cinzeno escuro brilhante/verde vivo



Or rose brillant/crème
Shiny pink gold/cream
Oro rosa brillante/crema
Roségold glänzend/creme
Ouro rosa brilhante/creme



Titane poli/bleu lavande
Polished titanium/blue lavender
Titanio pulido/azul lavanda
Titan poliert/lavendelbleu
Titanio polido/alfazema azul

LONGUEUR DE BRANCHES

Temple length / Largo de varillas
Bugellänge / Tamanho das hastes

139 mm

MINIMA-510/510C



- Titane poli – Polished titanium
- Titânico polido – Titan poliert
- Oro brillante – Shiny gold
- Ouro brilhante – Gold glänzend
- Or rose – Pink gold
- Ouro rosa – Rosegold
- Noir brillant – Shiny black
- Preto brilhante – Schwarz glänzend
- Graphite – Graphite
- Grafito – Graphitgrau
- Gris foncé – Dark gray
- Cinza escuro – Dunkelgrau

COULEUR DE BRANCHES

- Blanc – White – Blanco – Weiß – Branco
- Noir – Black – Negro – Schwarz – Preto
- Savane – Savannah – Sabana – Savanne Savana
- Gris foncé – Dark gray – Gris oscuro Dunkelgrau – Cinzento escuro
- Taupe – Brown gray – Marrón gris Graubraun – Bege cinzento
- Jaune – Yellow – Amarillo – Gelb – Amarelo
- Marron – Brown – Marrón – Braun Castanho
- Abricot – Apricot – Albaricoque – Apricot Abricot
- Fuchsia – Fuchsia – Fucsia – Fuchsia Fuchsia
- Rose poudré – Powder pink – Rosa pálido Altrosa – Rosado claro
- Rouge – Red – Rojo – Rot – Vermelho
- Aubergine – Dark purple – Violeta oscuro Aubergine – Berinjela
- Bleu nuit – Night blue – Azul oscuro Nachtblau – Azul escuro
- Bleu canard – Peacock blue – Azul verdoso Petrol – Verdeado

COULEUR DE FACE

TP1	O1	R1	N1	GP1	G1
TP2	O2	R2	N2	GP2	G2
TP3	O3	R3	N3	GP3	G3
TP4	O4	R4	N4	GP4	G4
TP5	O5	R5	N5	GP5	G5
TP6	O6	R6	N6	GP6	G6
TP7	O7	R7	N7	GP7	G7
TP8	O8	R8	N8	GP8	G8
TP9	O9	R9	N9	GP9	G9
TP10	O10	R10	N10	GP10	G10
TP11	O11	R11	N11	GP10	G11
TP12	O12	R12	N12	GP12	G12
TP13	O13	R13	N13	GP13	G13
TP15	O15	R15	N15	GP15	G15



TP17

Titane poli/rouge foncé
Polished titanium/dark red
Titanio pulido/rojo oscuro
Titan poliert/dunkel rot
Titanio polido/vermelho escuro

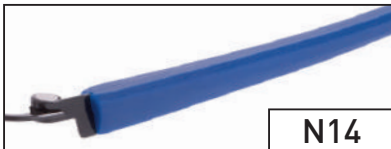

N14

Noir brillant/bleu roi
Shiny black/blue
Negro brillante/azul
Schwarz glänzend/königsblau
Preto brilhante/azul real



N17

Noir brillant/rouge foncé
Shiny black/dark red
Negro brillante/rojo oscuro
Schwarz glänzend/dunkel rot
Preto brilhante/vermelho escuro



NM11

Noir mat/rouge
Matt black/red
Negro mate/rojo
Schwarz matt/rot
Preto baço/vermelho



NM16

Noir mat/orange
Matt black/orange
Negro mate/naranja
Schwarz matt/orange
Preto baço/laranja



NM18

Noir mat/kaki
Matt black/khaki
Negro mate/caqui
Schwarz matt/kaki
Preto baço/caqui



O2

Or brillant/noir
Shiny gold/black
Oro brillante/negro
Gold glänzend/schwarz
Ouro brilhante/preto

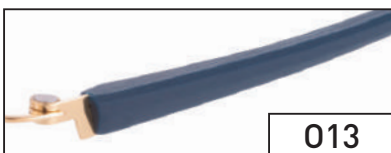

O13

Or brillant/bleu nuit
Shiny gold/night blue
Oro brillante/azul oscuro
Gold glänzend/nachtblau
Ouro brilhante/azul escuro



TP2

Titane poli/noir
Polished titanium/black
Titanio pulido/negro
Titan poliert/schwarz
Titanio polido/preto



TP5

Titane poli/taupe
Polished titanium/brown gray
Titanio pulido/marron
Titan poliert/grau-braun
Titanio polido/castanho claro



TP6

Titane poli/jaune
Polished titanium/yellow
Titanio pulido/amarillo
Titan poliert/Gelb
Titanio polido/amarelo



TP11

Titane poli/rouge
Polished titanium/red
Titanio pulido/rojo
Titan poliert/rot
Titanio polido/vermelho



TP13

Titane poli/bleu nuit
Polished titanium/night blue
Titanio pulido/azul oscuro
Titan poliert/nachtblau
Titanio polido/azul escuro

LONGUEUR DE BRANCHES

Temple length / Largo de varillas
Bugellänge / Tamanho das hastas

144 mm

MINIMA-511/511C



TP14

Titane poli/bleu roi
Polished titanium/blue
Titanio pulido/azul
Titan poliert/königsblau
Titanio polido/azul real



TP16

Titane poli/orange
Polished titanium/orange
Titanio pulido/naranja
Titan poliert/orange
Titanio polido/laranja



TP18

Titane poli/kaki
Polished titanium/kahki
Titanio pulido/caqui
Titan poliert/kaki
Titanio polido/caqui

① F969 / Col. NMC4



NMC3

Noir mat/carbone-kaki
Matt black/carbon-kahki
Negro mate/carbón-caqui
Schwarz matt/carbon-kaki
Preto baço/carbono-caqui



NMC4

Noir mat/carbone-bleu vif
Matt black/carbon-bright blue
Negro mate/carbón-azul vivo
Schwarz matt/carbon-leuchtend blau
Preto baço/carbono-azul vivo



TPC1

Titane poli/carbone-orange
Polished titanium/carbon-orange
Titanio pulido/carbón-naranja
Titan poliert/carbon-orange
Titanio polido/carbono-laranja



TPC2

Titane poli/carbone-rouge
Polished titanium/carbon-red
Titanio pulido/carbón-rojo
Titan poliert/carbon-rot
Titanio polido/carbono-vermelho



TPC5

Titane poli/carbone-gris clair
Polished titanium/carbon-light gray
Titanio pulido/carbón-gris claro
Titan poliert/carbon-hell grau
Titanio polido/carbono-conzento claro

LONGUEUR DE BRANCHES

Temple length / Largo de varillas
Bugellänge / Tamanho das hastas

144 mm

TENDANCES
FASHION
TENDENCIA
TENDENZ
ACTUAL

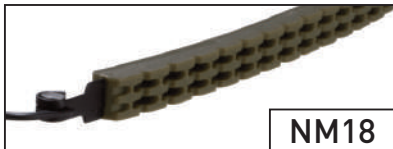

NM18

Noir mat/kaki
Matt black/kahki
Negro mate/caqui
Schwarz matt/kaki
Preto baço/caqui



02

Or brillant/noir
Shiny gold/black
Oro brillante/negro
Gold glänzend/schwarz
Ouro brilhante/preto

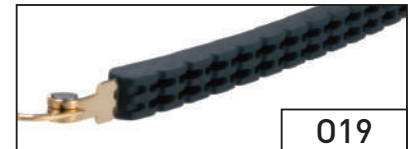

019

Or brillant/bleu pétrole
Shiny gold/petrol blue
Oro brillante/azul petróleo
Gold glänzend/petrolblau
Ouro brilhante/azul petróleo



TP2

Titane poli/noir
Polished titanium/black
Titanio pulido/negro
Titan poliert/schwarz
Titânio polido/preto



TP18

Titane poli/kaki
Polished titanium/kahki
Titanio pulido/caqui
Titan poliert/kaki
Titânio polido/caqui



TP19

Titane poli/bleu pétrole
Polished titanium/petrol blue
Titanio pulido/azul petróleo
Titan poliert/petrolblau
Titânio polido/azul petróleo

LONGUEUR DE BRANCHES

Temple length / Largo de varillas
Bugellänge / Tamanho das hastas

144 mm

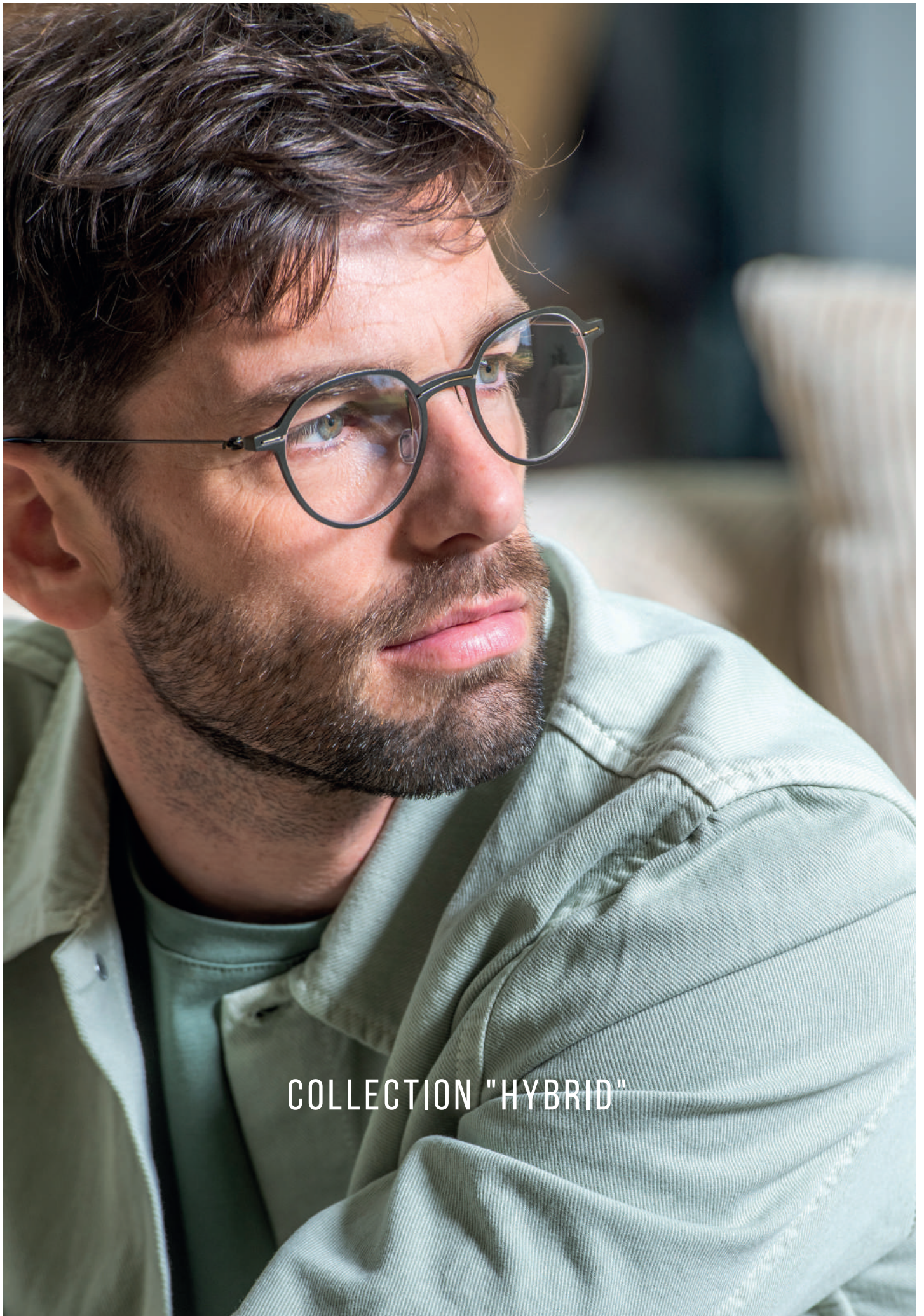

COLLECTION "HYBRID"

HYBRID-1 / C23



A	B	ED	N
49	42.5	52	19
49	42.5	52	21



600A

Ecaïlle bleu foncé brillant/noir brillant/noir
Shiny dark blue tortoise/shiny black/black
Carey azul oscuro brillante/negro brillante/negro
Schildpatt dunkelblau glänzend/schwarz glänzend/
schwarz
Escama azul oscuro brilhante/preto brilhante/
preto



601A

Brun marbré brillant/titane poli/cristal
Shiny brown marble/polished titanium/crystal
Marrón jaspeado brillante/titanio pulido/cristal
Braun marmoriert glänzend/titan poliert/kristall
Castanho marmorizado brilhante/titanio polido/
cristal



602A

Noir brillant/or brillant/noir
Shiny black/shiny gold/black
Negro brillante/oro brillante/negro
Schwarz glänzend/gold glänzend/schwarz
Preto brilhante/ouro brilhante/preto



622A

Noir-écaïlle beige brillant/noir brillant/noir
Black-shiny tortoise beige/shiny black/black
Negro-carey beige brillante/negro brillante/ negro
Schwarz-schildpatt beige glänzend/
schwarz glänzend/schwarz
Preto-escama bege brilhante/preto brilhante/
preto



623A

Bordeaux fumé brillant/titane poli/cristal
Shiny burgundy smoke/polished titanium/
crystal
Rojo-violáceo ahumado brillante/titanio pulido/
cristal
Weinrot rauchte glänzend/titan poliert/kristall
Bordeaux fumado brilhante/titanio polido/
cristal

PONTS EUROPE

European bridge / Puente europeo
Europäischer Nasensteg / Ponte Europa

✓ XS
✓ S

PONTS ASIE

Asian bridge / Puente asiático
Asiatischer Nasensteg / Ponte Ásia

✓ XS
✓ S

LONGUEUR DE BRANCHES

Temple length / Largo de varillas
Bugellänge / Tamanho das hastes 148 mm

HYBRID-1 / C24



A	B	ED	N
52	41	59	19
52	41	59	21



602A

Noir brillant/or brillant/noir
 Shiny black/shiny gold/black
 Negro brillante/oro brillante/negro
 Schwarz glänzend/gold glänzend/schwarz
 Preto brilhante/ouro brilhante/preto
 Noir brillant/titane poli/noir



602B

Shiny black/polished titanium/black
 Negro brillante/titanio pulido/negro
 Schwarz glänzend/titan poliert/schwarz
 Preto brilhante/titanio polido/preto

HYBRID-1 / C25



A	B	ED	N
48	38	50	19
48	38	50	21



606A

Ecaïlle bleu brillant/noir brillant/noir
 Shiny blue tortoise/shiny black/black
 Carey azul brilhante/negro brilhante/negro
 Schildpatt blau glänzend/schwarz glänzend/
 schwarz
 Escama azul brilhante/preto brilhante/preto



607A

Cristal strié noir-bleu brillant/titane poli/cristal
 Shiny black-blue stripes crystal/
 polished titanium/crystal
 Cristal estriado negro-azul brillante/
 titanio pulido/cristal
 Kristall gestreift schwarz blau glänzend/
 titan poliert/kristall
 Cristal estriado preto azul brilhante/
 titanio polido/cristal



608A

Rouge marbré brillant/noir brillant/noir
 Shiny red marble/shiny black/black
 Rojo jaspeado brillante/negro brillante/negro
 Roter marmor glänzend/schwarz glänzend/
 schwarz
 Vermelho marmorizado brilhante/
 preto brilhante/preto

PONTS EUROPE
 European bridge / Puente europeo
 Europäischer Nasensteg / Ponte Europa

XS
 S

PONTS ASIE
 Asian bridge / Puente asiático
 Asiatischer Nasensteg / Ponte Ásia

XS
 S

LONGUEUR DE BRANCHES
 Temple length / Largo de varillas
 Bugellänge / Tamanho das hastes 148 mm

HYBRID-1 / C26



A	B	ED	N
48	40.5	50	19
48	40.5	50	21



602A

Noir brillant/or brillant/noir
Shiny black/shiny gold/black
Negro brillante/oro brillante/negro
Schwarz glänzend/gold glänzend/schwarz
Preto brilhante/ouro brilhante/preto



624A

Brun-bleu fumé brillant/noir brillant/noir
Shiny smoke brown-blue/shiny black/black
Marron-azul ahumado brillante/negro brillante/
negro
Rauchte braun-blau glänzend/schwarz glänzend/
schwarz
Castanho-azul fumado brilhante/preto brilhante/
preto



625A

Ecaïlle camel brillant/or brillant/cristal
Shiny brown-orange tortoise/shiny gold/crystal
Carey camel brillante/oro brillante/cristal
Schildpatt camel glänzend/gold glänzend/kristall
Escama camel brilhante/ouro brilhante/cristal

PONTS EUROPE

European bridge / Puente europeo
Europäischer Nasensteg / Ponte Europa



PONTS ASIE

Asian bridge / Puente asiático
Asiatischer Nasensteg / Ponte Ásia



LONGUEUR DE BRANCHES

Temple length / Largo de varillas
Bugellänge / Tamanho das hastas 148 mm

HYBRID-1 / C27



A	B	ED	N
47	41	49	19
47	41	49	21



Ecaïlle noir brillant/or brillant/cristal
Shiny black tortoise/shiny gold/crystal
Carey negro brillante/oro brillante/cristal
Schildpatt schwarz glänzend/
gold glänzend/kristall
Escama preto brilhante/ouro
brilhante/cristal

PONTS EUROPE

European bridge / Puente europeo
Europäischer Nasensteg / Ponte Europa

XS
 S

PONTS ASIE

Asian bridge / Puente asiático
Asiatischer Nasensteg / Ponte Asia

XS
 S

LONGUEUR DE BRANCHES

Temple length / Largo de varillas
Bugellänge / Tamanho das hastas 148 mm

HYBRID-1 / C28



A	B	ED	N
47	43.5	49.5	21
47	43.5	49.5	23



629A

Ecaïlle miel brillant/noir brillant/noir
 Shiny honey tortoise/shiny black/black
 Carey miel brillante/negro brillante/negro
 Schildpatt honig glänzend/schwarz glänzend/
 schwarz
 Escama mel brilhante/preto brilhante/preto

HYBRID-1 / C29



A	B	ED	N
48	38	52.6	19
48	38	52.6	21



632A

Ecaïlle jaune brillant/or brillant/cristal
 Shiny tortoise yellow/shiny gold/cristal
 Carey amarillo brilhante/oro brilhante/cristal
 Schildpatt gelb glänzend/gold glänzend/kristall
 Escama amarelo brilhante/ouro brilhante/cristal



634A

Noir brillant/titane poli/cristal
 Shiny black/polished titanium/cristal
 Negro brillante/titanio pulido/cristal
 Schwarz glänzend/titan poliert/kristall
 Preto brilhante/titanio polido/cristal

PONTS EUROPE

European bridge / Puente europeo
 Europäischer Nasensteg / Ponte Europa

✓ XS
 ✓ S

PONTS ASIE

Asian bridge / Puente asiático
 Asiatischer Nasensteg / Ponte Ásia

✓ XS
 ✓ S

LONGUEUR DE BRANCHES

Temple length / Largo de varillas
 Bugellänge / Tamanho das hastas 148 mm

HYBRID-1 / C32



A	B	ED	N
50	41.5	54	22
50	41.5	54	24



640A

Ecaïlle miel brillant/or brillant/cristal
Shiny tortoise honey/shiny gold/crystal
Carey miel brillante/oro brillante/cristal
Schildpatt honig glänzend/gold glänzend/kristall
Escama mel brilhante/ouro brilhante/cristal



641A

Noir brillant/titane poli/noir
Shiny black/polished titanium/black
Negro brillante/titanio pulido/negro
Schwarz glänzend/titan poliert/schwarz
Preto brilhante/titanio polido/preto



642A

Cristal brillant/titane poli/cristal
Shiny crystal/polished titanium/crystal
Cristal brillante/titanio pulido/cristal
Kristall glänzend/titan poliert/kristall
Cristal brilhante/titanio polido/cristal

HYBRID-1 / C33



A	B	ED	N
53	44	56	19
53	44	56	21



643A

Rose-noir brillant/noir brillant/noir
Shiny pink-black/shiny black/black
Rosa-negro brillante/negro brillante/negro
Pink-schwarz glänzend/schwarz glänzend/
schwarz
Rosa-preta brilhante/preto brilhante/preto



644A

Vert-violet brillant/titane poli/cristal
Shiny green-purple/polished titanium/crystal
Verde-violeta brillante/titanio pulido/cristal
Grün-lila glänzend/titan poliert/kristall
Verde-roxo brilhante/titanio polido/cristal

PONTS EUROPE

European bridge / Puente europeo
Europäischer Nasensteg / Ponte Europa

✓ XS
✓ S

PONTS ASIE

Asian bridge / Puente asiático
Asiatischer Nasensteg / Ponte Ásia

✓ XS
✓ S

LONGUEUR DE BRANCHES

Temple length / Largo de varillas
Bugellänge / Tamanho das hastes 148 mm

HYBRID-1 / C34



A	B	ED	N
48	44.5	49	20
48	44.5	49	22



646A

Ecaïlle noir brillant/noir brillant/noir
Shiny black tortoise/shiny black/black
Carey negro brillante/negro brillante/negro
Schildpatt schwarz glänzend/schwarz glänzend/
schwarz
Escama preto brilhante/preto brilhante/preto

HYBRID-1 / C35



A	B	ED	N
50	43.5	54	19
50	43.5	54	21



649A

Ecaïlle foncé brillant/noir brillant/noir
Shiny dark tortoise/shiny black/black
Carey oscuro brillante/negro brillante/negro
Schildpatt dunkel glänzend/schwarz glänzend/
schwarz
Escama escuro brilhante/preto brilhante/preto

PONTS EUROPE

European bridge / Puente europeo
Europäischer Nasensteg / Ponte Europa

XS
 S

PONTS ASIE

Asian bridge / Puente asiático
Asiatischer Nasensteg / Ponte Àsia

XS
 S

LONGUEUR DE BRANCHES

Temple length / Largo de varillas
Bugellänge / Tamanho das hastes 148 mm

HYBRID-5 / G21



A	B	ED	N
---	---	----	---

49	44	51	20
----	----	----	----



133A

Bleu foncé/titane poli/cristal
Dark blue/polished titanium/crystal
Azul oscuro/titanio pulido/cristal
Dunkelblau/titan poliert/kristall
Azul oscuro/titanio pulido/cristal



349A

Kaki/noir
Kahki/black
Caqui/negro
Kaki/schwarz
Caqui/preto



350A

Gris aluminium/marine/noir
Aluminum/navy/black
Gris aluminio/azul marino/negro
Aluminiumgrau/marine/schwarz
Cinzeno aluminio/azul marinho/preto

HYBRID-5 / G22



A	B	ED	N
---	---	----	---

52	43	56	20
----	----	----	----



03A

Bleu roi/titane poli/cristal
Blue/polished titanium/crystal
Azul oscuro/titanio pulido/cristal
Königsblau/titan poliert/kristall
Azul/titanio pulido/cristal



347A

Marron glacé/gun brillant/noir
Ice brown/shiny gun/black
Marrón hielo/gun brillante/negro
Eisbraun/gun glänzed/schwarz
Castanho-escuro/gun brilhante/preto



504D

Gris foncé/rouge/noir
Dark gray/red/black
Gris oscuro/rojo/negro
Dunkelgrau/rot/schwarz
Cinzeno escuro/vermelho/preto

PONTS EUROPE

European bridge / Puente europeo
Europäischer Nasensteg / Ponte Europa

XS
 S

PONTS ASIE

Asian bridge / Puente asiático
Asiatischer Nasensteg / Ponte Ásia

XS
 S

LONGUEUR DE BRANCHES

Temple length / Largo de varillas
Bugellänge / Tamanho das hastas 148 mm

HYBRID-5 / G23

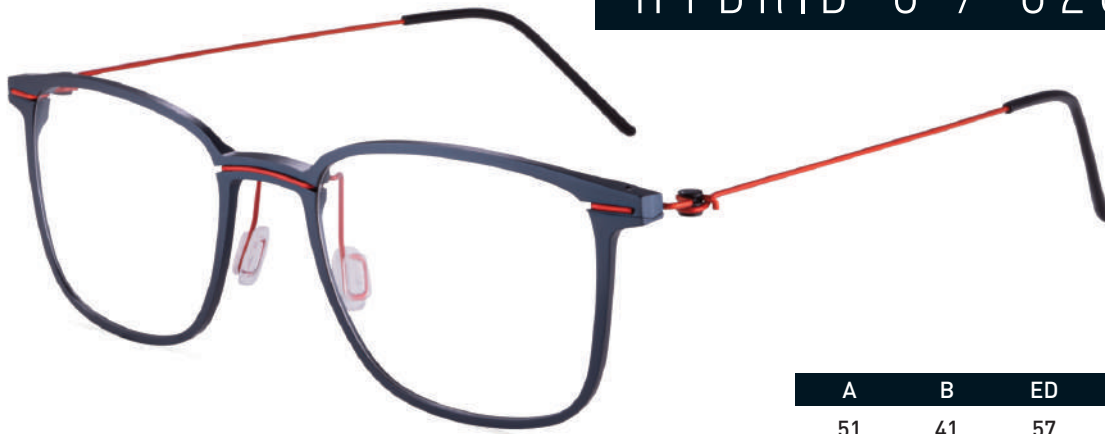

A	B	ED	N
51	41	57	20



220A

Marron/or brillant/cristal
Brown/shiny gold/crystal
Marrón/oro brillante/cristal
Braun/gold glänzend/kristall
Castanho/ouro brilhante/cristal



017B

Bleu nuit/orange/noir
Night blue/orange/black
Azul oscuro/naranja/negro
Nachtblau/orange/schwarz
Azul oscuro/laranja/preto



506C

Noir/gun brillant/noir
Black/Shiny gun/black
Negro/gun brillante/negro
Schwarz/gun glänzend/schwarz
Preto/gun brilhante/preto

HYBRID-5 / G24



A	B	ED	N
54	39	60	20



349B

Kaki/or brillant/cristal
Kahki/shiny gold/crystal
Caqui/oro brillante/cristal
Kaki/gold glänzend/kristall
Caqui/ouro brilhante/cristal



350B

Gris aluminium/noir brillant/noir
Silver/shiny black/black
Gris aluminio/negro brillante/negro
Aluminiumgrau/schwarz glänzend/schwarz
Cinzeno aluminio/preto brilhante/preto



017C

Bleu nuit/titane poli/noir
Night blue/polished titanium/black
Azul oscuro/titanio pulido/negro
Nachtblau/titan poliert/schwarz
Azul oscuro/titanio polido/preto

PONTS EUROPE

European bridge / Puente europeo
Europäischer Nasensteg / Ponte Europa

XS
 S

PONTS ASIE

Asian bridge / Puente asiático
Asiatischer Nasensteg / Ponte Ásia

XS
 S

LONGUEUR DE BRANCHES

Temple length / Largo de varillas
Bugellänge / Tamanho das hastas 148 mm

HYBRID-6 / G25



A	B	ED	N
---	---	----	---

48	43	51	19
----	----	----	----



140A

Noir/or rose brillant/noir
Black/shiny pink gold/black
Negro/oro rosa brillante/negro
Schwarz/roségold glänzend/schwarz
Preto/ouro rosa brilhante/preto



603A

Ecaïlle foncé/or brillant/cristal
Dark tortoise/shiny gold/crystal
Carey oscuro/oro brillante/cristal
Schildpatt dunkel/gold glänzend/kristall
Escama escuro/ouro brilhante/cristal



630A

Marine cristal/titane poli/cristal
Crystal navy/polished titanium/crystal
Azul marinho cristal/titanio pulido/cristal
Marine Kristall/titan poliert/kristall
Azul marinho cristal/titanio polido/cristal



577C

Ecaïlle kaki/prune/noir
Kahki tortoise/plum/black
Carey kaki/cirueta/negro
Schildpatt kaki/lila/schwarz
Escama cáqui/roxo/preto

PONTS EUROPE

European bridge / Puente europeo
Europäischer Nasensteg / Ponte Europa

XS
 S

PONTS ASIE

Asian bridge / Puente asiático
Asiatischer Nasensteg / Ponte Àsia

XS
 S

LONGUEUR DE BRANCHES

Temple length / Largo de varillas
Bugellänge / Tamanho das hastas 148 mm

HYBRID-6 / G26



A	B	ED	N
53	45	59	19



03B

Bleu roi/bleu marine/noir
Blue/navy/black
Azul oscuro/azul marinho/negro
Königsblau/marine/schwarz
Azul/azul marinho/preto



657B

Gris fumé/gun brillant/cristal
Smoke gray/shiny gun/crystal
Gris ahumado/gun brillante/cristal
Rauchgrau/gun glänzend/kristall
Cinzeno fumado/gun brilhante/cristal



569C

Magenta cristal/noir brillant/noir
Crystal magenta/shiny black/black
Magenta cristal/negro brillante/negro
Magenta Kristal/schwarz glänzend/schwarz
Magenta cristal/preto brilhante/preto

HYBRID-6 / G27



A	B	ED	N
53	45	59	19



104A

Vert olive/or brillant/cristal
Olive green/shiny gold/crystal
Verde oliva/oro brillante/cristal
Olivgrün/gold glänzend/kristall
Verde azeitona/ouro brilhante/cristal



132A

Violet fumé/or rose brillant/cristal
Smoke purple/shiny pink gold/crystal
Violeta ahumado/oro rosa brillante/cristal
Rauchviolett/roségold glänzend/kristall
Violeta fumado/ouro rosa brilhante/cristal



637C

Gris foncé/or rose brillant/cristal
Dark gray/shiny pink gold/crystal
Gris oscuro/oro rosa brillante/cristal
Dünkelgrau/roségold glänzend/kristall
Cinzeno escuro/ouro rosa brilhante/cristal

PONTS EUROPE

European bridge / Puente europeo
Europäischer Nasensteg / Ponte Europa

XS
 S

PONTS ASIE

Asian bridge / Puente asiático
Asiatischer Nasensteg / Ponte Àsia

XS
 S

LONGUEUR DE BRANCHES

Temple length / Largo de varillas
Bugellänge / Tamanho das hastes 148 mm



COLLECTION "EVO"



reddot winner 2022

EVO-1 / EN1



9920

Gris foncé brillant/or brillant
Shiny dark gray/shiny gold
Gris oscuro brillante/oro brillante
Dunkelgrau glänzend/gold glänzend
Cinzeno escuro brilhante/ouro brilhante

A	B	ED	N
50	41	54	19

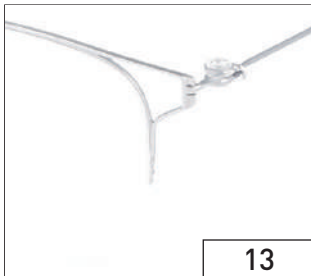

13

Argent brillant
Shiny silver
Plata brillante
Silber glänzend
Prata brilhante



52

Bleu colonial
Colonial blue
Azul colonial
Kolonialblau
Azul colonial



119

Châtaigne
Chestnut
Castaño
Kastanienbraune
Castanha



124

Vert amande
Almond green
Verde almendra
Mandelgrün
Verde amêndoa

EVO-1 / EN2



53

Rouge
Red
Rojo
Rot
Vermelho

A	B	ED	N
49	44	52	20



022

Or rose brillant
Shiny pink gold
Oro rosa brillante
Roségold glänzend
Ouro rosa brilhante



106

Rose vif
Bright pink
Rosa vivo
Hellrosa
Rosa vivo



127

Bleu lavande
Blue lavender
Azul lavanda
Lavendelblau
Alfazema azul



1913

Noir mat/argent brillant
Mat black/shiny silver
Negro mate/plata brillante
Schwarz matt/silber glänzend
Preto baço/prata brilhante

PONTS EUROPE

European bridge / Puente europeo
Europäischer Nasensteg / Ponte Europa



PONTS ASIE

Asian bridge / Puente asiático
Asiatischer Nasensteg / Ponte Àsia



LONGUEUR DE BRANCHES

Temple length / Largo de varillas
Bugellänge / Tamanho das hastas 148 mm

EVO-1 / EN3



2299

Or rose brillant/gris foncé brillant
Shiny pink gold/shiny dark gray
Oro rosa brillante/gris oscuro brillante
Roségold glänzend/dunkelgrau glänzend
Ouro rosa brilhante/cinzeno escuro
brilhante

A	B	ED	N
52	45	53	18



55

Bordeaux
Burgundy
Rojo-violáceo
Weinrot
Bordeaux



121

Indigo
Indigo
Indigo
Indigoblau
Indigo



129

Lavande
Lavender
Lavanda
Lavendel
Alfazema



1820

Noir brillant/or brillant
Shiny black/shiny gold
Negro brillante/oro brillante
Schwarz glänzend/gold glänzend
Preto brilhante/ouro brilhante

EVO-1 / EN4



1318

Argent brillant/noir brillant
Shiny silver/shiny black
Plata brillante/negro brillante
Ssilber glänzend/schwarz glänzend
Prata brilhante/preto brilhante

A	B	ED	N
53	42	59	18



58

Lilas
Lilac
Lila
Lila
Lilàs



022

Or rose brillant
Shiny pink gold
Oro rosa brillante
Roségold glänzend
Ouro rosa brilhante



128

Rouge vif
Bright red
Rojo vivo
Grell rot
Vermelho vivo



224

Bleu gris
Blue grey
Gris azulado
Blau-grau
Azul cinza

PONTS EUROPE

European bridge / Puente europeo
Europäischer Nasensteg / Ponte Europa



PONTS ASIE

Asian bridge / Puente asiático
Asiatischer Nasensteg / Ponte Ásia



LONGUEUR DE BRANCHES

Temple length / Largo de varillas
Bugellänge / Tamanho das hastas 148 mm

EVO-1 / EN5



A	B	ED	N
51	44	53	19

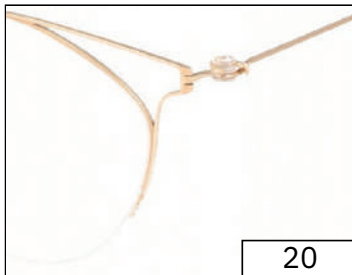

20

Or brillant
Shiny gold
Oro brillante
Gold glänzend
Ouro brilhante

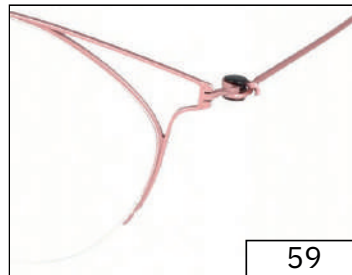

59

Rose poudré
Powder pink
Polvo Rosa
Puderrosa
Rosa escuro

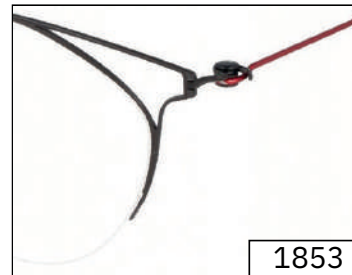

1853

Noir brillant/rouge
Shiny black/red
Negro brillante/rojo
Schwarz glänzend/rot
Preto brilhante/vermelho

EVO-1 / EN6



A	B	ED	N
48	43	50	21



13

Argent brillant
Shiny silver
Plata brillante
Silber glänzend
Prata brilhante



124

Vert amande
Almond green
Verde almendra
Mandelgrün
Verde amêndoa



1920

Noir mat/or brillant
Mat black/shiny gold
Negro mate/oro brillante
Schwarz matt/gold glänzend
Preto baço/ouro brilhante



2219

Or rose brillant/noir mat
Shiny pink gold/mat black
Oro rosa brillante/negro mate
Roségold glänzend/schwarz matt
Ouro rosa brilhante/preto baço

PONTS EUROPE

European bridge / Puente europeo
Europäischer Nasensteg / Ponte Europa



PONTS ASIE

Asian bridge / Puente asiático
Asiatischer Nasensteg / Ponte Àsia



LONGUEUR DE BRANCHES

Temple length / Largo de varillas
Bugellänge / Tamanho das hastas 148 mm

EVO-1 / EN7



A	B	ED	N
48	45	49	23

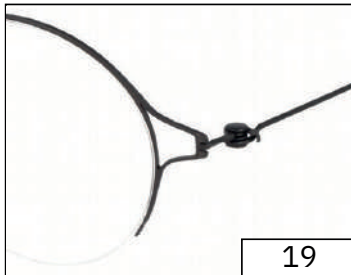

19

Noir mat
Mat black
Negro mate
Schwarz matt
Preto baço

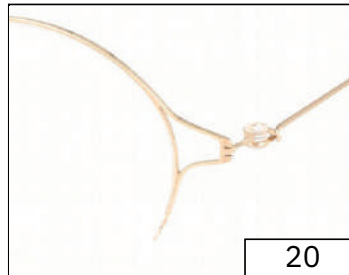

20

Or brillant
Shiny gold
Oro brillante
Gold glänzend
Ouro brilhante

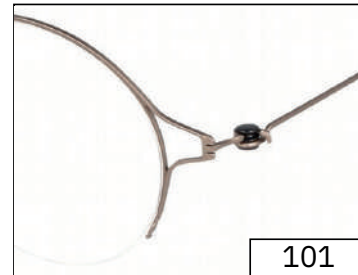

101

Brun gris
Brown mat
Marrón
Grau-braun
Castanho claro

EVO-1 / EN8



52

Bleu colonial
Colonial blue
Azul colonial
Kolonialblau
Azul colonial

A	B	ED	N
56	41	63	17



20

Or brillant
Shiny gold
Oro brillante
Gold glänzend
Ouro brilhante



99

Gris foncé brillant
Shiny dark gray
Gris oscuro brillante
Dunkelgrau glänzend
Cinzeno escuro brilhante



101

Brun gris
Brown mat
Marrón
Grau-braun
Castanho claro



105

Bleu canard
Peacock blue
Azul verdoso
Petrol
Verdeado

PONTS EUROPE

European bridge / Puente europeo
Europäischer Nasensteg / Ponte Europa



PONTS ASIE

Asian bridge / Puente asiático
Asiatischer Nasensteg / Ponte Ásia



LONGUEUR DE BRANCHES

Temple length / Largo de varillas
Bugellänge / Tamanho das hastas 148 mm

EVO-2/EN9



A	B	ED	N
54	38	58	17



130

Taupe
Brown gray
Marrón
Grau-braun
Castanho claro



224

Bleu gris
Blue grey
Gris azulado
Blau-grau
Azul cinza



1910

Noir mat/orange
Mat black/orange
Negro mate/naranja
Schwarz matt/orange
Preto baço/laranja

EVO-2/EN10



A	B	ED	N
52	42	58	19



19

Noir mat
Mat black
Negro mate
Schwarz matt
Preto baço



52

Bleu colonial
Colonial blue
Azul colonial
Kolonialblau
Azul colonial



119

Châtaigne
Chestnut
Castaño
Kastanienbraune
Castanha



124

Vert amande
Almond green
Verde almendra
Mandelgrün
Verde amêndoa

PONTS EUROPE

European bridge / Puente europeo
Europäischer Nasensteg / Ponte Europa



PONTS ASIE

Asian bridge / Puente asiático
Asiatischer Nasensteg / Ponte Asia



LONGUEUR DE BRANCHES

Temple length / Largo de varillas
Bugellänge / Tamanho das hastas 148 mm

EVO-2/EN11



A	B	ED	N
54	40,5	60	18



99

Gris foncé brillant
Shiny dark gray
Gris oscuro brillante
Dunkelgrau glänzend
Cinzeno escuro brilhante



105

Bleu canard
Peacock blue
Azul verdoso
Petrol
Verdeado



119

Châtaigne
Chestnut
Castaño
Kastanienbraune
Castanha

EVO-2/EN12



A	B	ED	N
52	47	58	18



20

Or brillant
Shiny gold
Oro brillante
Gold glänzend
Ouro brilhante



106

Rose vif
Bright pink
Rosa vivo
Hellrosa
Rosa vivo



125

Prune
Plum
Morado
Purpurviolett
Roxo



131

Bleu lagon
Blue lagoon
Azul laguna
Lagunenblau
Azul da lagoa

PONTS EUROPE

European bridge / Puente europeo
Europäischer Nasensteg / Ponte Europa



PONTS ASIE

Asian bridge / Puente asiático
Asiatischer Nasensteg / Ponte Ásia



LONGUEUR DE BRANCHES

Temple length / Largo de varillas
Bugellänge / Tamanho das hastes 148 mm

FORMES - SHAPES

FORMES / SHAPES

HYBRID-1

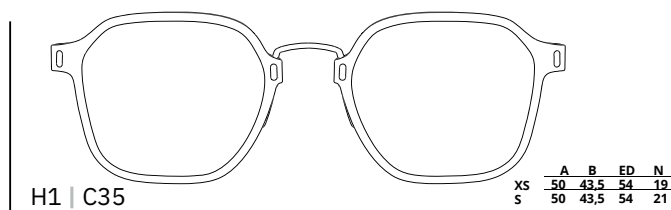
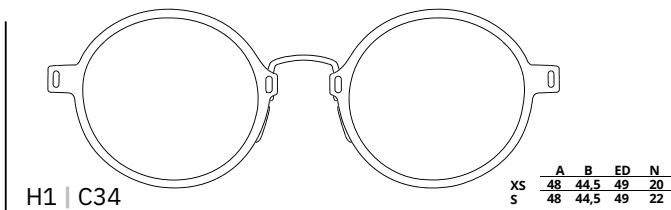
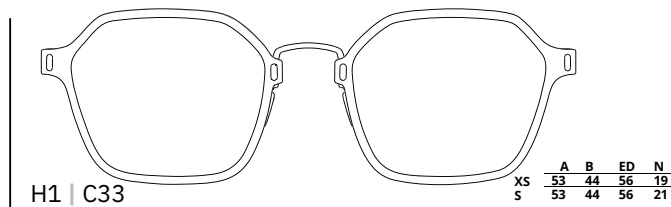
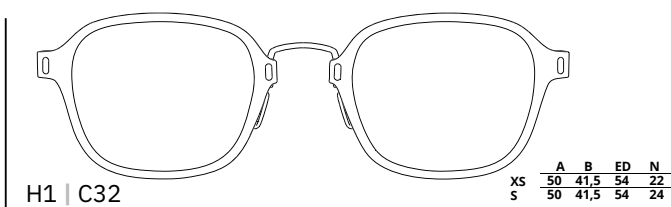
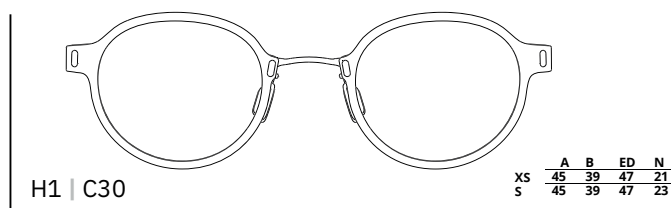
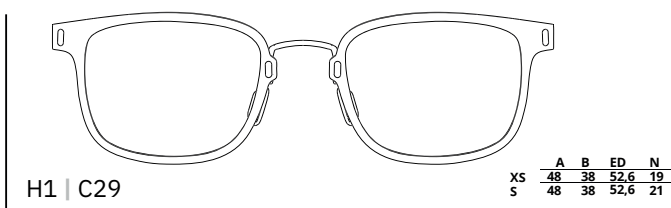
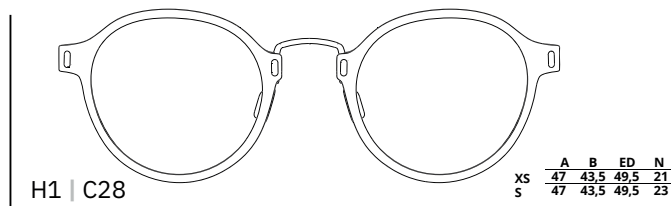
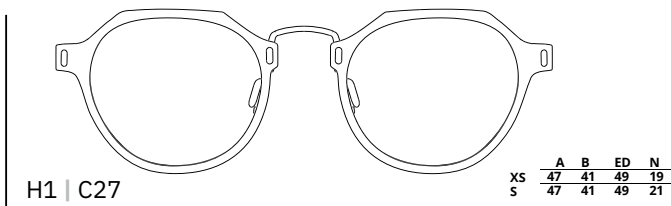
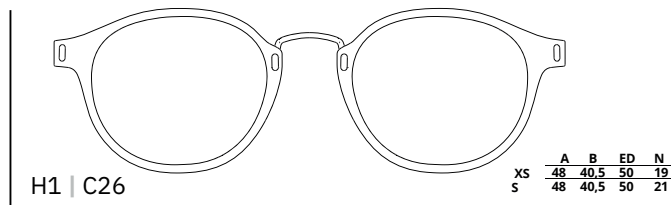
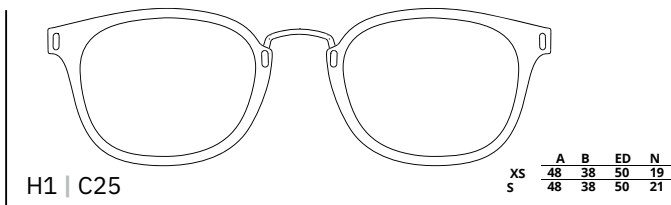
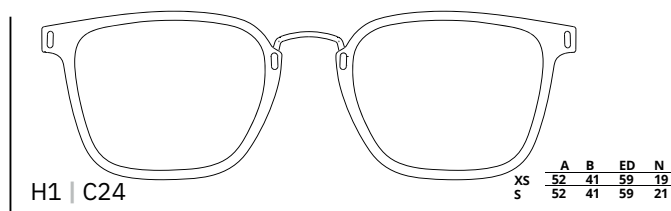
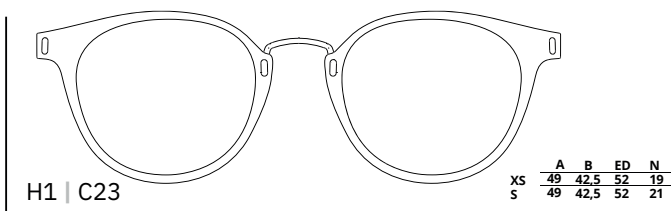

HYBRID-5

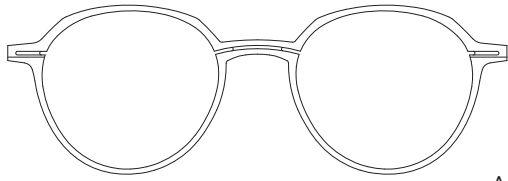

HYBRID-5 | G21

S $\frac{A}{49} \frac{B}{44} \frac{ED}{51} \frac{N}{20}$

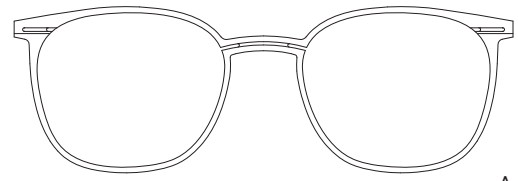

HYBRID-5 | G22

S $\frac{A}{52} \frac{B}{43} \frac{ED}{56} \frac{N}{20}$

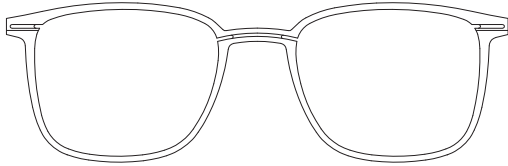

HYBRID-5 | G23

XS $\frac{A}{51} \frac{B}{41} \frac{ED}{57} \frac{N}{20}$

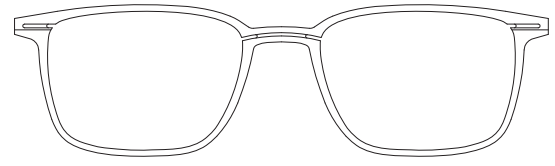

HYBRID-5 | G24

XS $\frac{A}{54} \frac{B}{39} \frac{ED}{60} \frac{N}{20}$

HYBRID-6

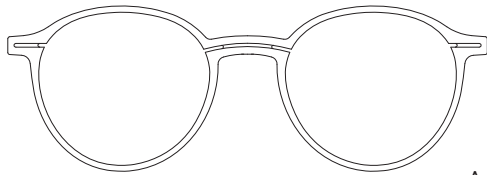

HYBRID-6 | G25

S $\frac{A}{48} \frac{B}{43} \frac{ED}{51} \frac{N}{19}$

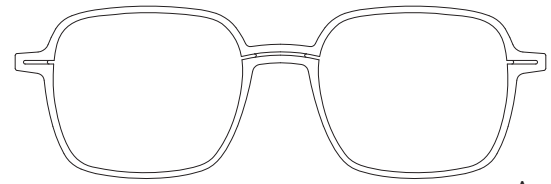

HYBRID-6 | G26

XS $\frac{A}{53} \frac{B}{45} \frac{ED}{59} \frac{N}{19}$

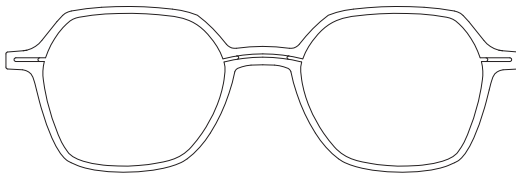

HYBRID-6 | G27

XS $\frac{A}{53} \frac{B}{45} \frac{ED}{59} \frac{N}{19}$

EVO-1

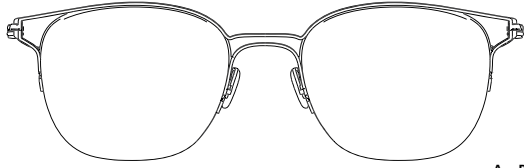

EVO-1 | EN1

$\frac{A}{50} \frac{B}{41} \frac{ED}{54} \frac{N}{19}$

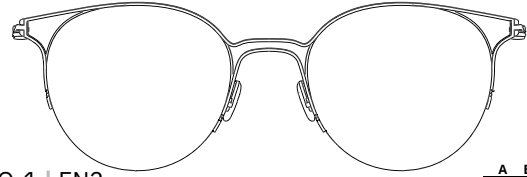

EVO-1 | EN2

$\frac{A}{49} \frac{B}{44} \frac{ED}{52} \frac{N}{20}$

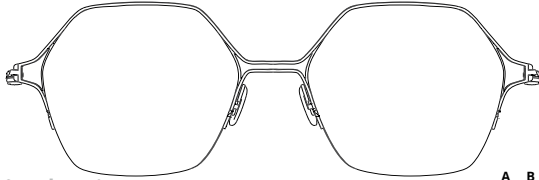

EVO-1 | EN3

$\frac{A}{52} \frac{B}{45} \frac{ED}{53} \frac{N}{18}$

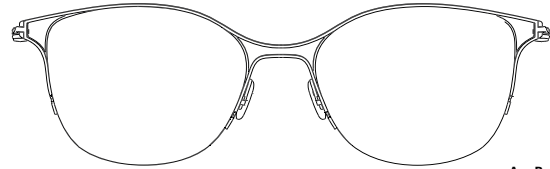

EVO-1 | EN4

$\frac{A}{51} \frac{B}{42} \frac{ED}{59} \frac{N}{18}$

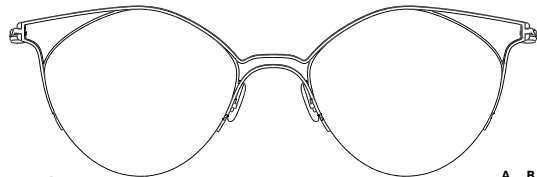

EVO-1 | EN5

$\frac{A}{51} \frac{B}{44} \frac{ED}{53} \frac{N}{19}$

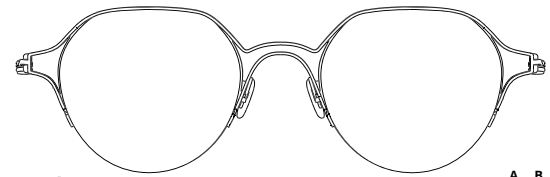

EVO-1 | EN6

$\frac{A}{48} \frac{B}{43} \frac{ED}{50} \frac{N}{21}$

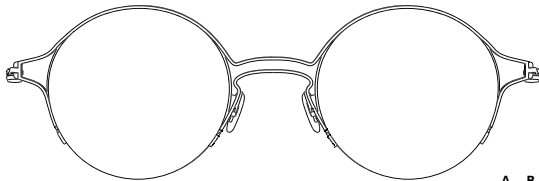

EVO-1 | EN7

$\frac{A}{48} \frac{B}{45} \frac{ED}{49} \frac{N}{23}$

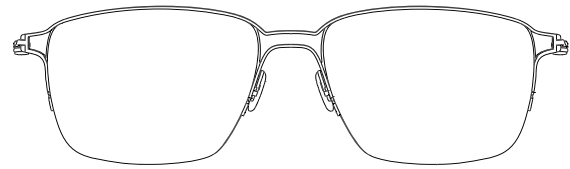

EVO-1 | EN8

$\frac{A}{56} \frac{B}{41} \frac{ED}{63} \frac{N}{17}$

EVO-2



EVO-2 | EN9

$\frac{A}{54} \frac{B}{38} \frac{ED}{58} \frac{N}{17}$



EVO-2 | EN10

$\frac{A}{52} \frac{B}{42} \frac{ED}{58} \frac{N}{19}$



EVO-2 | EN11

$\frac{A}{54} \frac{B}{40.5} \frac{ED}{60} \frac{N}{18}$



EVO-2 | EN12

$\frac{A}{52} \frac{B}{47} \frac{ED}{58} \frac{N}{18}$

PONTS - PERÇAGES

BRIDGES - DRILLINGS / PUENTES - PERFORACIONES

NASENTEG - BOHRUNG / PONTES - PERFURAÇÕES

PONTS / BRIDGES

COLLECTION VIS

SCREWS COLLECTION
COLLECCION TORNILLOS
KOLLEKTION SCHRAUBE
COLECAO COM PARAFUSOS

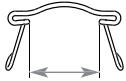

	PONTS EUROPE					PONTS ASIE				
	XS	S	M	L	XL	XS	S	M	L	XL
INVISIBLES										
M-1		15,5	17	18,5	22		15,5	17		
M-2		15,5	17	18,5	22		15,5	17		
M-3	13	15	17	19			15	17		
M-5	13	15	17	19			15	17		
M-7		15,5	17	18,5	22		15,5	17		
M-POCKET		18	20				18			
INTERCHANGEABLES										
M-5 PLUS	13	15	17	19			15	17		
TENDANCES										
M-66	13	15	17	19			15	17		
M-67	13	15	17	19			15	17		
M-70	13	15	17	19			15	17		
M-72	13	15	17	19			15	17		
M-73	13	15	17	19			15	17		
M-74	13	15	17	19			15	17		
M-75	13	15	17	19			15	17		
M-76	13	15	17	19			15	17		
M-77	13	15	17	19			15	17		
M-78	13	15	17	19			15	17		
M-79	13	15	17	19			15	17		
M-510	13	15	17	19			15	17		
M-511	13	15	17	19			15	17		
M-512	13	15	17	19			15	17		
JUNIOR										
M-JUNIOR-1/22/22G	14	16								

* En mm

COLLECTION SANS VIS

SCREWLESS COLLECTION
COLLECCION SIN TORNILLO
KOLLEKTION OHNE SCHRAUBEN
COLECAO SEM PARAFUSOS

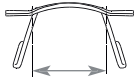

	OPTIONS**				PONTS EUROPE					PONTS ASIE					
	PONT W	PONT P	PONT P VIS	PONT H	XS	S	M	L	XL	XS	S	M	L	XL	
INVISIBLES															
M-5C					16	18						18			
M-7C					16	18						18			
M-9C / Série 1				✓	16	18					16	18			
M-9C / Série 2				✓	16	18					16	18			
M-11C					16	18						18			
M-22	✓	✓	✓		16	18						16			
M-22G	✓	✓	✓		16	18						16			
INTERCHANGEABLES															
M-5C PLUS					16	18						18			
TENDANCES															
M-66C					16	18						18			
M-67C					16	18						18			
M-70C					16	18						18			
M-72C					16	18						18			
M-73C					16	18						18			
M-74C					16	18						18			
M-75C					16	18						18			
M-76C					16	18						18			
M-77C					16	18						18			
M-78C					16	18						18			
M-79C					16	18						18			
M-510C					16	18						18			
M-511C					16	18						18			
M-512C					16	18						18			

* En mm

✓ Disponible - Available - Disponibile - Verfügbar - Disponivel

✓ Standard - Standard - Estándar - Standard - Tipo



Pont P
P bridge
Puente P
Padbrück
Ponte P



Pont P à vis
P bridge with screws
Puente P con tornillos
Padbrück mit Schrauben
Ponte P com parafuso



Pont H
H bridge
Puente H
Padbrück H
Ponte H

PERÇAGES / DRILLINGS

Perçages VIS - Drillings SCREWS

Pont et tenon • Bridge and lug • Nasensteg und backe • Puente y Talón

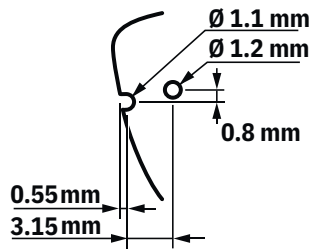

M-22 / 22 G

Pont • Bridge • Nasensteg • Puente

Tenon • Lug • Backe • Talón

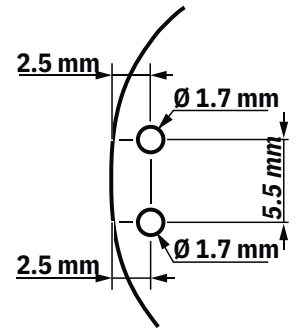
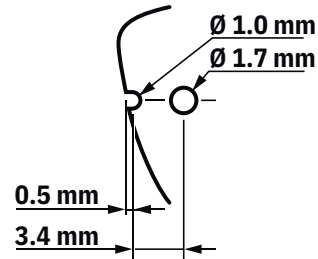

M-JUNIOR

Pont et tenon • Bridge and lug • Nasensteg und backe • Puente y Talón

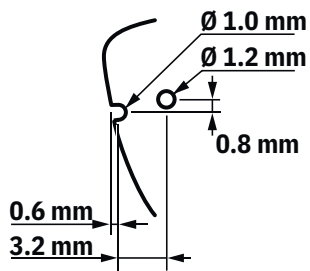

M-JUNIOR-22 / 22 G

Pont • Bridge • Nasensteg • Puente

Tenon • Lug • Backe • Talón

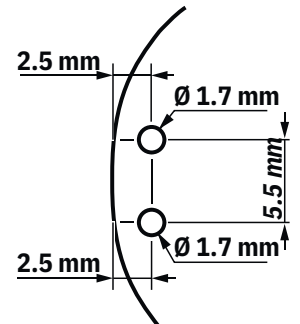
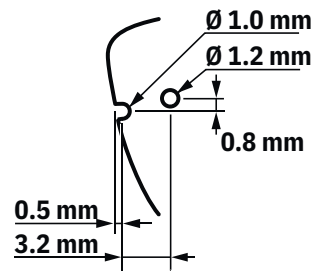

PERÇAGES / DRILLINGS

Perçages CAVALIERS - Drillings without SCR EW

Po nt et tenon • Bridge and lug • Nasensteg und backe • Puente y Talón

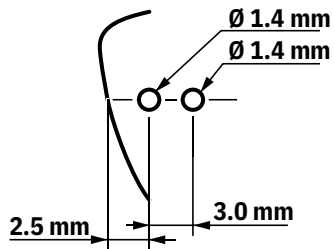

Minima-9C / Minima-11C

Rainage • Grooving • Falten • Arrugando

Tenon • Lug • Backe • Talón

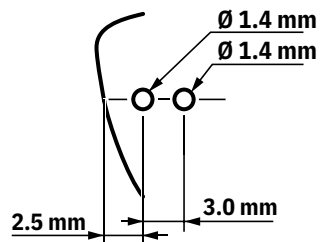
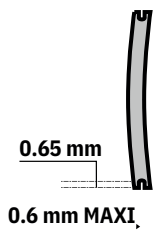

EVO

Rainage • Grooving • Falten • Arrugando

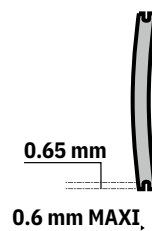

Longueur de fil appropriée (en mm) / Appropriate thread length (mm)

Se référer au tableau pour couper le fil nylon Ø 0.5 mm à la longueur appropriée.
Refer to the table when cutting the Ø 0.5mm nylon thread to the appropriate length.

Forme M-9C Shape M-9C	Longueur de fil Thread length (mm)
F101	120.5
F102	114
F103	116.5
F104	127.5
F207	119
F208	114
F209	120

Forme M-11C Shape M-11C	Longueur de fil Thread length (mm)
DM1	111
DM2	104
DM3	104
DM4	114
DM5	88
DM6	129
DP1	104
DP2	96
DP3	104

Longueur de fil appropriée (en mm) / Appropriate thread length (mm)

Se référer au tableau pour couper le fil nylon Ø 0.5 mm à la longueur appropriée.
Refer to the table when cutting the Ø 0.5mm nylon thread to the appropriate length.

Forme EVO Shape EVO	Longueur de fil Thread length (mm)
EN1	72
EN2	62
EN3	66
EN4	64
EN5	58
EN6	60
EN7	57
EN8	74
EN9	66
EN10	64
EN11	66
EN12	59



COLLECTION "JUNIORS"

JUNIOR-1

① F426-48 / Col. 42



37	Cuivre Copper Cobre Kupfer Cobre
38	Noir Black Negro Schwarz Preto
39	Bleu clair Light blue Azul claro Hellblau Azul claro
43	Gris Gray Gris Grau Cinzentó

44	Violet Purple Violeta Lila Violeta
45	Bleu foncé Dark blue Azul oscuro Dunkelblau Azul oscuro
46	Rose Pink Rosa Rosa Rosa
47	Citron vert Lime Lima Lemongrün Limão verde
48	Miel Honey Miel Honigfarben Mel

40	Cuivre/bleu clair Copper/light blue Cobre/azul claro Kupfer/hellblau Cobre/azul claro
41	Violet/turquoise Purple/turquoise Violeta/turquesa Lila/türkis Violeta/turquesa
42	Turquoise/bleu roi Turquoise/blue Turquesa/azul Türkis/königsblau Turquesa/azul
49	Dégradé Bleu clair/miel Graduated Light Blue/honey Degradado Azul claro/miel Hellblau/honig verlauf Degradadas Azul claro/mel
50	Dégradé Turquoise/violet Graduated Turquoise/purple Degradado Turquesa/violeta Türkis/lila verlauf Degradadas Turquesa/violeta
51	Dégradé Turquoise/rose Graduated Turquoise/pink Degradado Turquesa/rosa Türkis/rosa verlauf Degradadas Turquesa/rosa

LONGUEUR DE BRANCHES

Temple length / Largo de varillas
Bugellänge / Tamanho das hastas 135 mm

PONTS EUROPE

European bridge / Puente europeo
Europäischer Nasensteg
Ponte Europa

XS 14 mm
 S 16 mm
 M
 L
 XL

Disponible - Available - Disponibile - Verfügbar - Disponível
 Standard - Standard - Estándar - Standard - Tipo

JUNIOR-22

① F429-48 / Col. 56



43	Gris Gray Gris Grau Cinzeno
44	Violet Purple Violeta Lila Violeta
47	Citron vert Lime Lima Lemongrün Limão verde
38	Noir Black Negro Schwarz Preto
39	Bleu clair Light blue Azul claro Hellblau Azul claro
56	Dégradé Citron vert/turquoise Graduated Lime/turquoise Degradado Lima/turquesa Lemongrün/türkis verlauf Degradado Lima/turquesa
57	Dégradé Miel/fuchsia Graduated Honey/fuchsia Degradado Miel/fucsia Honigfarben/fuchsia verlauf Degradado Mel/fucsia

LONGUEUR DE BRANCHES

Temple length / Largo de varillas
Bugellänge / Tamanho das hastas **130 mm**

PONTS EUROPE

European bridge / Puente europeo
Europäischer Nasensteg
Ponte Europa

- XS 14 mm
 S 16 mm
 M
 L
 XL

✓ Disponible - Available - Disponibile - Verfügbar - Disponível

✓ Standard - Standard - Estándar - Standard - Tipo

JUNIOR-22G

① F409-48 / Col. Anis



	Anis/noir Acid yellow/black Anis/negro Anis/schwarz Anis/preto
--	--

	Blanc/orange White/orange Blanco/naranja Weiß/orange Branco/laranja
	Bleu marine/bleu Navy/blue Azul marino/azul Marine/blau Azul marinho/azul
	Bleu vert/orange Blue green/orange Azul verdoso/naranja Petrol/orange Azul verdeado/laranja

	Gris/noir Gray/black Gris/negro Grau/schwarz Cinzento/preto
	Jaune/noir Yellow/black Amarillo/negro Gelb/schwarz Amarelo/preto
	Kaki/noir Kahki/black Caqui/negro Kaki/schwarz Căqui/preto

	Noir/bleu Black/blue Negro/azul Schwarz/blau Preto/azul
	Prune/noir Plum/black Ciruela/negro Lila/schwarz Roxo/preto
	Rose/violet Pink/purple Rosa/violeta Rosa/lila Rosa/violeta
	Rouge vif/noir Bright red/black Rojo vivo/negro Feuerrot/schwarz Vermelho vivo/preto

LONGUEUR DE BRANCHES

Temple length / Largo de varillas
Bugellänge / Tamanho das hastas **130 mm**

PONTS EUROPE

European bridge / Puente europeo
Europäischer Nasensteg
Ponte Europa

- XS 14 mm
 S 16 mm
 M
 L
 XL

Disponible - Available - Disponibile - Verfügbar - Disponivel
 Standard - Standard - Estándar - Standard - Tipo

JUNIOR HYBRID-1 CJ1

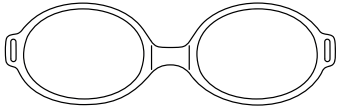

A	B	ED	N
40	30	41	16

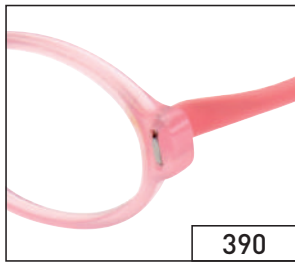

390

Rose brillant/rose
Shiny rose/rose
Rosa brillante/rosa
Rosa glänzend/rosa
Rosa brilhante/rosa

Manchon 
End tip 

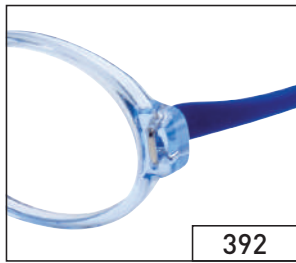

392

Bleu brillant/bleu foncé
Shiny blue/dark blue
Azul brillante/azul oscuro
Blau glänzend/dunkelblau
Azul brilhante/azul escuro

Manchon 
End tip 

LONGUEUR DE BRANCHES

Temple length / Largo de varillas
Bugellänge / Tamanho das hastas

 125 mm

PONTS EUROPE

European bridge
Puente europeo 
Europäischer Nasensteg
Ponte Europa

PONTS "P" ASIE

Asian bridge
Puente asiático 
Asiatischer Nasensteg
Ponte Ásia

LE CLIP SOLAIRE



Clip solaire/vendu séparément
Sun clip/sold accessory separately
Clip solar/vendido por separado
Sonnen Klip/zubehörteil einzeln kaufbar
Clip solar/acessório vendido separadamente
Cat.3 pol.

JUNIOR HYBRID-1 CJ2

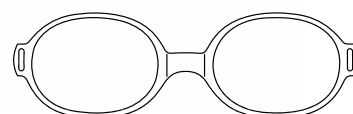

A	B	ED	N
42	32	43	17



364A

Rose pamplemousse brillant/rose
Shiny grapefruit pink/pink
Rosa pomelo brillante/rosa
Rosa Grapefruit glänzend/rosa
Toranja rosada brilhante/rosa

Manchon
End tip 



394

Bleu vert brillant/bleu vert
Shiny blue green/blue green
Azul verdoso brillante/azul verdoso
Petrol glänzend/petrol
Azul verdeado brilhante/azul verdeado

Manchon
End tip 



464A

Gris brillant/aqua
Shiny gray/aqua
Gris brillante/aqua
Grau glänzend/aqua
Cinzento brilhante/aqua

Manchon
End tip 



464B

Gris brillant/fuchsia
Shiny gray/fuchsia
Gris brillante/fuchsia
Grau glänzend/fuchsia
Cinzento brilhante/fuchsia

Manchon
End tip 



547C

Rose/rose
Rose/rose
Rosa/rosa
Rosa/rosa
Rosa/rosa

Manchon
End tip 

LONGUEUR DE BRANCHES

Temple length / Largo de varillas
Bugellänge / Tamanho das hastas

 125 mm

PONTS EUROPE

European bridge
Puente europeo 
Europäischer Nasensteg
Ponte Europa

PONTS "P" ASIE

Asian bridge
Puente asiático 
Asiatischer Nasensteg
Ponte Ásia



LE CLIP SOLAIRE



Clip solaire/vendu séparément
Sun clip/sold accessory separately
Clip solar/vendido por separado
Sonnen Klip/zubehörteil einzeln kaufbar
Clip solar/accessório vendido separadamente
Cat.3 pola.

JUNIOR HYBRID-1 CJ4

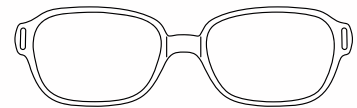

A	B	ED	N
44	31	46	14



399

Prune-cristal brillant/noir
 Shiny plum-crystal/black
 Ciruela-cristal brillante/negro
 Lila-kristall glänzend/schwarz
 Roxo-cristal brilhante/preto

Manchon End tip 

LONGUEUR DE BRANCHES

Temple length / Largo de varillas
 Bugellänge / Tamanho das hastas

✓ 135 mm

PONTS EUROPE

European bridge
 Puente europeo ✓
 Europäischer Nasensteg
 Ponte Europa

PONTS "P" ASIE

Asian bridge
 Puente asiático ✓
 Asiatischer Nasensteg
 Ponte Ásia

LE CLIP SOLAIRE



Clip solaire/vendu séparément
 Sun clip/sold accessory separately
 Clip solar/vendido por separado
 Sonnen Klip/zubehörteil einzeln kaufbar
 Clip solar/accessório vendido separadamente
Cat.3 pol.

JUNIOR HYBRID-1 CJ5



A	B	ED	N
45	30	47	14



556A

Gris-jaune/jaune
Gray-yellow/yellow
Gris-amarillo/amarillo
Grau-gelb/gelb
Cinzeno-amarelo/amarelo

Manchon
End tip



556B

Gris-jaune/gris
Gray-yellow/gray
Gris-amarillo/gris
Grau-gelb/grau
Cinzeno-amarelo/cinzeno

Manchon
End tip



LONGUEUR DE BRANCHES

Temple length / Largo de varillas
Bugellänge / Tamanho das hastas

✓ 135 mm

PONTS EUROPE

European bridge
Puente europeo
Europäischer Nasensteg
Ponte Europa



PONTS "P" ASIE

Asian bridge
Puente asiático
Asiatischer Nasensteg
Ponte Asia



LE CLIP SOLAIRE



Clip solaire/vendu séparément
Sun clip/sold accessory separately
Clip solar/vendido por separado
Sonnen Klip/zubehörteil einzeln kaufbar
Clip solar/accessório vendido separadamente

Cat.3 pola.

JUNIOR HYBRID-1 CJ6

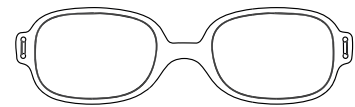

A	B	ED	N
43	31	45	17



464A

Gris brillant/aqua
Shiny gray/aqua
Gris brillante/aqua
Grau glänzend/aqua
Cinzeno brilhante/aqua

Manchon
End tip 



464F

Gris brillant/anis
Shiny gray/acide green
Gris brillante/anis
Grau glänzend/anis
Cinzeno brilhante/anis

Manchon
End tip 



539C

Grenadine/fuchsia
Grenadine/fuchsia
Granate/fucsia
Grenadine/fuchsia
Granadina/fuchsia

Manchon
End tip 

LONGUEUR DE BRANCHES

Temple length / Largo de varillas
Bugellänge / Tamanho das hastas

 125 mm

PONTS EUROPE

European bridge
Puente europeo
Europäischer Nasensteg
Ponte Europa

PONTS "P" ASIE

Asian bridge
Puente asiático
Asiatischer Nasensteg
Ponte Ásia



LE CLIP SOLAIRE



Clip solaire/vendu séparément
Sun clip/sold accessory separately
Clip solar/vendido por separado
Sonnen Klip/zubehörteil einzelnd kaufbar
Clip solar/accessório vendido separamente
Cat.3 pola.

JUNIOR HYBRID-1 CJ11

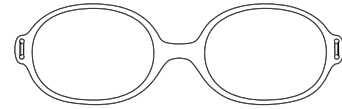

A	B	ED	N
45	34	45	17



523A

Fuchsia-marine/noir
Fuchsia-navy/black
Fucsia-azul marino/negro
Fuchsia-marine/schwarz
Fucsia-azul marinho/preto

Manchon End tip 



527C

Bleu-rouge/bleu marine
Blue-red/navy
Azul-rojo/azul marino
Blau-rot/marine
Azul-vermelho/azul marinho

Manchon End tip 



527D

Bleu-rouge/rouge vif
Blue-red/bright red
Azul-rojo/rojo vivo
Blau-rot/grell rot
Azul-vermelho/vermelho vivo

Manchon End tip 



563C

Indigo/blanc
Indigo/white
Índigo/blanco
Índigoblau/weib
Índigo/branco

Manchon End tip 



563D

Indigo/bleu marine
Indigo/navy
Índigo/azul marinho
Índigoblau/marine
Índigo/azul marino

Manchon End tip 



571A

Fuchsia-bleu/fuchsia
Fuchsia-blue/fuchsia
Fucsia-azul/fucsia
Fuchsia-bleu/fucsia
Fucsia-azul/fucsia

Manchon End tip 



571B

Fuchsia-bleu/aqua
Fuchsia-blue/aqua
Fucsia-azul/aqua
Fucsia-bleu/wasserblau
Fucsia-azul/aqua

Manchon End tip 

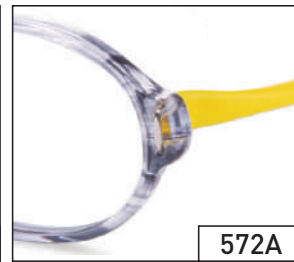

572A

Gris strié/jaune
Gray stripes/yellow
Gris estriado/amarillo
Grau gestreift/gelb
Cinzeno estriado/amarello

Manchon End tip 

LONGUEUR DE BRANCHES

Temple length / Largo de varillas
Bugellänge / Tamanho das hastes

 135 mm

PONTS EUROPE

European bridge
Puente europeo
Europäischer Nasensteg
Ponte Europa



PONTS "P" ASIE

Asian bridge
Puente asiático
Asiatischer Nasensteg
Ponte Asia



LE CLIP SOLAIRE



Clip solaire/vendu séparément
Sun clip/sold accessory separately
Clip solar/vendido por separado
Sonnen Klip/zubehörteil einzeln kaufbar
Clip solar/acessório vendido separadamente

Cat.3 pola.

JUNIOR HYBRID-1 CJ12

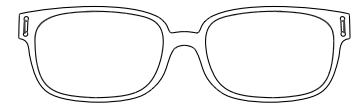

A	B	ED	N
48	33	51	15



526A

Noir-cristal/bleu vert
Black-crystal/bleu green
Negro-cristal/azul verdoso
Schwarz-kristall/petrol
Preto-cristal/azul verdeado

Manchon
End tip 



526B

Noir-cristal/anis
Black-crystal/acid green
Negro-cristal/anis
Schwarz-kristall/anis
Preto-cristal/anis

Manchon
End tip 



527A

Bleu-rouge/blanc
Blue-red/white
Azul-rojo/blanco
Blau-rot/weiß
Azul-vermetho/branco

Manchon
End tip 

LONGUEUR DE BRANCHES

Temple length / Largo de varillas
Bugellänge / Tamanho das hastas

 135 mm

PONTS EUROPE

European bridge
Puente europeo 
Europäischer Nasensteg
Ponte Europa

PONTS "P" ASIE

Asian bridge
Puente asiático 
Asiatischer Nasensteg
Ponte Asia

JUNIOR HYBRID-1 CJ14

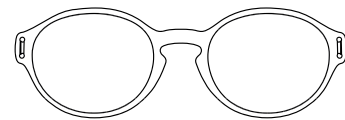

A	B	ED	N
43	35.5	44	17



535A

Bleu marine-vert/bleu marine
Navy-green/navy
Azul marino-verde/azul marino
Marine-grün/marine
Azul marinho-verde/azul marinho

Manchon
End tip 



558A

Ecaïlle brun-bleu/bleu foncé
Tortoise brown-blue/dark blue
Carey marron-azul/azul oscuro
Schildpatt braun-blau/dunkelblau
Escama castanho-azul/azul escuro

Manchon
End tip 



558B

Ecaïlle brun-bleu/orange foncé
Tortoise brown-blue/dark orange
Carey marron-azul/naranja oscuro
Schildpatt braun-blau/dunkel orange
Escama castanho-azul/laranja escuro

Manchon
End tip 



652A

Ecaïlle rouge/bleu foncé
Tortoise red/dark blue
Carey roja/azul oscuro
Schildpatt rot/dunkelblau
Escama vermelho/azul escuro

Manchon
End tip 

LONGUEUR DE BRANCHES

Temple length / Largo de varillas
Bugellänge / Tamanho das hastas

 135 mm

PONTS EUROPE

European bridge
Puente europeo 
Europäischer Nasensteg
Ponte Europa

PONTS "P" ASIE

Asian bridge
Puente asiático 
Asiatischer Nasensteg
Ponte Asia

JUNIOR HYBRID-1 CJ15

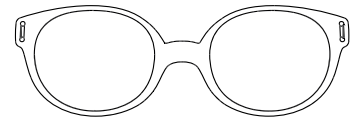

A	B	ED	N
44	37	46	18



537A

Violet pailleté brillant/prune
Shiny glitter purple/plum
Violeta con lentejuelas/ciruela
Lila pailletiert glänzend/lila
Violeta com lentejoulas/roxo

Manchon 
End tip 



537B

Violet pailleté brillant/violet
Shiny glitter purple/purple
Violeta con lentejuelas/violeta
Lila pailletiert glänzend/lila
Violeta com lentejoulas/violeta

Manchon 
End tip 



653A

Ecaïlle bleu-rose/violet
Tortoise blue-pink/purple
Carey azul-rosa/violeta
Schildpatt azur-rosa/lila
Escama azul-rosa/violeta

Manchon 
End tip 

LONGUEUR DE BRANCHES

Temple length / Largo de varillas
Bugellänge / Tamanho das hastas

 135 mm

PONTS EUROPE

European bridge 
Puente europeo
Europäischer Nasensteg
Ponte Europa

PONTS "P" ASIE

Asian bridge 
Puente asiático
Asiatischer Nasensteg
Ponte Ásia

 Standard – Standard – Estándar – Standard – Tipo

 Disponible – Available – Disponibile – Verfügbar – Disponivel

JUNIOR HYBRID-2 CJ16

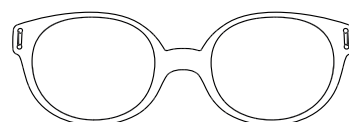

A	B	ED	N
47	37	51	14



545A

Fuchsia dégradé/rouge cerise
Graduated fuchsia/cherry red
Fucsia degradado/cereza
fucsia verlauf/kirsch rot
Fucsia degradado/cereza

Manchon
End tip



545B

Fuchsia dégradé/rouge vif
Graduated fuchsia/bright red
Fucsia degradado/rojo vivo
Fucsia verlauf/grell rot
Fucsia degradado/vermelho vivo

Manchon
End tip



546A

Ecaille bleu-parme/parme
Tortoise blue-parma/parma
Carey azul-parma/parma
Schildpatt blau-parma/parma
Escama azul-parma/parma

Manchon
End tip



583B

Ecaille-vieux rose/noir
Tortoise-shell pink/black
Carey-Rosa escamosa/negro
Schildpatt-altrosa/schwarz
Escama-rosa/preto

Manchon
End tip



619B

Aubergine dégradé/prune
Dark purple graduated/plum
Violeta oscuro degradado/ciruela
Aubergine verlauf/lila
Berinjela degradado/roxo

Manchon
End tip

LONGUEUR DE BRANCHES

Temple length / Largo de varillas
Bugellänge / Tamanho das hastas

✓ 120 mm ✓ 130 mm ✓ 140 mm

PONTS EUROPE

European bridge
Puente europeo ✓
Europäischer Nasensteg
Ponte Europa

PONTS "P" ASIE

Asian bridge
Puente asiático ✓
Asiatischer Nasensteg
Ponte Asia

✓ Standard – Standard – Estándar – Standard – Tipo

✓ Disponible – Available – Disponibile – Verfügbar – Disponível

JUNIOR HYBRID-2 CJ17

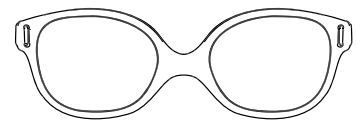

A	B	ED	N
41	33	44	15



548A

Parme pailleté brillant/parme
Shiny glitter parma/parma
Parma con lentejuelas/parma
Parma pailletiert glänzend/parma
Parma com lantejoulas/parma

Manchon
End tip



548B

Parme pailleté brillant/prune
Shiny glitter parma/plum
Parma con lentejuelas/ciruela
Parma pailletiert glänzend/lila
Parma com lantejoulas/roxo

Manchon
End tip



549A

Bleu pailleté brillant/bleu givré
Shiny glitter blue/frosted blue
Azul con lentejuelas/azul escarchado
Blau pailletiert glänzend/blau gefrostet
Azul com lantejoulas/azul gelo

Manchon
End tip



LONGUEUR DE BRANCHES

Temple length / Largo de varillas
Bugellänge / Tamanho das hastas

✓ 120 mm ✓ 130 mm ✓ 140 mm

PONTS EUROPE

European bridge
Puente europeo ✓
Europäischer Nasensteg
Ponte Europa

PONTS "P" ASIE

Asian bridge
Puente asiático ✓
Asiatischer Nasensteg
Ponte Asia

✓ Standard – Standard – Estándar – Standard – Tipo
✓ Disponible – Available – Disponibile – Verfügbar – Disponível

JUNIOR HYBRID-2 CJ18



552B

Violet-kaki/prune
Purple-kahki/plum
Violeta-caqui/cirueta
Lila-kaki/lila
Violeta-caqui/roxo

Manchon
End tip

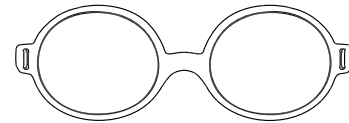

A	B	ED	N
43	37	43	16

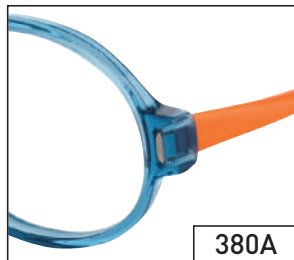

380A

Bleu-vert/orange foncé
Shiny blue green/dark orange
Azul verdoso brillante/naranja oscuro
Petrol glänzend/dunkel orange
Azul verdeado brillante/laranja escuro

Manchon
End tip

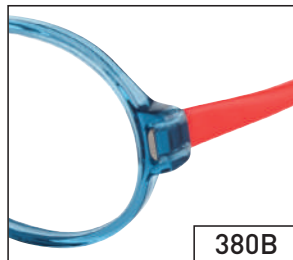

380B

Bleu-vert/rouge vif
Shiny blue green/bright red
Azul verdoso brillante/rojo vivo
Petrol glänzend/grell rot
Azul verdeado brilhante/vermelho vivo

Manchon
End tip

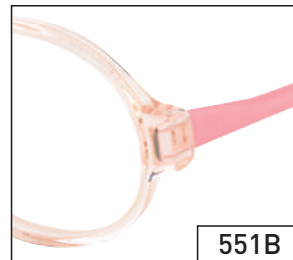

551B

Rose pastel brillant/rose
Shiny pastel rose/rose
Pastel rosa brillante/rosa
Pastellrosa glänzend/rosa
Rosa claro brilhante/rosa

Manchon
End tip



552A

Violet-kaki/kaki
Purple-kahki/kahki
Violeta-caqui/caqui
Lila-kaki/kaki
Violeta-caqui/caqui

Manchon
End tip



555C

Vert-jaune/bleu vert
Green-yellow/bleu green
Verde-amarillo/azul verdoso
Grün-gelb/petrol
Verde amarelo/azul verdeado

Manchon
End tip



573A

Caramel/orange foncé
Toffee/dark orange
Caramelo/naranja oscuro
Karamell/dunkel orange
Caramelo/laranja escuro

Manchon
End tip



573B

Caramel/bleu marine
Toffee/navy
Caramelo/azul marinho
Karamell/marine
Caramelo/azul marino

Manchon
End tip



582A

Ecaille-bleu canard/bleu vert
Tortoise-Peacock blue/blue green
Carrey-azul verdoso/azul verdoso
Schildpatt-petrol/petrol
Escama-verdeado/azul verdeado

Manchon
End tip

LONGUEUR DE BRANCHES

Temple length / Largo de varillas
Bugellänge / Tamanho das hastes

✓ 120 mm ✓ 130 mm ✓ 140 mm

PONTS EUROPE

European bridge
Puente europeo ✓
Europäischer Nasensteg
Ponte Europa

PONTS "P" ASIE

Asian bridge
Puente asiático ✓
Asiatischer Nasensteg
Ponte Àsia

✓ Standard – Standard – Estándar – Standard – Tipo
✓ Disponible – Available – Disponibile – Verfügbar – Disponivel

JUNIOR HYBRID-2 CJ19



553B

Gris/jaune
Gray/yellow
Gris/amarillo
Grau/Gelb
Cinzentto/amarelo

Manchon
End tip



A	B	ED	N
47	33	49	14



535C

Bleu marine-vert/bleu marine
Navy-green/navy
Azul marino-verde/azul marino
Marine-grün/marine
Azul marinho-verde/azul marinho

Manchon
End tip



535D

Bleu marine-vert/bleu marine
Navy-green/navy
Azul marino-verde/azul marino
Marine-grün/marine
Azul marinho-verde/azul marinho

Manchon
End tip



574A

Rouge fumé/blanc
Smoke red/white
Rojo ahumado/blanco
Rot raucht/Weiß
Vermelho fumado/branco

Manchon
End tip



574B

Rouge fumé/noir
Smoke red/black
Rojo ahumado/negro
Rot raucht/schwarz
Vermelho fumado/preto

Manchon
End tip



585A

Bleu gris-vert fluo/bleu marine
Blue grey-green fluorescent/navy
Azul gris-verde fluorescente/azul marinho
Blau grau-grün fluo/marine
Azul cinzento-verde fluorescente/azul marino

Manchon
End tip



585B

Bleu gris-vert fluo/anis
Blue grey-green fluorescent/acid green
Azul gris-verde fluorescente/anis
Blau grau-grün fluo/anis
Azul cinzento-verde fluorescente/anis

Manchon
End tip



LONGUEUR DE BRANCHES

Temple length / Largo de varillas
Bugellänge / Tamanho das hastas

✓ 120 mm ✓ 130 mm ✓ 140 mm

PONTS EUROPE

European bridge
Puente europeo ✓
Europäischer Nasensteg
Ponte Europa

PONTS "P" ASIE

Asian bridge
Puente asiático ✓
Asiatischer Nasensteg
Ponte Asia

✓ Standard – Standard – Estándar – Standard – Tipo

✓ Disponible – Available – Disponível – Verfügar – Disponível

JUNIOR HYBRID-2 CJ20

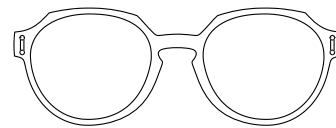

A	B	ED	N
47	41	50	18



516C

Bleu marine-rouge brillant/bleu foncé
Shiny navy-red/dark blue
Azul marino-rojo brillante/azul oscuro
Marine-rot glänzend/dunkelblau
Azul marinho-vermelho brilhante/azul escuro

Manchon
End tip



654A

Bleu fumé/anis
Smoke blue/acid green
Azul ahumado/anís
Rauchblau/anis
Azul fumado/anis

Manchon
End tip



LONGUEUR DE BRANCHES

Temple length / Largo de varillas
Bugellänge / Tamanho das hastes

✓ 120 mm ✓ 130 mm ✓ 140 mm

PONTS EUROPE

European bridge
Puente europeo ✓
Europäischer Nasensteg
Ponte Europa

PONTS "P" ASIE

Asian bridge
Puente asiático ✓
Asiatischer Nasensteg
Ponte Ásia

✓ Standard – Standard – Estándar – Standard – Tipo

✓ Disponible – Available – Disponível – Verfügbar – Disponível

JUNIOR HYBRID-2 CJ21



A	B	ED	N
48	34	51	16



518C

Bleu foncé-jaune brillant/bleu foncé
Shiny dark blue/dark blue
Azul oscuro-amarillo brillante/azul oscuro
Dunkelblau-gelb glänzend/dunkelblau
Azul oscuro-amarelo brilhante/azul escuro

Manchon End tip 



558C

Ecaille brun-bleu/orange foncé
Tortoise brown-blue/dark orange
Carey marrón-azul/naranja oscuro
Schildpatt braun-blau/dunkel orange
Escama castanho-azul/laranja escuro

Manchon End tip 



558D

Ecaille brun-bleu/bleu foncé
Tortoise brown-blue/dark blue
Carey marrón-azul/azul oscuro
Schildpatt braun-blau/dunkelblau
Escama castanho-azul/azul escuro

Manchon End tip 



619C

Aubergine dégradé/prune
Dark purple graduated/plum
Violeta oscuro degradado/ciruela
Aubergine Verlauf/lila
Berinjela degradado/roxo

Manchon End tip 

LONGUEUR DE BRANCHES

Temple length / Largo de varillas
Bugellänge / Tamanho das hastas

✓120 mm ✓130 mm ✓140 mm

PONTS EUROPE

European bridge
Puente europeo ✓
Europäischer Nasensteg
Ponte Europa

PONTS "P" ASIE

Asian bridge
Puente asiático ✓
Asiatischer Nasensteg
Ponte Asia

✓ Standard – Standard – Estándar – Standard – Tipo

✓ Disponible – Available – Disponibile – Verfügbar – Disponível

JUNIOR HYBRID-2 CJ23



A	B	ED	N
50	37.5	53	16



535E

Bleu marine-vert/bleu marine
Navy-green/navy
Azul marino-verde/azul marino
Marine-grün/marine
Azul marinho-verde/azul marinho

Manchon
End tip



657A

Gris fumé/anis
Smoke gray/acid green
Gris ahumado/anis
Rauchgrau/anis
Cinzeno fumado/anis

Manchon
End tip



658A

Noir-orange/orange foncé
Black-orange/dark orange
Negro-naranja/naranja oscuro
Schwarz-orange/dunkel orange
Preto-laranja/laranja escuro

Manchon
End tip



LONGUEUR DE BRANCHES

Temple length / Largo de varillas
Bugellänge / Tamanho das hastas

✓ 120 mm ✓ 130 mm ✓ 140 mm

PONTS EUROPE

European bridge
Puente europeo ✓
Europäischer Nasensteg
Ponte Europa

PONTS "P" ASIE

Asian bridge
Puente asiático ✓
Asiatischer Nasensteg
Ponte Ásia

✓ Standard – Standard – Estándar – Standard – Tipo

✓ Disponible – Available – Disponibile – Verfügbar – Disponível

JUNIOR HYBRID-2 CJ30

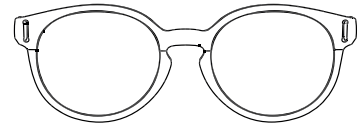

A	B	ED	N
42	36	44	15



575A

Marron-bleu fumé/orange foncé
Brown-blue smoked/dark orange
Marrón-azul ahumado/naranja oscuro
Braun-blau-geräuchert/dunkel orange
Castanho-azul-escuro fumado/laranja escuro

Manchon
End tip 



575B

Marron-bleu fumé/violet
Brown-blue smoked/purple
Marrón-azul ahumado/violeta
Braun-blau-geräuchert/lila
Castanho-azul-escuro fumado/violeta

Manchon
End tip 



576A

Camel fumé/bleu marine
Smoke camel/navy
Camel ahumado/azul marinho
Kamel raucht/marine
Camelo fumado/azul marino

Manchon
End tip 



577A

Ecaïlle kaki/kaki
Khaki tortoise/kahki
Carey kaki/caqui
Khaki-Schildpatt/kaki
Escama cáqui/caqui

Manchon
End tip 

LONGUEUR DE BRANCHES

Temple length / Largo de varillas
Bugellänge / Tamanho das hastas

✓ 120 mm ✓ 130 mm ✓ 140 mm

PONTS EUROPE

European bridge
Puente europeo
Europäischer Nasensteg
Ponte Europa



PONTS "P" ASIE

Asian bridge
Puente asiático
Asiatischer Nasensteg
Ponte Asia



✓ Standard – Standard – Estándar – Standard – Tipo
✓ Disponible – Available – Disponibile – Verfügbar – Disponível

JUNIOR HYBRID-2 CJ31



578B

Bleu strié/bleu givré
Blue stripes/frosted blue
Azul estriado/azul escarchado
Blau gestreift/blau gefrostet
Azul estriado/azul gelo

Manchon
End tip

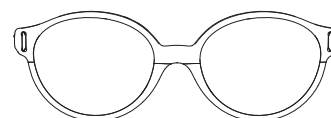

A	B	ED	N
45	37	47	15



578A

Bleu strié/rose
Blue stripes/pink
Azul estriado/rosa
Blau gestreift/rosa
Azul estriado/rosa

Manchon
End tip



579A

Violet fumé-rose pâle/rose
Smoke purple-pale pink/pink
Violeta ahumado-rosa pálido/rosa
Rauchviolett-Blassrosa/rosa
Violeta fumado-rosa pálido/rosa

Manchon
End tip



579B

Violet fumé-rose pâle/violet
Smoke purple-pale pink/purple Violeta
ahumado-rosa pálido/violeta
Rauchviolett-Blassrosa/lila
Violeta fumado-rosa pálido/violeta

Manchon
End tip



581A

Bleu foncé-coral/bleu marine
Dark blue-coral/navy
Azul oscuro-coral/azul marinho
Dunkelblau-Koralle/marine
Azul oscuro-coral/azul marino

Manchon
End tip



LONGUEUR DE BRANCHES

Temple length / Largo de varillas
Bugellänge / Tamanho das hastas

✓ 120 mm ✓ 130 mm ✓ 140 mm

PONTS EUROPE

European bridge
Puente europeo ✓
Europäischer Nasensteg
Ponte Europa

PONTS "P" ASIE

Asian bridge
Puente asiático ✓
Asiatischer Nasensteg
Ponte Asia

✓ Standard – Standard – Estándar – Standard – Tipo

✓ Disponible – Available – Disponibile – Verfügbar – Disponível

JUNIOR HYBRID-2 CJ34

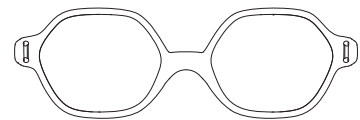

A	B	ED	N
42	34	43	15



592A

Prune pailleté/prune
Plum glitter/plum
Ciruela con lentejuelas/ciruela
Lila pailletiert/lila
Roxo con lentejoulas/roxo

Manchon
End tip



592B

Prune pailleté/rose
Plum glitter/rose
Ciruela con lentejuelas/rosa
Lila pailletiert/rosa
Roxo con lentejoulas/rosa

Manchon
End tip



593A

Mosaïque prune/prune
Mosaic plum/plum
Mosaico ciruela/ciruela
Mosaik lila/lila
Mosaico roxo/roxo

Manchon
End tip



593B

Mosaïque prune/violet
Mosaic plum/purple
Mosaico ciruela/violeta
Mosaik lila/lila
Mosaico roxo/violeta

Manchon
End tip

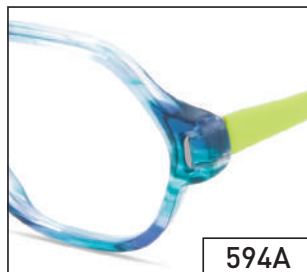

594A

Bleu-vert fumé/anis
Smoked blue green/acid green
Azul verdoso ahumado/anís
Petrol rauchte/anís
Azul-verde fumado/anís

Manchon
End tip



594B

Bleu-vert fumé/bleu vert
Smoked blue green/blue green
Azul verdoso ahumado/azul verdoso
Petrol rauchte/petrol
Azul-verde fumado/azul-verde

Manchon
End tip



LONGUEUR DE BRANCHES

Temple length / Largo de varillas
Bugellänge / Tamanho das hastes

✓ 120 mm ✓ 130 mm ✓ 140 mm

PONTS EUROPE

European bridge
Puente europeo ✓
Europäischer Nasensteg
Ponte Europa

PONTS "P" ASIE

Asian bridge
Puente asiático ✓
Asiatischer Nasensteg
Ponte Asia

✓ Standard – Standard – Estándar – Standard – Tipo

✓ Disponible – Available – Disponibile – Verfügbar – Disponível

JUNIOR HYBRID-2 CJ35



A	B	ED	N
42	36	42	16



380G

Bleu vert/jaune
Blue green/yellow
Azul verdoso/amarillo
Petrol/gelb
Azul-verde/amarelo

Manchon
End tip 



380H

Bleu vert/bleu vert
Blue green/blue green
Azul verdoso/azul verdoso
Petrol/petrol
Azul-verde/azul-verde

Manchon
End tip 

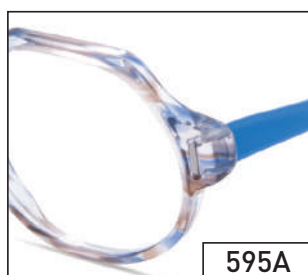

595A

Bleu-brun fumé/bleu foncé
Smoked blue-brown/dark blue
Azul-marrón ahumado/azul oscuro
Blau-braun rauchte/dunkelblau
Azul-castanho fumado/azul escuro

Manchon
End tip 

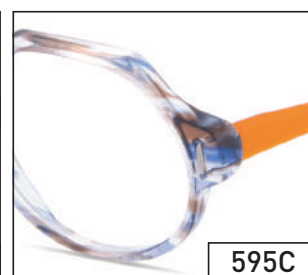

595C

Bleu-brun fumé/orange foncé
Smoked blue-brown/dark orange
Azul-marrón ahumado/naranja oscuro
Blau-braun rauchte/dunkel orange
Azul-castanho fumado/laranja escuro

Manchon
End tip 



596A

Dégradé violet-rose/rose
Purple-pink graduated/rose
Degradado violeta-rosa/rosa
Violett-rosa verlauf/rosa
Gradiente violeta-rosa/rosa

Manchon
End tip 





596B

Dégradé violet-rose/prune
Purple-pink graduated/plum
Degradado violeta-rosa/ciruela
Violett-rosa verlauf/lila
Gradiente violeta-rosa/roxo

Manchon
End tip 

LONGUEUR DE BRANCHES

Temple length / Largo de varillas
Bugellänge / Tamanho das hastas

 120 mm  130 mm  140 mm

PONTS EUROPE

European bridge
Puente europeo 
Europäischer Nasensteg
Ponte Europa

PONTS "P" ASIE

Asian bridge
Puente asiático 
Asiatischer Nasensteg
Ponte Ásia

 Standard – Standard – Estándar – Standard – Tipo

 Disponible – Available – Disponibile – Verfügbar – Disponível

JUNIOR HYBRID-2 CJ36

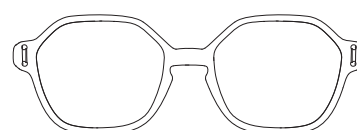

A	B	ED	N
44	37	47	15



590D

Bleu denim/rouge cerise
Denim blue/cherry red
Azul vaquero/cereza
Denimblau/kirsch rot
Azul denim/cereza

Manchon 
End tip



590E

Bleu denim/blanc
Denim blue/white
Azul vaquero/blanco
Denimblau/weiß
Azul denim/branco

Manchon 
End tip



597A

Caramel fumé/bleu marine
Smoked caramel/navy
Caramelo ahumado/azul marinho
Rauchkaramell/marine
Caramelo fumado/azul marinho

Manchon 
End tip



597B

Caramel fumé/jaune
Smoked caramel/yellow
Caramelo ahumado/amarillo
Rauchkaramell/gelb
Caramelo fumado/amarelo

Manchon 
End tip



598A

Prune-vert d'eau/prune
Plum-water green/plum
Ciruela-verde agua/ciruela
Lila-Wassergrün/tila
Roxo-verde água/roxo

Manchon 
End tip



598B

Prune-vert d'eau/bleu givré
Plum-water green/frosted blue
Ciruela-verde agua/azul escarchado
Lila-Wassergrün/blau gefrostet
Roxo-verde água/azul gelo

Manchon 
End tip

LONGUEUR DE BRANCHES

Temple length / Largo de varillas
Bugellänge / Tamanho das hastes

✓ 120 mm ✓ 130 mm ✓ 140 mm

PONTS EUROPE

European bridge
Puente europeo ✓
Europäischer Nasensteg
Ponte Europa

PONTS "P" ASIE

Asian bridge
Puente asiático ✓
Asiatischer Nasensteg
Ponte Asia

✓ Standard – Standard – Estándar – Standard – Tipo

✓ Disponible – Available – Disponibile – Verfügbar – Disponível

JUNIOR HYBRID-2 CJ37



A	B	ED	N
45	37	48	16



589D

Kaki/prune
Kahki/plum
Caqui/cirueta
khaki/lila
Caqui/roxo

Manchon
End tip 



589E

Kaki/kaki
Kahki/kahki
Caqui/caqui
khaki/khaki
Caqui/caqui

Manchon
End tip 



599A

Dégradé bleu-rose/bleu marine
Bleu-pink graduated/navy
Degradado azul-rosa/azul marinho
Blau-rosa verlauf/marine
Gradiente azul-rosa/azul marinho

Manchon
End tip 



599B

Dégradé bleu-rose/prune
Bleu-pink graduated/plum
Degradado azul-rosa/cirueta
Blau-rosa verlauf/lila
Gradiente azul-rosa/roxo

Manchon
End tip 



659A

Mosaïque bleu/bleu foncé
Mosaic blue/dark blue
Mosaico azul/azul oscuro
Mosaik blau/dunkelblau
Mosaico azul/azul escuro

Manchon
End tip 





659B

Mosaïque bleu/noir
Mosaic blue/black
Mosaico azul/negro
Mosaik blau/schwarz
Mosaico azul-preto

Manchon
End tip 

LONGUEUR DE BRANCHES

Temple length / Largo de varillas
Bugellänge / Tamanho das hastas

 120 mm  130 mm  140 mm

PONTS EUROPE

European bridge
Puente europeo 
Europäischer Nasensteg
Ponte Europa

PONTS "P" ASIE

Asian bridge
Puente asiático 
Asiatischer Nasensteg
Ponte Ásia

 Standard – Standard – Estándar – Standard – Tipo

 Disponible – Available – Disponível – Verfügbar – Disponivel

JUNIOR HYBRID-2 CJ38

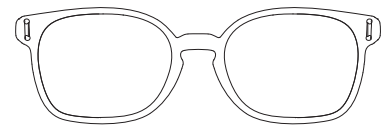

A	B	ED	N
46	36	49	16



660A

Dégradé bleu-vert/bleu vert
Blue green graduated/blue green
Degradado azul-verde/azul verdoso
Blau-grün verlauf/petrol
Gradiente azul-verde/azul-verde

Manchon
End tip



660B

Dégradé bleu-vert/anis
Blue green graduated/acid green
Degradado azul-verde/anis
Blau-grün verlauf/anis
Gradiente azul-verde/anis

Manchon
End tip



661C

Dégradé gris-beige/orange foncé
Gray-beige graduated/dark orange
Degradado gris-beige/naranja oscuro
Grau-beige verlauf/dunkel orange
Gradiente cinzento-bege/laranja escuro

Manchon
End tip



661B

Dégradé gris-beige/noir
Gray-beige graduated/black
Degradado gris-beige/negro
Grau-beige verlauf/schwarz
Gradiente cinzento-bege/preto

Manchon
End tip



662A

Ecaille-bleu brillant/bleu vert
Shiny blue tortoise/blue green
Carey-azul brillante/azul verdoso
Schildpatt-blau glänzend/petrol
Escama-azul brilhante/azul-verde

Manchon
End tip



662B

Ecaille-bleu brillant/blanc
Shiny blue tortoise/white
Carey-azul brillante/blanco
Schildpatt-blau glänzend/weiß
Escama-azul brilhante/branco

Manchon
End tip



LONGUEUR DE BRANCHES

Temple length / Largo de varillas
Bugellänge / Tamanho das hastes

✓ 120 mm ✓ 130 mm ✓ 140 mm

PONTS EUROPE

European bridge
Puente europeo ✓
Europäischer Nasensteg
Ponte Europa

PONTS "P" ASIE

Asian bridge
Puente asiático ✓
Asiatischer Nasensteg
Ponte Asia

✓ Standard – Standard – Estándar – Standard – Tipo

✓ Disponible – Available – Disponibile – Verfügbar – Disponível

JUNIOR HYBRID-3 CJ24

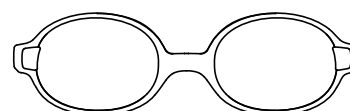

A	B	ED	N
42	32	43	17



560C

Baby rose/rose poudré
Baby pink/powder pink
Bebé rosa/rosa palido
Rosa baby/altrosa
Bebé rosa/rosa palido



560D

Baby rose/lie de vin
Baby pink /wine
bebé rosa/poso de vino
rosa baby/weinrot
bebé rosa/bordô



561A

Bleu canard/bleu vert
Peacock blue/bleu green
Azul verdoso/azul verdoso
Petrol/petrol
Verdeado/Azul verdeado

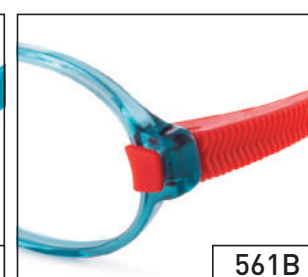

561B

Bleu canard/rouge
Peacock blue/red
Azul verdoso/rojo
Petrol/rot
Verdeado/vermelho

LONGUEUR DE BRANCHES

Temple length / Largo de varillas
Bugellänge / Tamanho das hastas

✓ 120 mm ✓ 130 mm

PONTS EUROPE

European bridge
Puente europeo ✓
Europäischer Nasensteg
Ponte Europa

PONTS "P" ASIE

Asian bridge
Puente asiático ✓
Asiatischer Nasensteg
Ponte Asia

✓ Standard – Standard – Estándar – Standard – Tipo

✓ Disponible – Available – Disponibile – Verfügbar – Disponível

JUNIOR HYBRID-3 CJ25

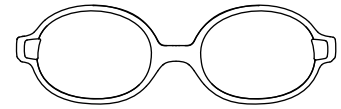

A	B	ED	N
44	34	45	17



562C

Corail/fuchsia
Coral/fuchsia
Coral/fucsia
Koralle/fuchsia
Coral/fúcsia



562D

Corail/lie de vin
Coral/wine
Coral/poso de vino
Koralle/weinrot
Coral/bordô



562E

Corail/pêche
Coral/dark purple
Coral/melocotón
Koralle/pfirsich
Coral/pêssego



563A

Indigo/bleu roi
Indigo/blue
Indigo/azul
Indigoblau/königsblau
Indigo/azul real

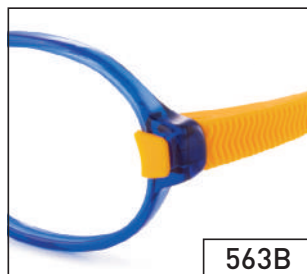

563B

Indigo/jaune
Indigo/yellow
Índigo/amarillo
Indigoblau/gelb
Índigo/amarelo

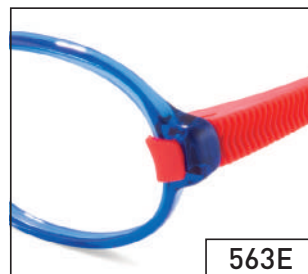

563E

Indigo/rouge
Indigo/red
índigo/rojo
Indigoblau/rot
índigo/vermelho

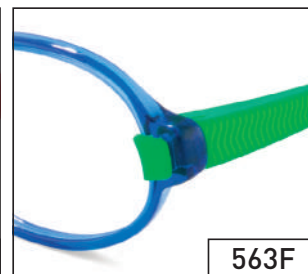

563F

Indigo/vert vif
Indigo/bright green
índigo/verde vivo
Indigoblau/apfelgrün
índigo/verde vivo

LONGUEUR DE BRANCHES

Temple length / Largo de varillas
Bugellänge / Tamanho das hastes

✓ 120 mm ✓ 130 mm

PONTS EUROPE

European bridge
Puente europeo ✓
Europäischer Nasensteg
Ponte Europa

PONTS "P" ASIE

Asian bridge
Puente asiático ✓
Asiatischer Nasensteg
Ponte Ásia

✓ Standard – Standard – Estándar – Standard – Tipo

✓ Disponible – Available – Disponibile – Verfügbar – Disponível

JUNIOR HYBRID-3 CJ27



A	B	ED	N
45	32	47	17



565C

Cassis/fuchsia
Cassis/fuchsia
Grosella negra/fucsia
Cassis/fuchsia
Cassis/fucsia



565D

Cassis/rose poudré
Cassis/powder pink
Grosella negra/rosa palido
Cassis/altrosa
Cassis/rosa palido



566A

Marine cristal/vert vif
Crystal navy/bright green
Azul marinho cristal/verde vivo
Marine kristall/apfelgrün
Azul marinho cristal/verde vivo



566B

Marine cristal/bleu roi
Crystal navy/blue
Azul marinho cristal/azul
Marine kristall/königsblau
Azul marinho cristal/azul real



566C

Marine cristal/rouge
Crystal navy/red
Azul marinho cristal/rojo
Marine kristall/rot
Azul marinho cristal/vermetho



566D

Marine cristal/jaune
Crystal navy/yellow
Azul marinho cristal/amarillo
Marine kristall/gelb
Azul marinho cristal/amarelo

LONGUEUR DE BRANCHES

Temple length / Largo de varillas
Bugellänge / Tamanho das hastes

✓ 120 mm ✓ 130 mm

PONTS EUROPE

European bridge
Puente europeo ✓
Europäischer Nasensteg
Ponte Europa

PONTS "P" ASIE

Asian bridge
Puente asiático ✓
Asiatischer Nasensteg
Ponte Asia

✓ Standard – Standard – Estándar – Standard – Tipo

✓ Disponible – Available – Disponibile – Verfügbar – Disponível

JUNIOR HYBRID-3 CJ28

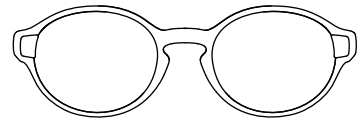

A	B	ED	N
43	35,5	45	17



567A
 Grenat/bleu roi
 Garnet/blue
 Granate/azul
 Granat/königsblau
 Granada/azul real



567B
 Grenat/rouge
 Garnet/Red
 Granate/rojo
 Granat/rot
 Granada/vermelho



568A
 Bleu gris/vert vif
 Gray blue/bright green
 Gris azulado/verde vivo
 Blau grau/apfelgrün
 Azul cinzento/verde vivo



568B
 Bleu gris/jaune
 Gray blue/yellow
 Gris azulado/amarillo
 Blau grau/gelb
 Azul cinzento/amarelo



568C
 Bleu gris/rose poudré
 Gray blue/powder pink
 Gris azulado/rosa palido
 Blau grau/altrosa
 Azul cinzento/rosa palido



568D
 Bleu gris/menthe douce
 Gray blue/sweet mint
 Gris azulado/menta dulce
 Blau grau/süße minze
 Azul cinzento/menta doce

LONGUEUR DE BRANCHES
 Temple length / Largo de varillas
 Bugellänge / Tamanho das hastas
 ✓ 120 mm ✓ 130 mm

PONTS EUROPE ✓
 European bridge
 Puente europeo
 Europäischer Nasensteg
 Ponte Europa

PONTS "P" ASIE ✓
 Asian bridge
 Puente asiático
 Asiatischer Nasensteg
 Ponte Asia

✓ *Standard – Standard – Estándar – Standard – Tipo*
 ✓ *Disponibile – Available – Disponible – Verfügar – Disponível*

JUNIOR HYBRID-3 CJ29



570B

Gris foncé/rouge
Dark gray/red
Gris oscuro/rojo
Dunkelgrau/rot
Cinzeno escuro/vermelho

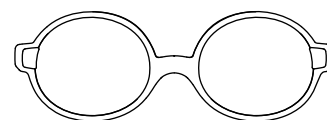

A	B	ED	N
43	37	44	16



380C

Bleu vert/bleu vert
Blue green/blue green
Azul verdosa/azul verdoso
Petrol/petrol
Azul verdeado/azul verdeado

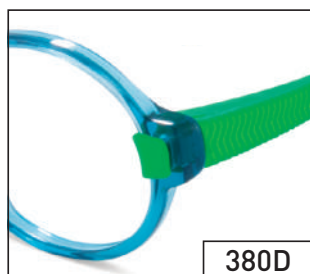

380D

Bleu vert/vert vif
Blue green/bright green
Azul verdosa/verde vivo
Petrol/apfelgrün
Azul verdeado/verde vivo



380E

Bleu vert/fuchsia
Blue green/fuchsia
Azul verdosa/fucsia
Petrol/fucsia
Azul verdeado/fúcsia



380F

Bleu vert/menthe douce
Blue green/sweet mint
Azul verdosa/menta dulce
Petrol/süße minze
Azul verdeado/menta doce



569D

Magenta/rose poudré
Magenta/powder pink
Magenta/rosa palido
Magenta/altrosa
Magenta/rosa palido



569E

Magenta/lie de vin
Magenta/wine
Magenta/poso de vino
Magenta/weinrot
Magenta/bordô



570A

Gris foncé/jaune
Dark gray/yellow
Gris oscuro/amarillo
Dunkelgrau/gelb
Cinzeno escuro/amarelo



570C

Gris foncé/vert vif
Dark gray/bright green
Gris oscuro/verde vivo
Dunkelgrau/apfelgrün
Cinzeno escuro/verde vivo

LONGUEUR DE BRANCHES

Temple length / Largo de varillas
Bugellänge / Tamanho das hastas

✓ 120 mm ✓ 130 mm

PONTS EUROPE

European bridge
Puente europeo ✓
Europäischer Nasensteg
Ponte Europa

PONTS "P" ASIE

Asian bridge
Puente asiático ✓
Asiatischer Nasensteg
Ponte Asia

✓ Standard – Standard – Estándar – Standard – Tipo
✓ Disponible – Available – Disponibile – Verfügbar – Disponível

JUNIOR HYBRID-3 CJ32



A	B	ED	N
43	35	45	15



586A

Vert amande/menthe douce
Almond green/sweet mint
Verde almendra/menta dulce
Mandelgrün/süße minze
Verde amêndoa/menta doce



586B

Vert amande/lie de vin
Almond green/wine
Verde almendra/poso de vino
Mandelgrün/weinrot
Verde amêndoa/bordô



587A

Framboise/pêche
Raspberry/peach
Frambuesa/melocotón
Himbeere/pfirsich
Framboesa/pêssego



587B

Framboise/fuchsia
Raspberry/fuchsia
Frambuesa/fucsia
Himbeere/fucsia
Framboesa/fúcsia



588A

Lavande/rose poudré
Lavender/powder pink
Lavanda/rosa palido
Lavendel/altrosa
Lavanda/rosa palido



588B

Lavande/fuchsia
Lavender/fucsia
Lavanda/fucsia
Lavendel/fucsia
Lavanda/fúcsia

LONGUEUR DE BRANCHES

Temple length / Largo de varillas
Bugellänge / Tamanho das hastas

✓ 120 mm ✓ 130 mm

PONTS EUROPE

European bridge
Puente europeo ✓
Europäischer Nasensteg
Ponte Europa

PONTS "P" ASIE

Asian bridge
Puente asiático ✓
Asiatischer Nasensteg
Ponte Asia

✓ Standard – Standard – Estándar – Standard – Tipo

✓ Disponible – Available – Disponibile – Verfügar – Disponível

JUNIOR HYBRID-3 CJ33



591C

Vieux rose/pêche
Old rose/peach
Rosa viejo/melocotón
Altrosa/pfirsich
Rosa antigo/pêssego

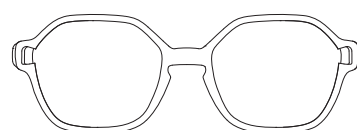

A	B	ED	N
44	37	47	15



589A

Kaki/lie de vin
Kahki/wine
Caqui/poso de vino
Kaki/weinrot
Caqui/bordó



589B

Kaki/menthe douce
Kahki/sweet mint
Caqui/menta dulce
Kaki/süße minze
Caqui/menta doce



589C

Kaki/jaune
Kahki/yellow
Caqui/amarillo
Kaki/gelb
Caqui/amarelo



590A

Bleu denim/rose poudré
Denim blue/powder pink
Azul denim/rosa palido
Denimblau/altrosa
Azul denim/rosa palido

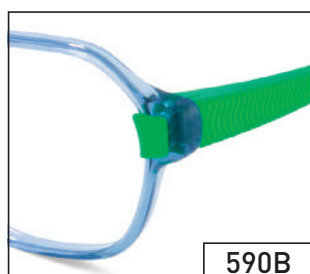

590B

Bleu denim/vert vif
Denim blue/bright green
Azul denim /verde vivo
Denimblau/Apfelgrün
Azul denim /verde vivo



590C

Bleu denim/bleu roi
Denim blue/blue
Azul denim/azul
Denimblau/königsblau
Azul denim/azul real



591A

Vieux rose/lie de vin
Old rose/wine
Rosa viejo/poso de vino
Altrosa/weinrot
Rosa antigo/bordó



591B

Vieux rose/rose poudré
Old rose/powder pink
Rosa viejo/rosa palido
Altrosa/altrosa
Rosa antigo/rosa palido

LONGUEUR DE BRANCHES

Temple length / Largo de varillas
Bugellänge / Tamanho das hastas

✓ 120 mm ✓ 130 mm

PONTS EUROPE

European bridge
Puente europeo
Europäischer Nasensteg
Ponte Europa

PONTS "P" ASIE

Asian bridge
Puente asiático
Asiatischer Nasensteg
Ponte Ásia



✓ Standard – Standard – Estándar – Standard – Tipo
✓ Disponible – Available – Disponível – Verfügbar – Disponivel

GAINES/MANCHONS







GAINES / SLEEVES BB - JUNIOR - JUNIOR HYBRID-1 & 2

 Bleu vert - Blue green - Azul verdoso - Petrol Azul verdeado 03	 Blanc - White - Blanco - Weiß - Branco 15	 Anis - Acid green - Anís - Anis - Anis 22
 Gris - Gray - Gris - Grau - Cinzento 05	 Rouge vif - Bright red - Rojo vivo - Grell rot Vermelho vivo 16	 Violet - Purple - Violeta - Lila - Violeta 23
 Noir - Black - Negro - Schwarz - Preto 06	 Parme - Parma - Parma - Parma - Parma 17	 Bleu marine - Navy - Azul marinho - Marine Azul marinho 25
 Prune - Plum - Ciruela - Lila - Roxo 08	 Aqua - Aqua - Aqua - Wasserblau - Aqua 18	 Orange foncé - Dark orange - Naranja oscuro Dunkel orange - Laranja escuro 26
 Rose - Rose - Rosa - Rosa - Rosa 10	 Fuchsia - Fuchsia - Fucsia - Fuchsia - Fuchsia 20	 Rouge cerise - Cherry red - Cereza - kirsch rot Cereza 27
 Kaki - Kahki - Caqui - Kaki - Caqui 11	 Bleu foncé - Dark blue - Azul oscuro Dunkelblau - Azul escuro 21	 Bleu givré - Frosted blue - Azul escarchado Blau gefrostet - Azul gelo 29
 Jaune - Yellow - Amarillo - Gelb - Amarelo 13		

GAINES / SLEEVES JUNIOR HYBRID-2 CJ16 & CJ19 (mini gaines)

 Prune - Plum - Ciruela - Lila - Roxo MG08	 Rouge vif - Bright red - Rojo vivo - Grell rot Vermelho vivo MG16	 Bleu marine - Navy - Azul marinho - Marine Azul marinho MG25
---	---	---

MANCHONS / END TIP JUNIOR - JUNIOR HYBRID-1

 Noir - Black - Negro Schwarz - Preto 01	 Orange - Orange - Naranja Orange - Laranja 05	 Rouge - Red - Rojo Rot - Vermelho 08	 Prune - Plum - Ciruela Lila - Roxo 03
 Bleu - Blue - Azul Blau - Azul 04	 Gris - Gray - Gris Grau - Cinzento 07	 Bleu marine - Navy Azul marinho - Marine - Azul marinho 11	 Marron - Brown - Marrón Braun - Castanho 10

MANCHONS / END TIP JUNIOR HYBRID-2

 Gris - Gray - Gris Grau - Cinzento E7	 Noir - Black - Negro Schwarz - Preto E1	 Prune - Plum - Ciruela Lila - Roxo E3	 Bleu vert - Blue green - Azul verdoso Petrol - Azul verdeado E12
 Bleu marine - Navy Azul marinho - Marine - Azul marinho E11	 Marron - Brown - Marrón Braun - Castanho E10	 Orange - Orange - Naranja Orange - Laranja E5	 Rouge - Red - Rojo Rot - Vermelho E8

MANCHONS / END TIP JUNIOR HYBRID-2 (mini gaines)

 Noir - Black - Negro Schwarz - Preto EM1

COLLECTION "BB"



BB HYBRID-1 CB1

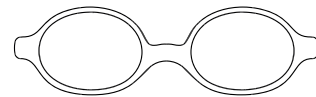

A	B	ED	N
38	29	39	16



540A

Parme brillant/parme
Shiny parma/parma
Parma brillante/parma
Parma glänzend/parma
Parma brilhante/parma



540B

Parme brillant/prune
Shiny parma/plum
Parma brillante/ciruela
Parma glänzend/lila
Parma brilhante/roxo



541B

Gris brillant/rouge cerise
Shiny gray/cherry red
Gris brillante/cereza
Grau glänzend/kirsch rot
Cinzeno brilhante/cereza



542B

Bleu brillant/bleu foncé
Shiny blue/dark blue
Azul brillante/azul oscuro
Blau glänzend/dunkelblau
Azul brilhante/azul escuro



543A

Rose brillant/rose
Shiny rose/rose
Rosa brillante/rosa
Rosa glänzend/rosa
Rosa brilhante/rosa



543B

Rose brillant/fuchsia
Shiny rose/fuchsia
Rosa brillante/fucsia
Rosa glänzend/fucsia
Rosa brilhante/fucsia

LONGUEUR DE BRANCHES

Temple length / Largo de varillas
Bugellänge / Tamanho das hastas 95 mm



<https://www.facebook.com/minima.lunettes/>



https://www.instagram.com/minima_eyewear/



<https://www.linkedin.com/company/minima-eyewear/mycompany/>

FRANCE

Minima SAS
4, avenue Delage – 91310 Linas
Tél.: 01 69 01 03 03 commande@minima.fr

Export

Tél.: +33 1 64 49 84 39

DEUTSCHLAND

Minima GmbH
Lilienthalstr.8 – 10965 Berlin
Tel. 030-69817594
Fax. 030-69817596
deutschland@minima.fr

BELGIQUE

Minima SAS
Numéro vert: 080074926
export@minima.fr

CANADA

Minima SAS
Tél.: +33 1 64 49 84 39
export@minima.fr



www.minima.fr