

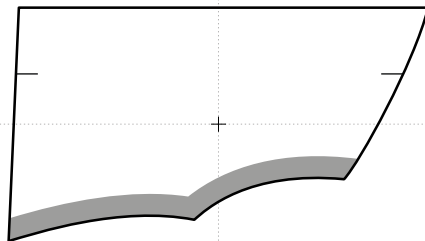

ateliér
kreativ

ADAM



3,5 mm

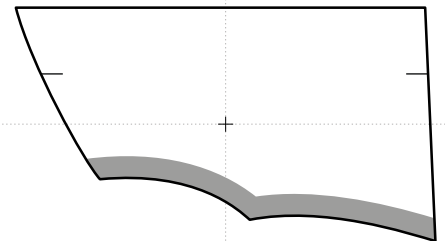

ADELA

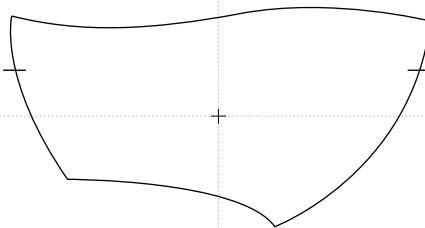

1,5 mm

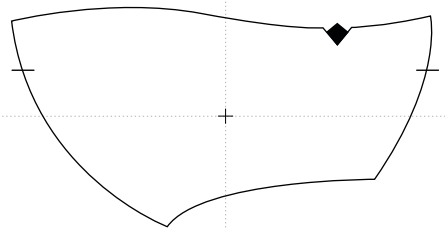

ADINA

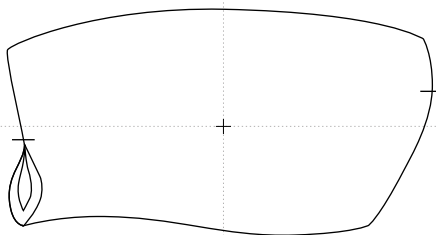

0 mm

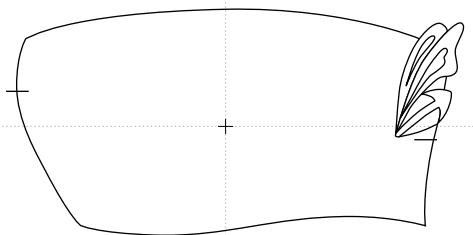

ADRIANA

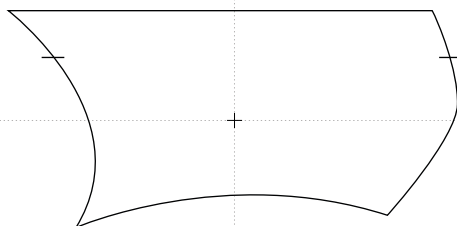

1 mm

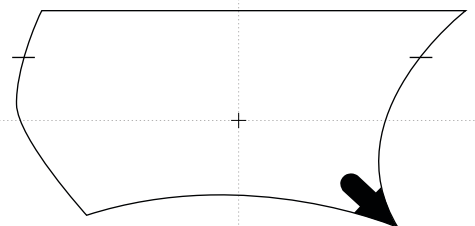

Tyto kreativní tvary brýlových čoček byly navrženy a vyrobeny v ateliéru kreativ při společnosti EYE 2000 s.r.o. a jsou chráněny Úřadem průmyslového vlastnictví jako průmyslový vzor.
These creative glasses lens shapes were designed and produced by ateliér kreativ by EYE 2000 s.r.o. company and are patented and protected by the Authority of the Industrial Property.

EYE 2000 s.r.o. / Ohmova 271 / 109 00 Praha 10 / Czech Republic / Provozovna / Polubenská 614 / 468 61 Desná / Czech Republic
T +420 271 961 170 / www.eye2000.cz / info@eye2000.cz



ateliér
kreativ

AGATA

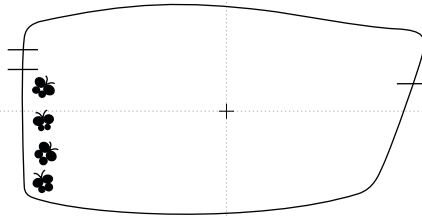

1,5 mm

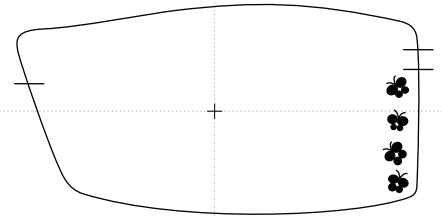

AGNES

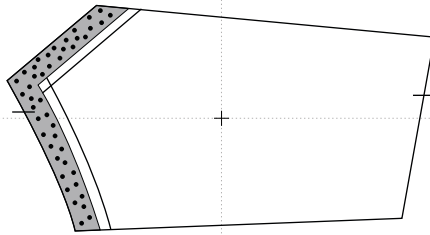

1,5 mm

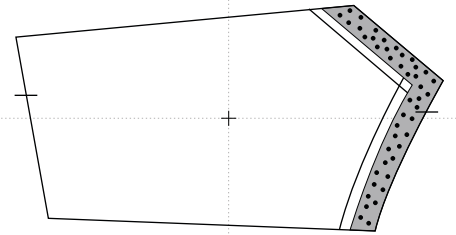

ALBERT

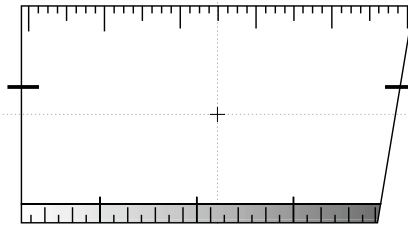

1,7 mm

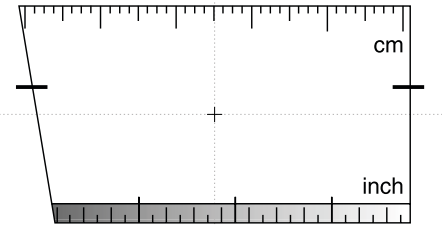

ALENKA

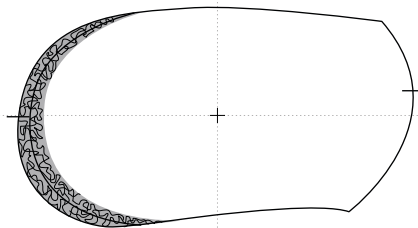

0 mm

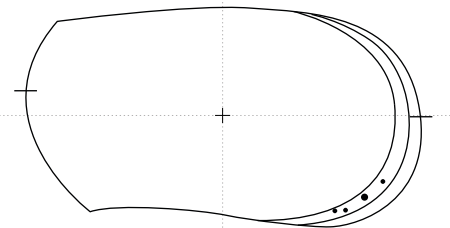

Tyto kreativní tvary brýlových čoček byly navrženy a vyrobeny v ateliéru kreativ při společnosti EYE 2000 s.r.o. a jsou chráněny Úřadem průmyslového vlastnictví jako průmyslový vzor. These creative glasses lens shapes were designed and produced by ateliér kreativ by EYE 2000 s.r.o. company and are patented and protected by the Authority of the Industrial Property.

EYE 2000 s.r.o. / Ohmova 271 / 109 00 Praha 10 / Czech Republic / Provozovna / Polubenská 614 / 468 61 Desná / Czech Republic
T +420 271 961 170 / www.eyeye2000.cz / info@eyeye2000.cz

ALES

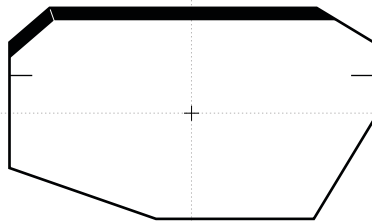

0 mm

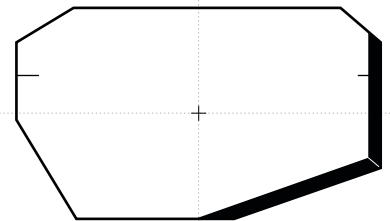

ALEX

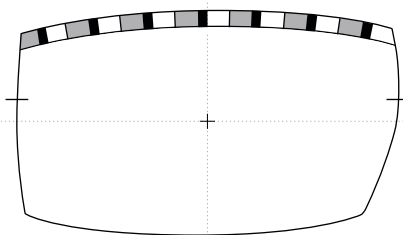

0 mm

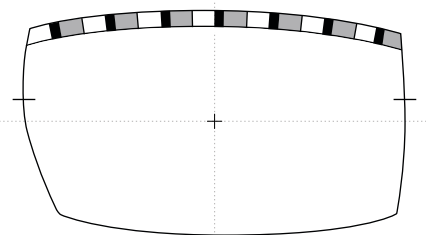

ALEXANDRA

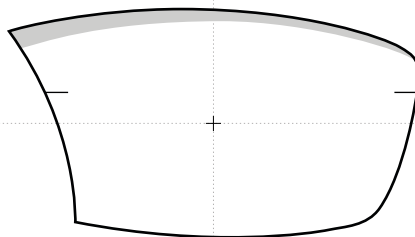

0,5 mm

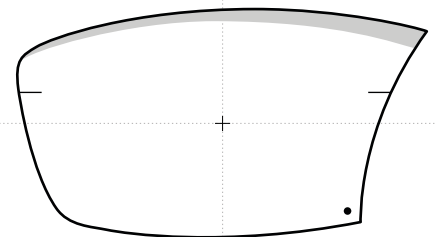

AMALKA

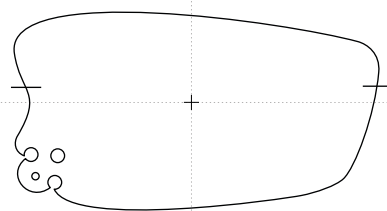

0,5 mm

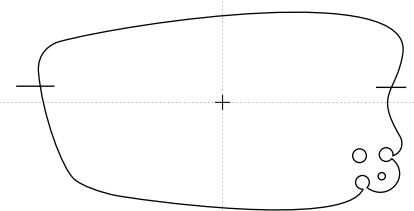



atelier
kreativ

AMELIE

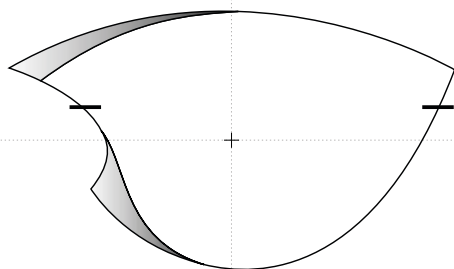

2,2 mm

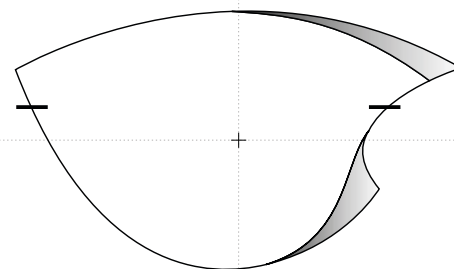

ANDREA

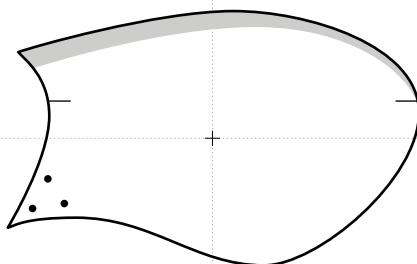

0,5 mm

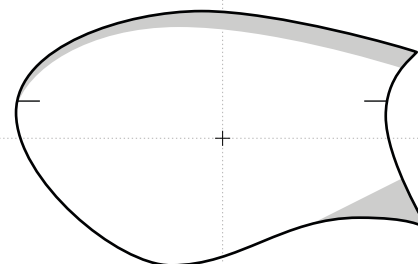

ANDREJ

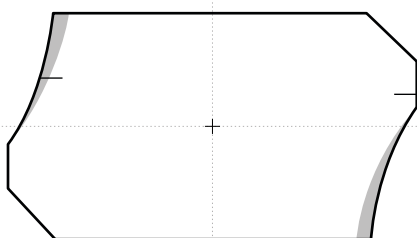

0 mm

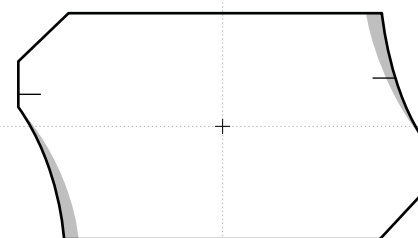

ANEZKA I.

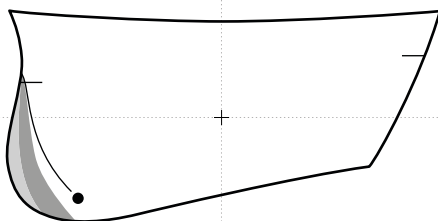

2,5 mm

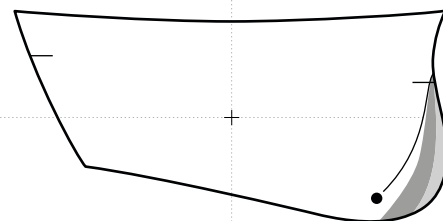

Tyto kreativní tvary brýlových čoček byly navrženy a vyrobeny v ateliéru kreativ při společnosti EYE 2000 s.r.o. a jsou chráněny Úřadem průmyslového vlastnictví jako průmyslový vzor. These creative glasses lens shapes were designed and produced by atelier kreativ by EYE 2000 s.r.o. company and are patented and protected by the Authority of the Industrial Property.

EYE 2000 s.r.o. / Ohmova 271 / 109 00 Praha 10 / Czech Republic / Provozovna / Polubenská 614 / 468 61 Desná / Czech Republic
T +420 271 961 170 / www.eye2000.cz / info@eye2000.cz

ANEZKA II.

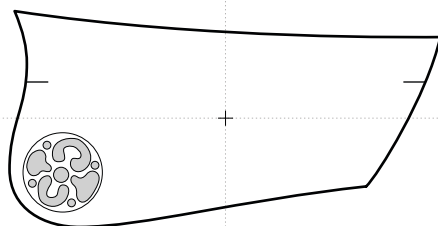

2,5 mm

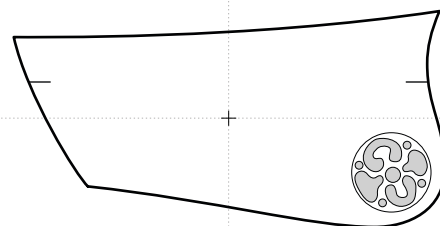

ANITA

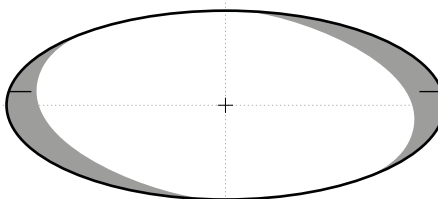

0,5 mm

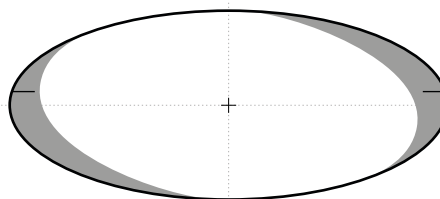

ANNA

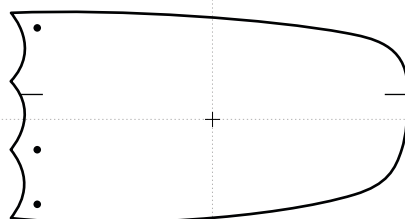

0 mm

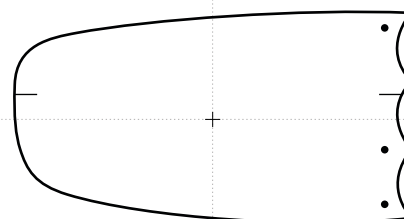

ANNABELA

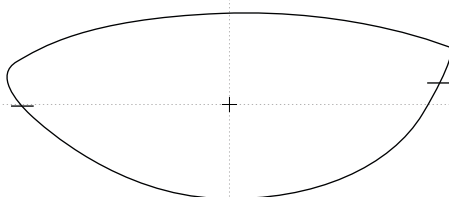

1,6 mm

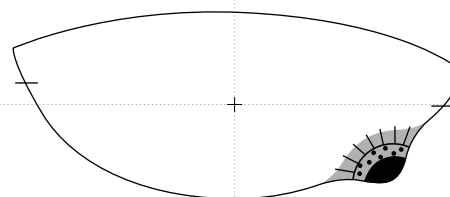

ANNALIZA

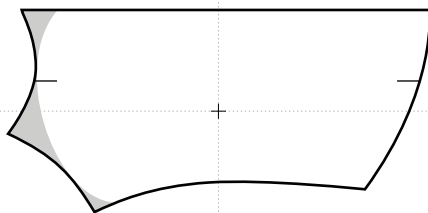

1,5 mm

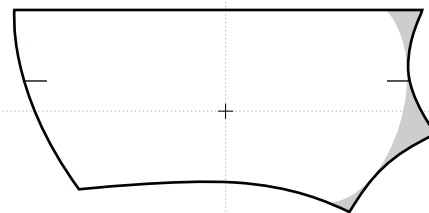

ANTIMONA

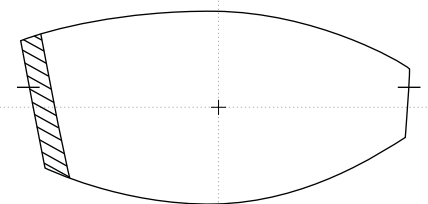

0 mm

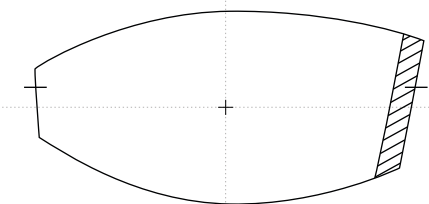

APOLENA

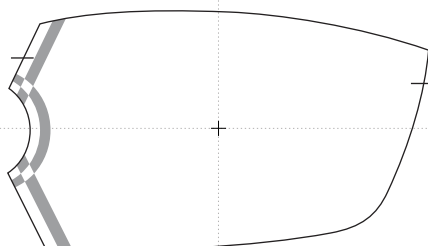

1 mm

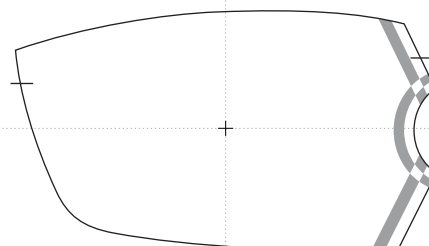

ARIEL

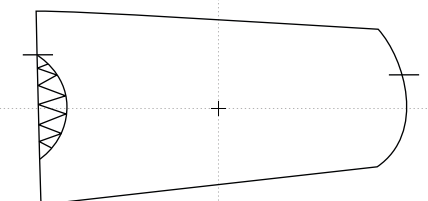

0,5 mm

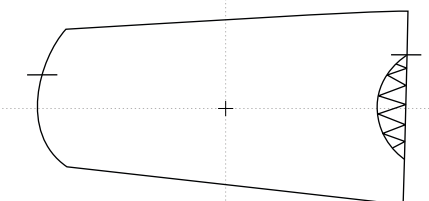

ARJANA

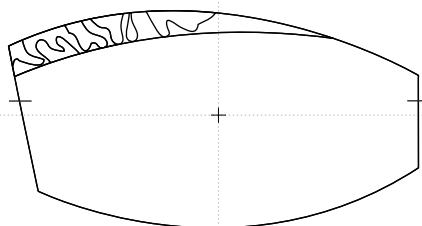

0 mm

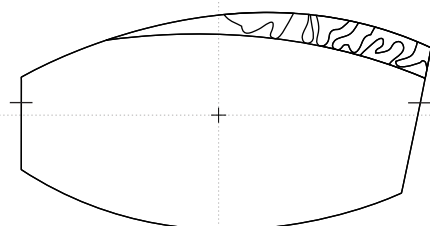

ARSENICA

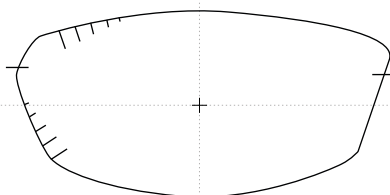

0,5 mm

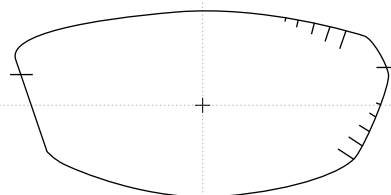

ARTUR

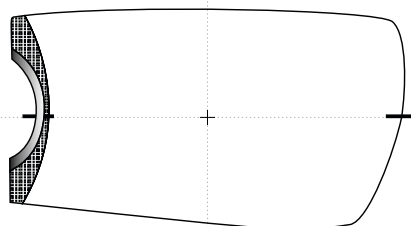

0 mm

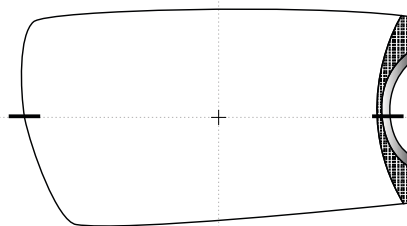

ASTRID

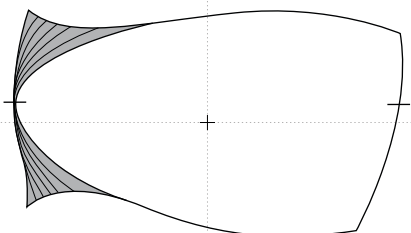

0,6 mm

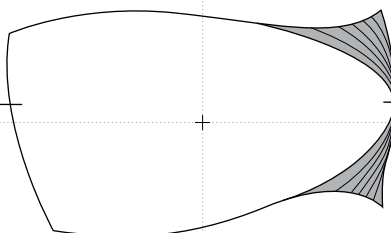

AURA

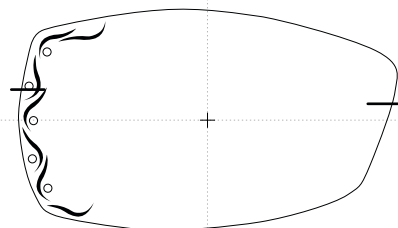

0,7 mm

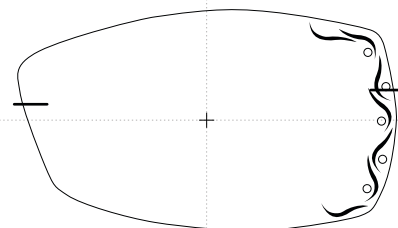

AUREA

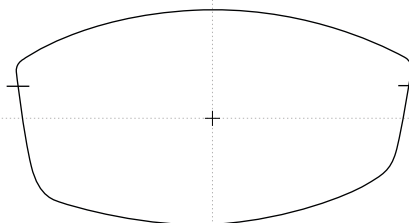

0,5 mm

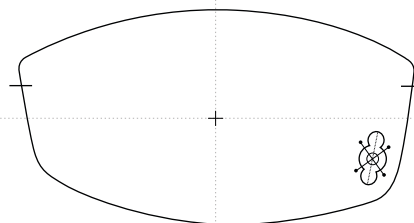

BARBORA

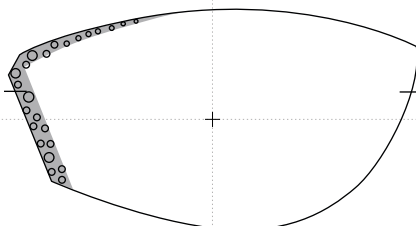

0,9 mm

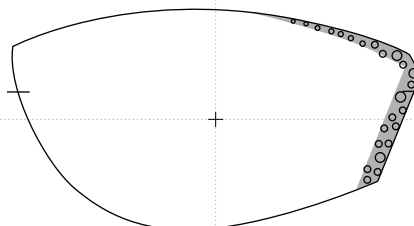

BARIUS

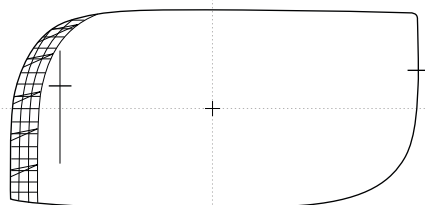

0 mm

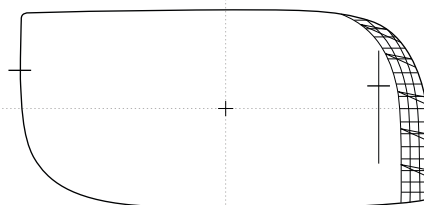

BARUNKA

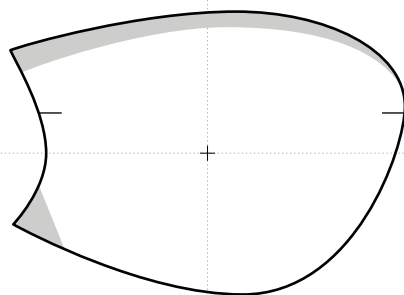

0 mm

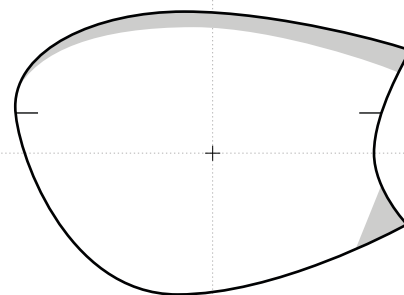

BEATA

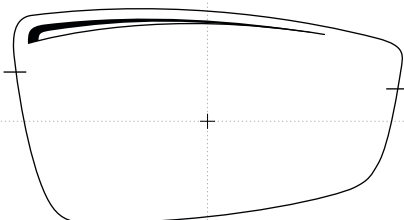

0,5 mm

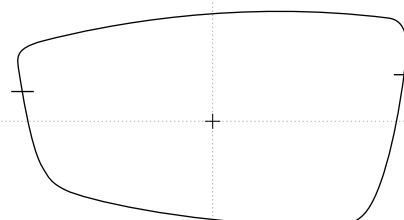

BEATRICE

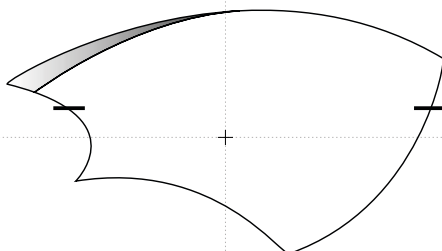

1,8 mm

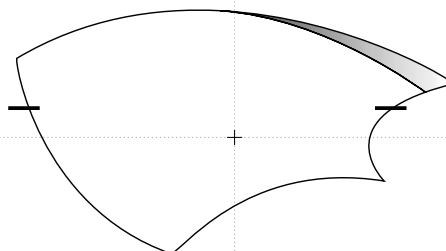

BELA

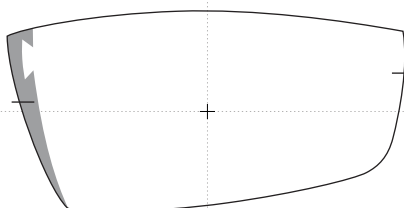

0 mm

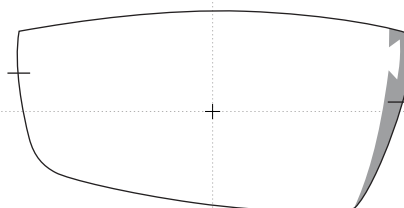

BENEDIKT

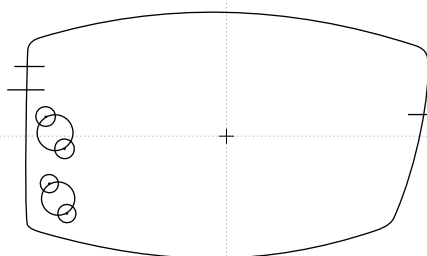

0,5 mm

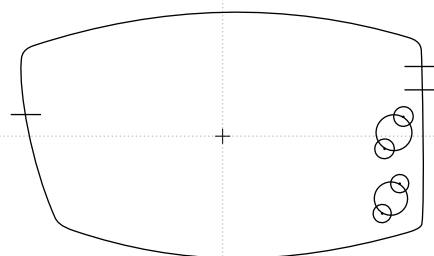

BERAN

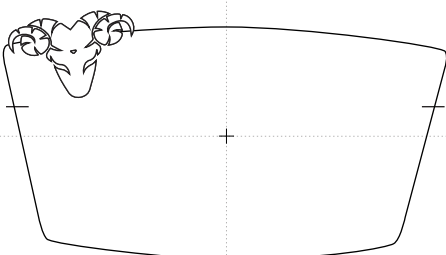

1,5 mm

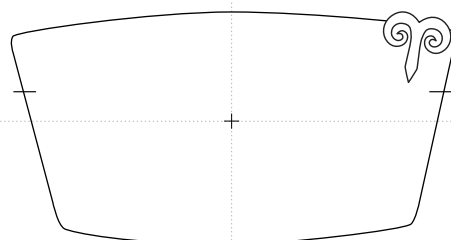

BERENIKA

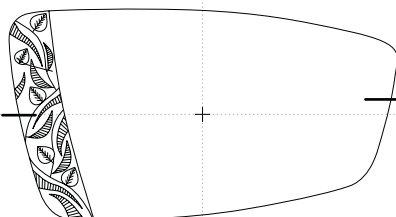

1 mm

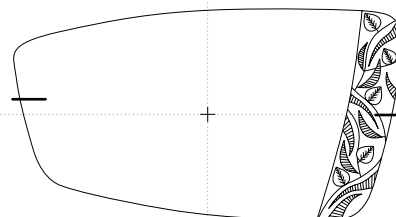

BERYL

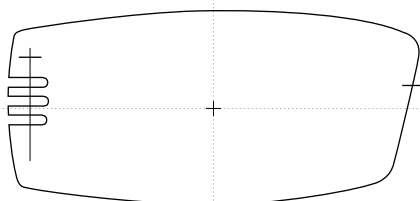

1 mm

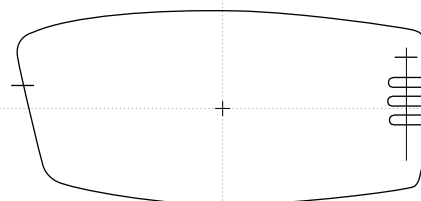

BERTA

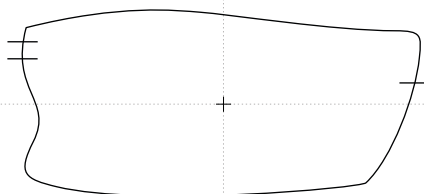

0,5 mm

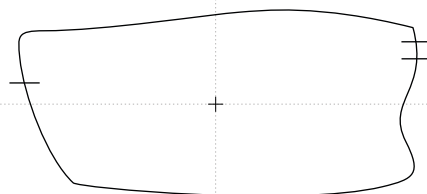

BETYNKA

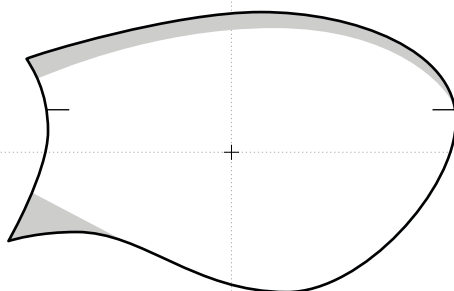

0 mm

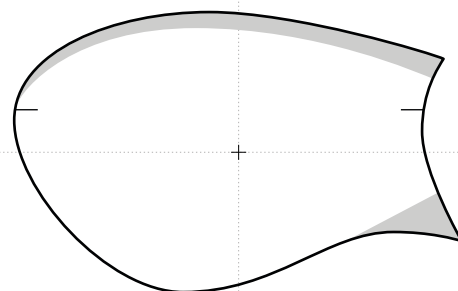

BIANKA

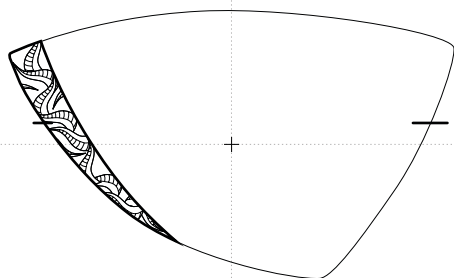

3 mm

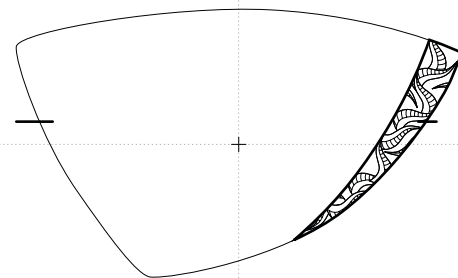

BLANKA

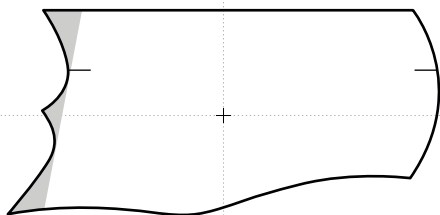

0,5 mm

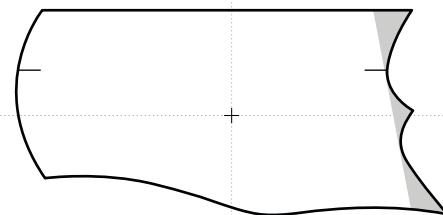

BLEDULE

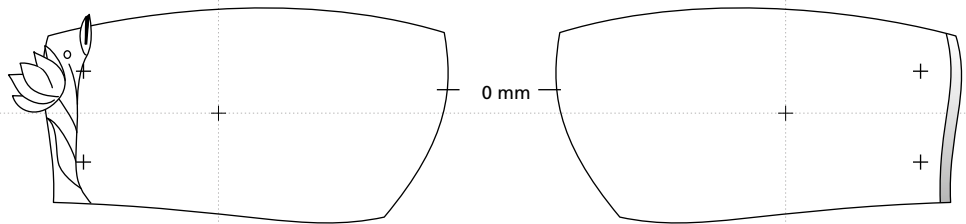

BLIZENCI

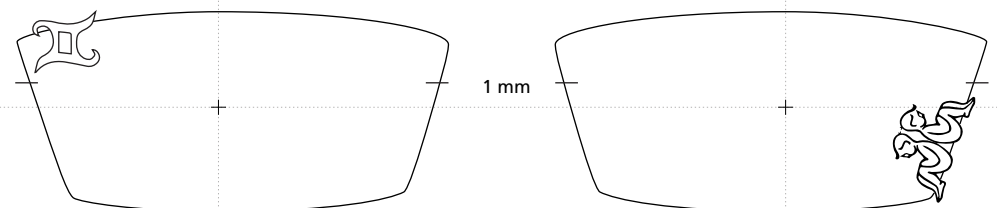

BORA

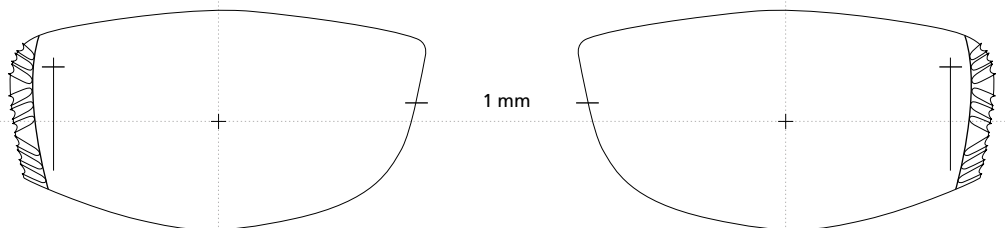

BORIA

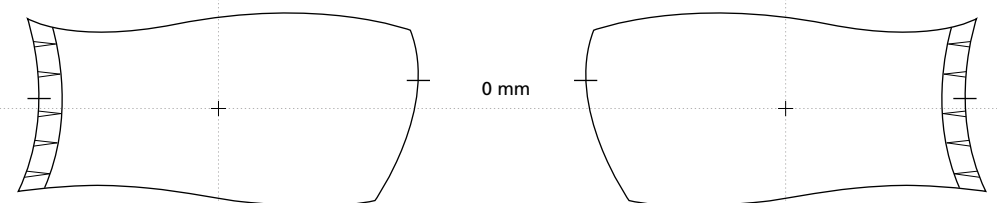



ateliér
kreativ

BOZENKA

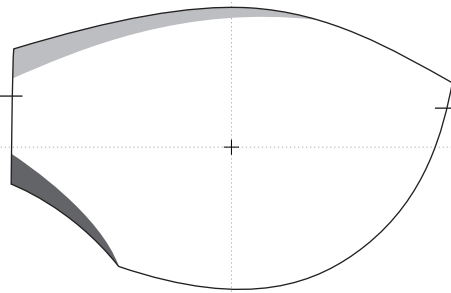

1 mm

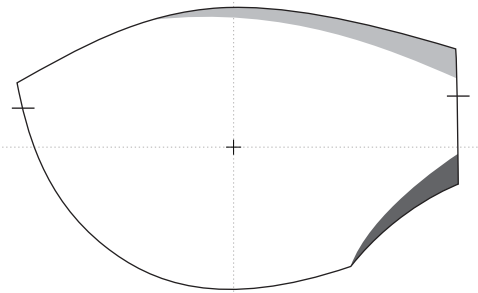

BRENDA

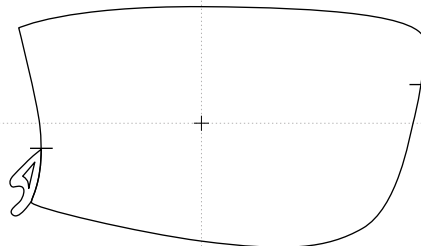

0,5 mm

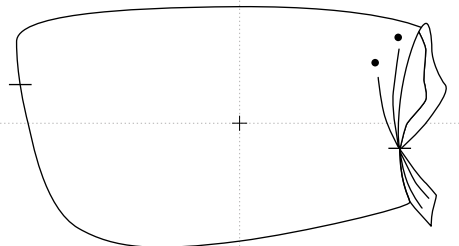

BRIGITA

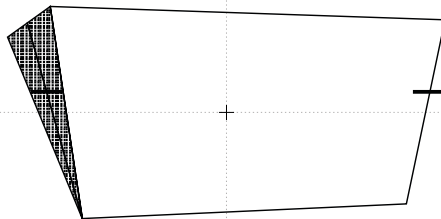

2,2 mm

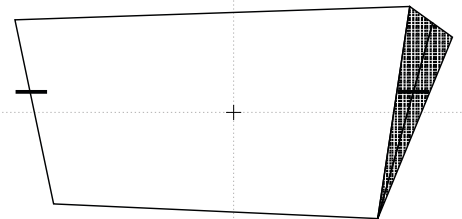

BYK

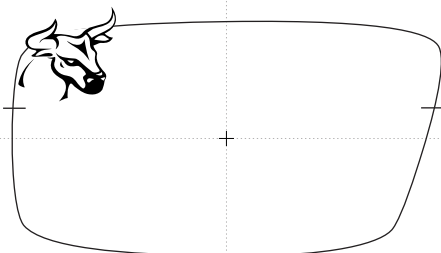

1 mm

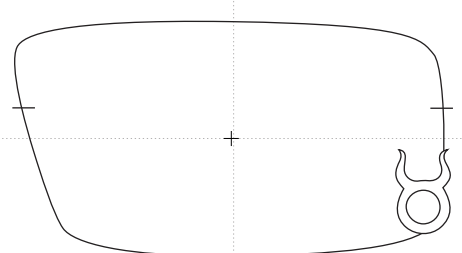

Tyto kreativní tvary brýlových čoček byly navrženy a vyrobeny v ateliéru kreativ při společnosti EYE 2000 s.r.o. a jsou chráněny Úřadem průmyslového vlastnictví jako průmyslový vzor.
These creative glasses lens shapes were designed and produced by ateliér kreativ by EYE 2000 s.r.o. company and are patented and protected by the Authority of the Industrial Property.

EYE 2000 s.r.o. / Ohmova 271 / 109 00 Praha 10 / Czech Republic / Provozovna / Polubenská 614 / 468 61 Desná / Czech Republic
T +420 271 961 170 / www.eye2000.cz / info@eye2000.cz

CAROL

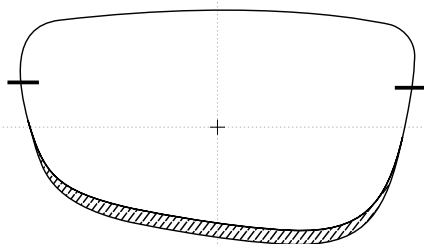

0,5 mm

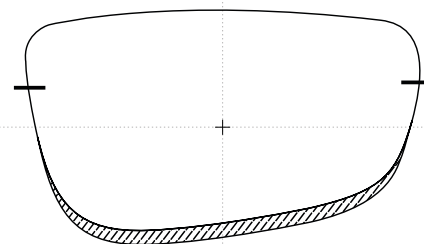

CEZAR

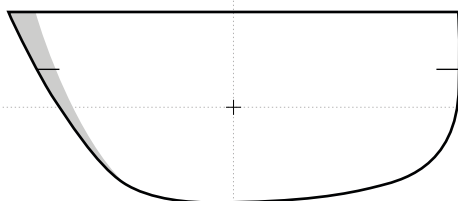

0 mm

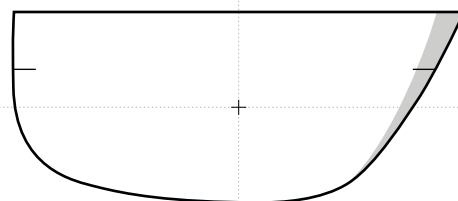

CLAUDIA

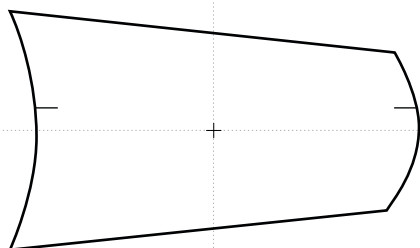

0,5 mm

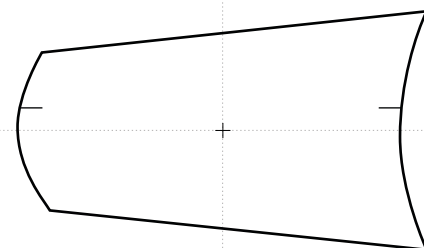

CTIBOR

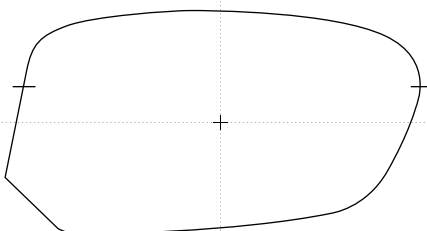

0 mm

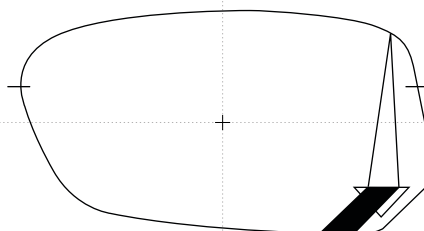



ateliér
kreativ

CUPRIA

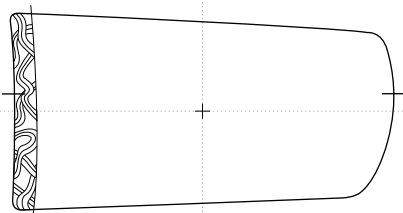

0 mm

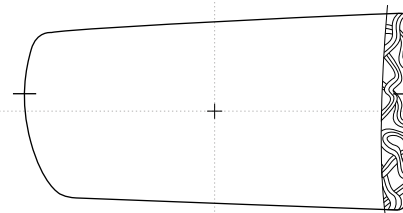

CYNTIE

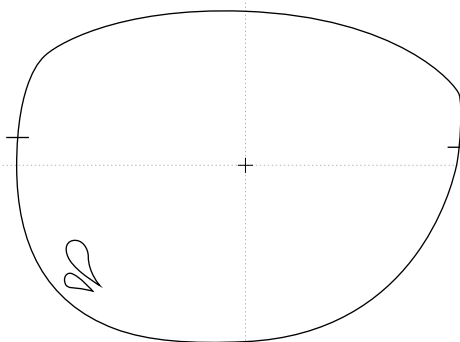

0 mm

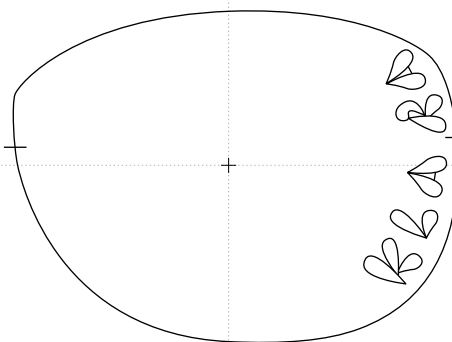

DAGMAR

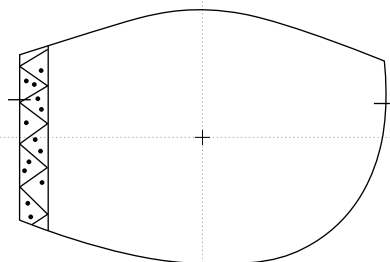

0 mm

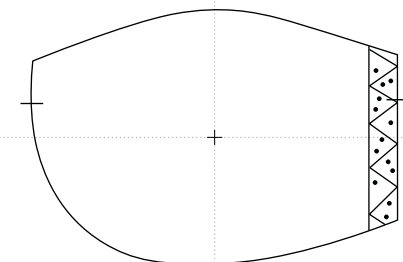

DANICA

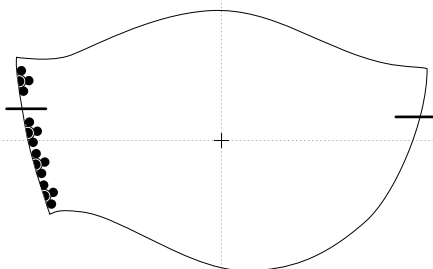

1 mm

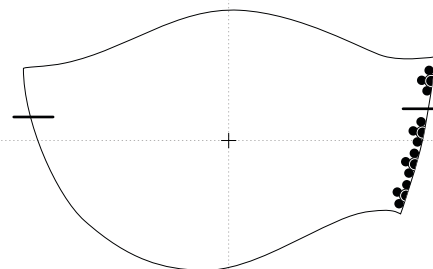

Tyto kreativní tvary brýlových čoček byly navrženy a vyrobeny v ateliéru kreativ při společnosti EYE 2000 s.r.o. a jsou chráněny Úřadem průmyslového vlastnictví jako průmyslový vzor. These creative glasses lens shapes were designed and produced by ateliér kreativ by EYE 2000 s.r.o. company and are patented and protected by the Authority of the Industrial Property.

EYE 2000 s.r.o. / Ohmova 271 / 109 00 Praha 10 / Czech Republic / Provozovna / Polubenská 614 / 468 61 Desná / Czech Republic
T +420 271 961 170 / www.eye2000.cz / info@eye2000.cz

DAPHNE

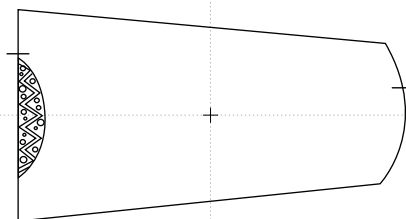

0,5 mm

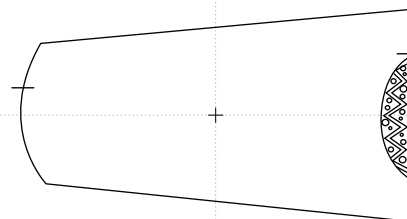

DARA

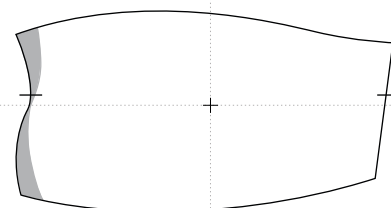

1 mm

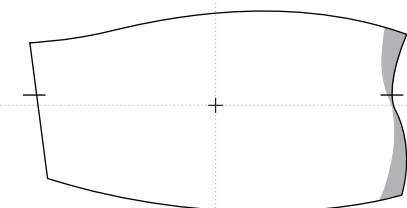

DARINA

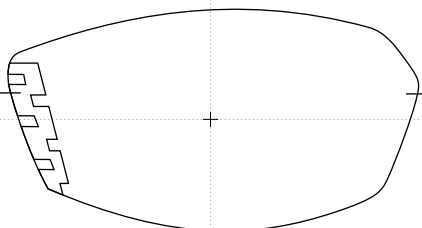

0 mm

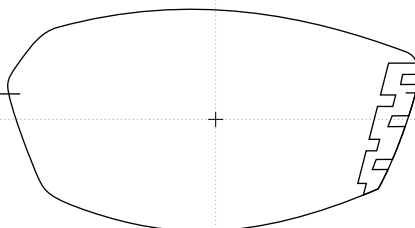

DARJA

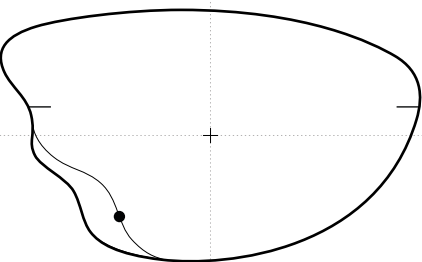

0 mm

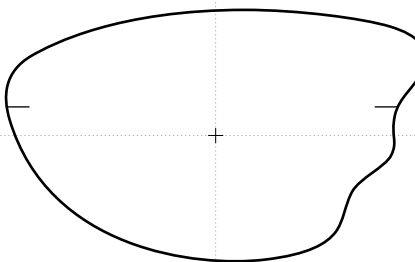



ateliér
kreativ

DAVID

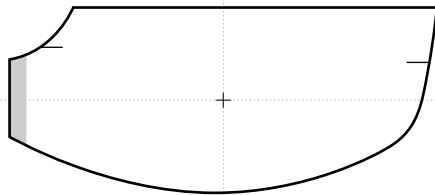

1 mm

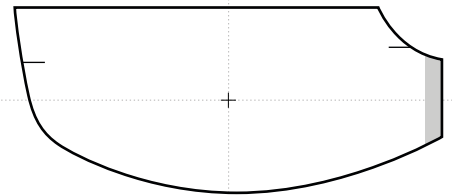

DEBORA

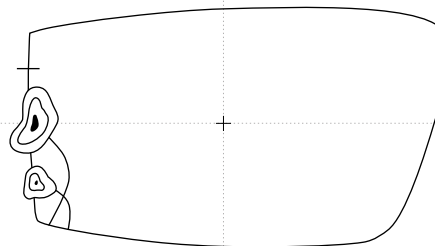

0,5 mm

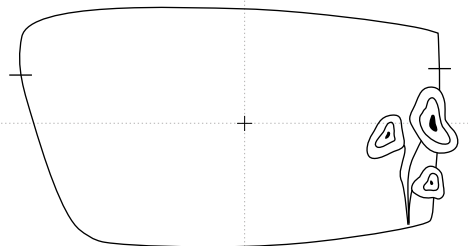

DENISA

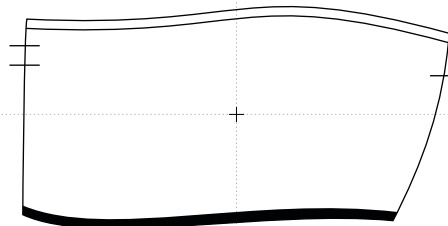

0,5 mm

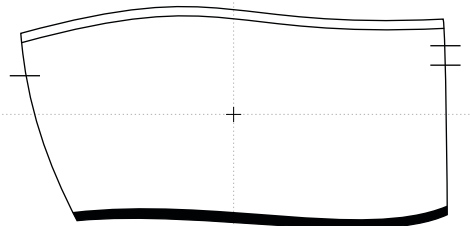

DIANA

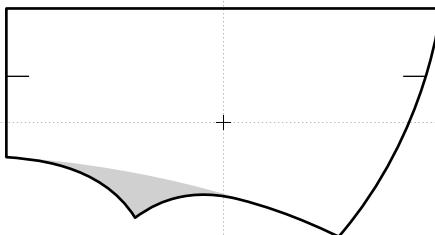

2 mm

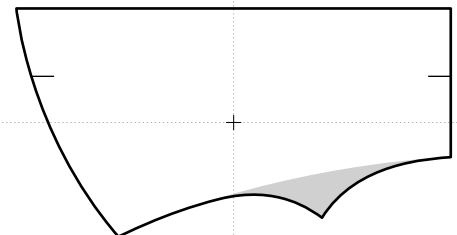

Tyto kreativní tvary brýlových čoček byly navrženy a vyrobeny v ateliéru kreativ při společnosti EYE 2000 s.r.o. a jsou chráněny Úřadem průmyslového vlastnictví jako průmyslový vzor. These creative glasses lens shapes were designed and produced by ateliér kreativ by EYE 2000 s.r.o. company and are patented and protected by the Authority of the Industrial Property.

EYE 2000 s.r.o. / Ohmova 271 / 109 00 Praha 10 / Czech Republic / Provozovna / Polubenská 614 / 468 61 Desná / Czech Republic
T +420 271 961 170 / www.eye2000.cz / info@eye2000.cz

DITA

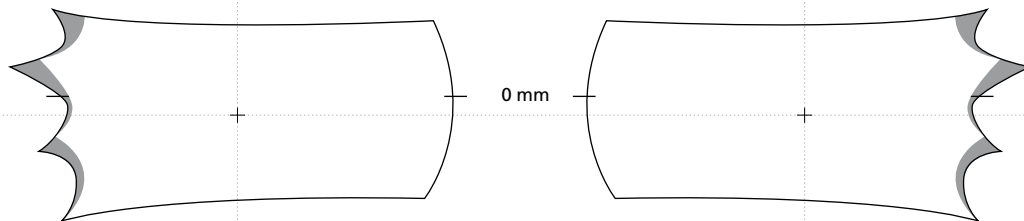

DOBRUSKA

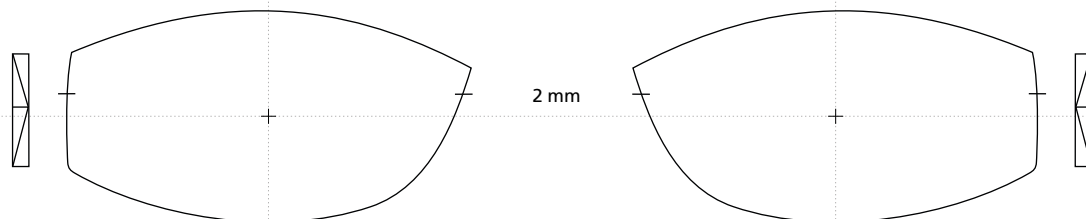

DOMINIKA

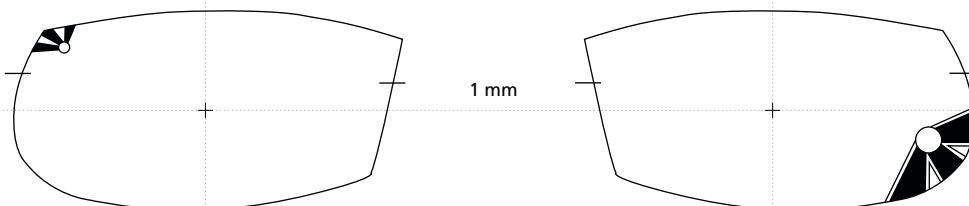

DOROTKA

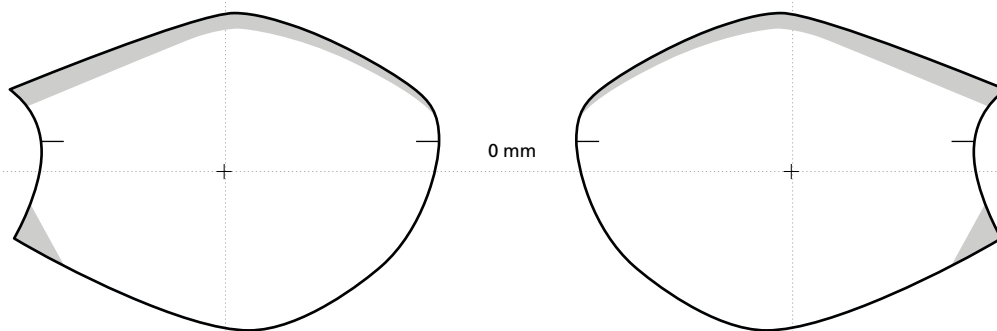



ateliér
kreativ

DRAGANA

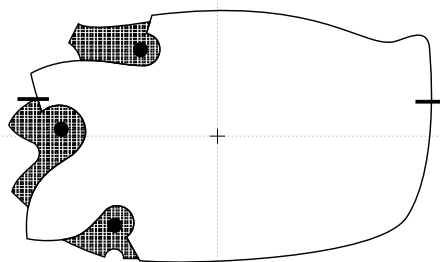

0 mm

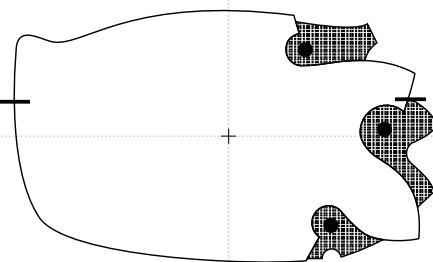

DRAHA

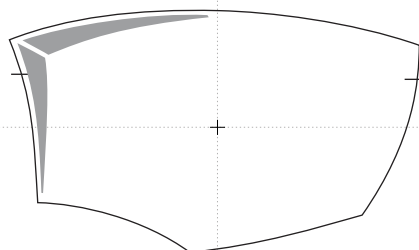

0,25 mm

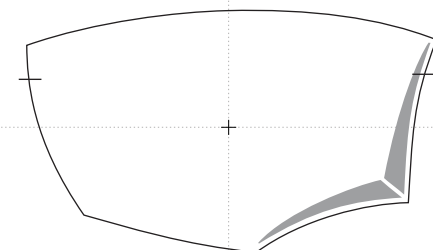

EDITA

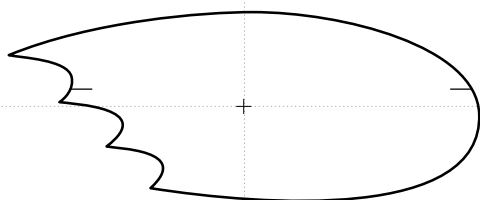

1 mm

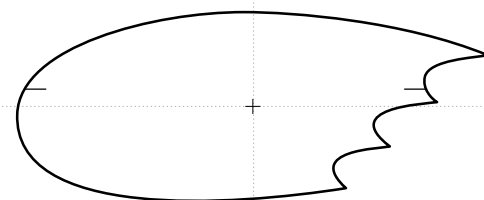

ELEKTRA

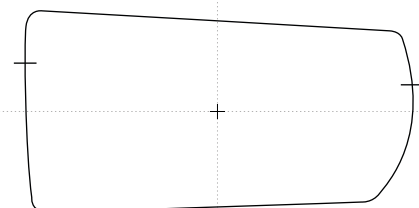

0,5 mm

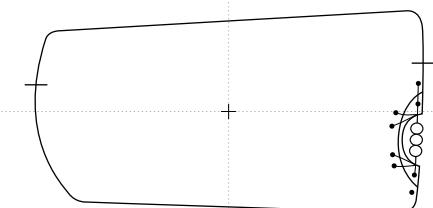

Tyto kreativní tvary brýlových čoček byly navrženy a vyrobeny v ateliéru kreativ při společnosti EYE 2000 s.r.o. a jsou chráněny Úřadem průmyslového vlastnictví jako průmyslový vzor.
These creative glasses lens shapes were designed and produced by ateliér kreativ by EYE 2000 s.r.o. company and are patented and protected by the Authority of the Industrial Property.

EYE 2000 s.r.o. / Ohmova 271 / 109 00 Praha 10 / Czech Republic / Provozovna / Polubenská 614 / 468 61 Desná / Czech Republic
T +420 271 961 170 / www.eye2000.cz / info@eye2000.cz



ateliér
kreativ

ELENA

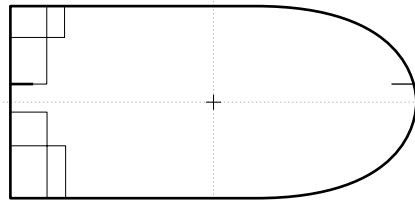

1 mm

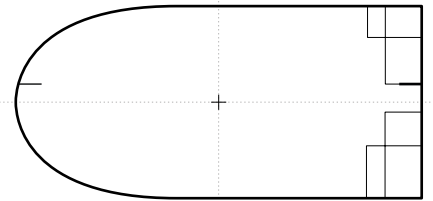

ELISKA

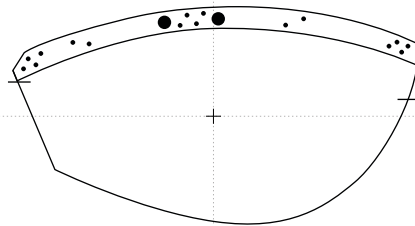

1,4 mm

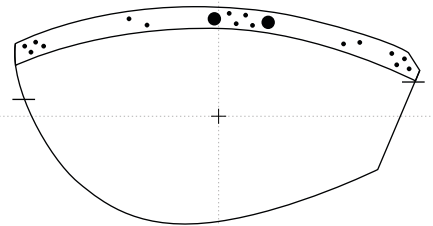

EMANUELA

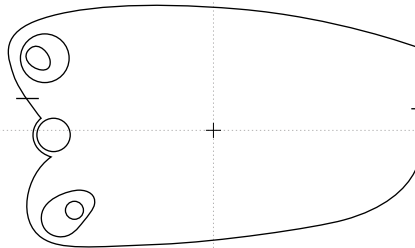

0 mm

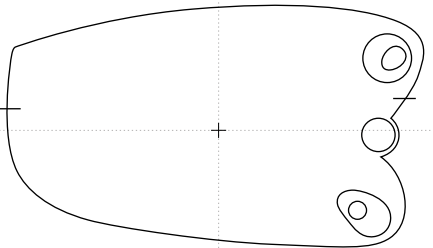

ERBIA

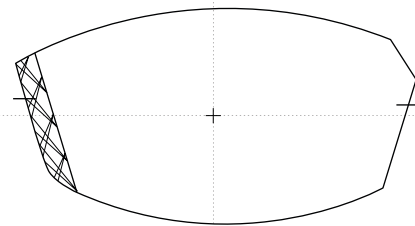

1 mm

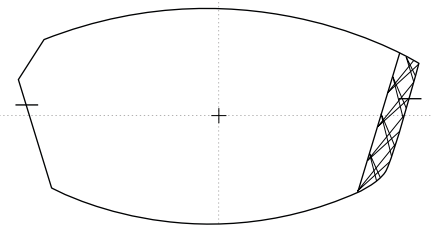

Tyto kreativní tvary brýlových čoček byly navrženy a vyrobeny v ateliéru kreativ při společnosti EYE 2000 s.r.o. a jsou chráněny Úřadem průmyslového vlastnictví jako průmyslový vzor.
These creative glasses lens shapes were designed and produced by ateliér kreativ by EYE 2000 s.r.o. company and are patented and protected by the Authority of the Industrial Property.

EYE 2000 s.r.o. / Ohmova 271 / 109 00 Praha 10 / Czech Republic / Provozovna / Polubenská 614 / 468 61 Desná / Czech Republic
T +420 271 961 170 / www.eye2000.cz / info@eye2000.cz



atelier
kreativ

ERIKA

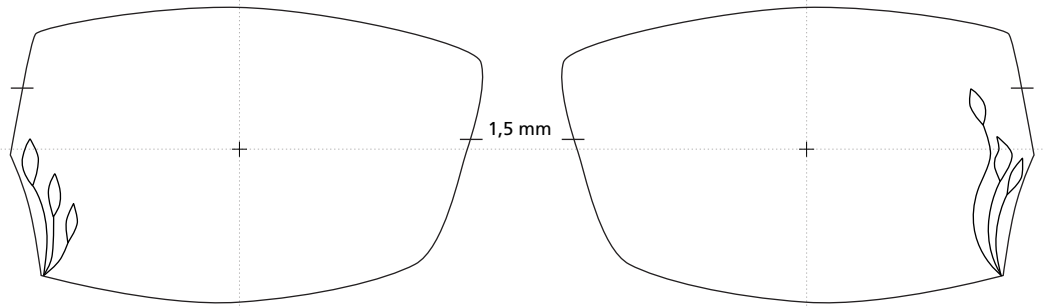

ESET

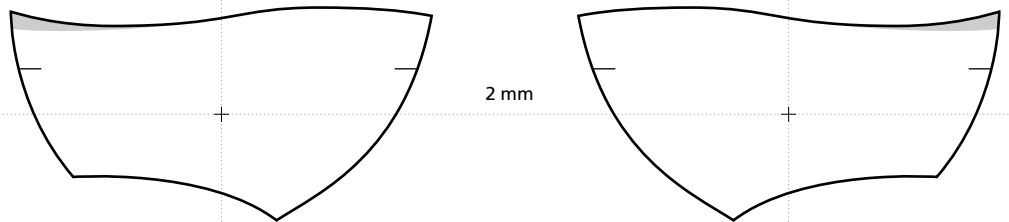

ESTELA

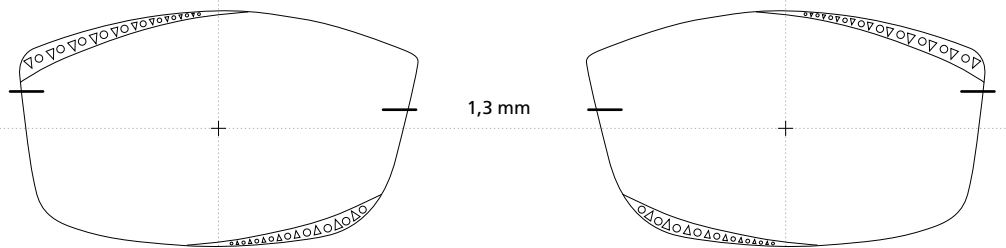

ESTER

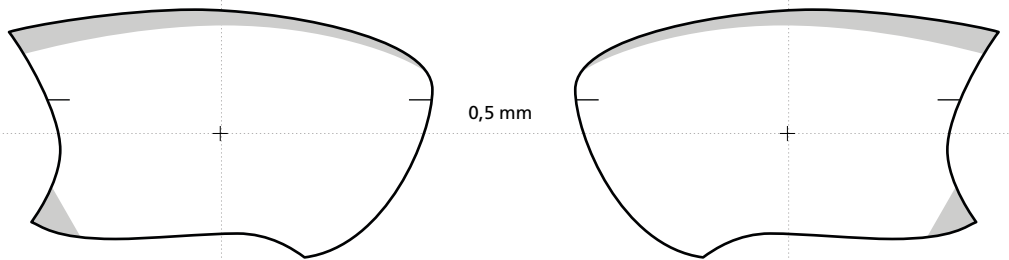

Tyto kreativní tvary brýlových čoček byly navrženy a vyrobeny v ateliéru kreativ při společnosti EYE 2000 s.r.o. a jsou chráněny Úřadem průmyslového vlastnictví jako průmyslový vzor. These creative glasses lens shapes were designed and produced by atelier kreativ by EYE 2000 s.r.o. company and are patented and protected by the Authority of the Industrial Property.

EYE 2000 s.r.o. / Ohmova 271 / 109 00 Praha 10 / Czech Republic / Provozovna / Polubenská 614 / 468 61 Desná / Czech Republic
T +420 271 961 170 / www.eyeye2000.cz / info@eyeye2000.cz

EUFROZINIE

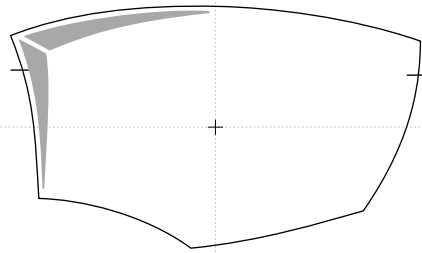

0 mm

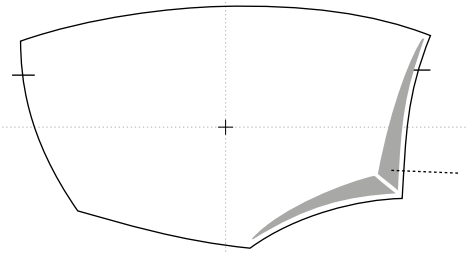

EVA

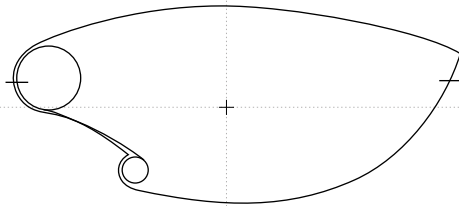

1 mm

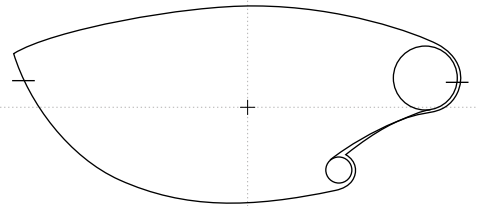

EVELINA

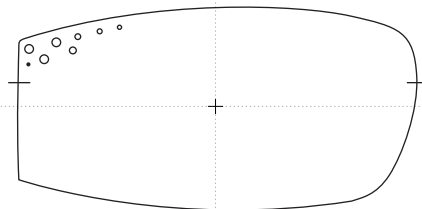

0 mm

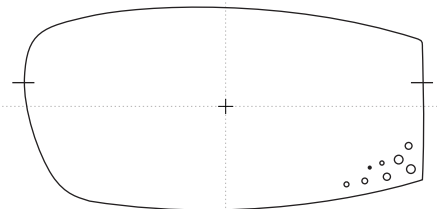

EVZENIE

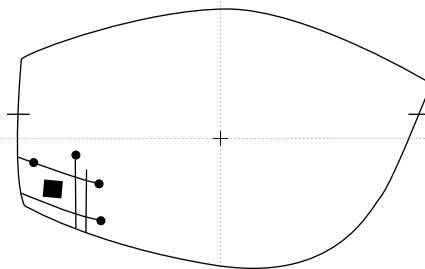

2 mm

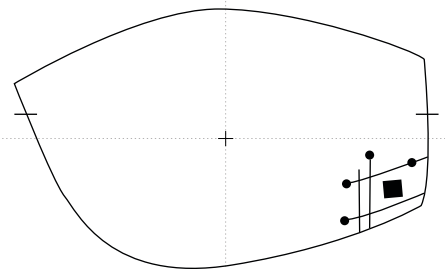



F1008

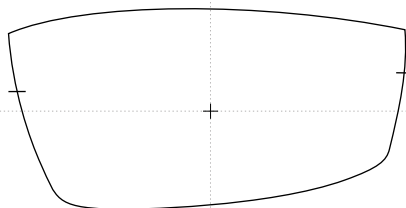

0,5 mm

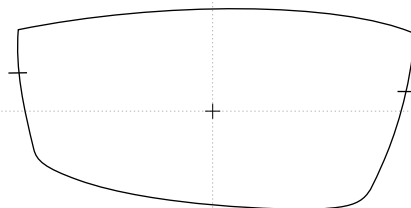

F861+3

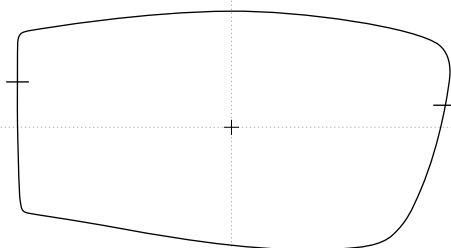

0,5 mm

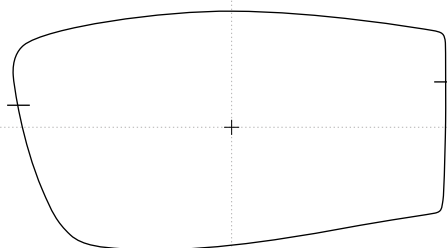

FANYNKA

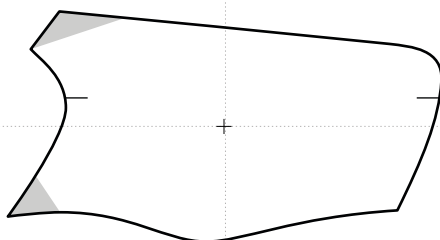

0,5 mm

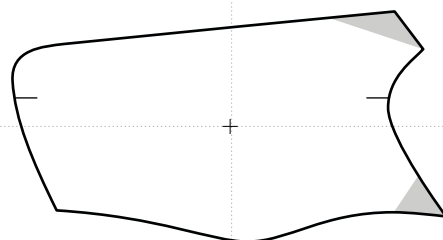

FARIS

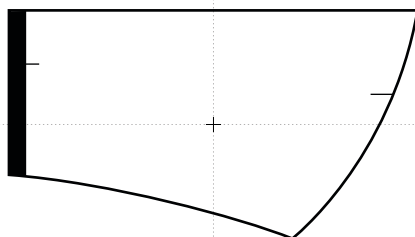

3 mm

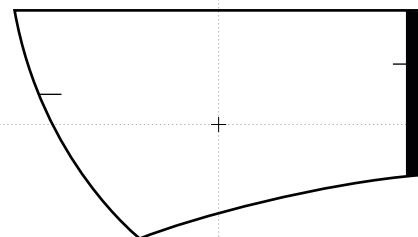

Tyto kreativní tvary brýlových čoček byly navrženy a vyrobeny v ateliéru kreativ při společnosti EYE 2000 s.r.o. a jsou chráněny Úřadem průmyslového vlastnictví jako průmyslový vzor.
These creative glasses lens shapes were designed and produced by atelier kreativ by EYE 2000 s.r.o. company and are patented and protected by the Authority of the Industrial Property.

EYE 2000 s.r.o. / Ohmova 271 / 109 00 Praha 10 / Czech Republic / Provozovna / Polubenská 614 / 468 61 Desná / Czech Republic
T +420 271 961 170 / www.eye2000.cz / info@eye2000.cz

FEDERICO

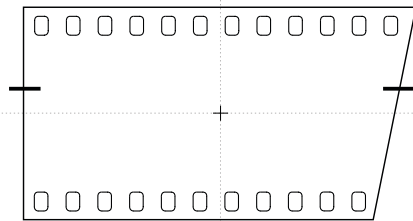

2,3 mm

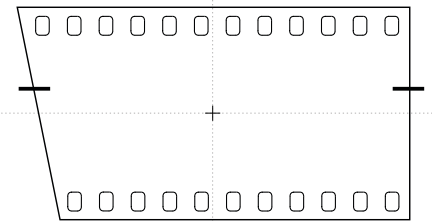

FERARA

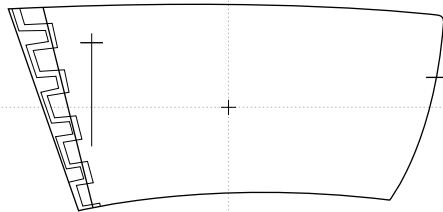

1 mm

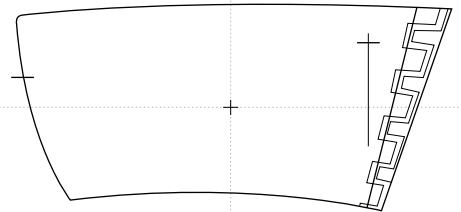

FERDA

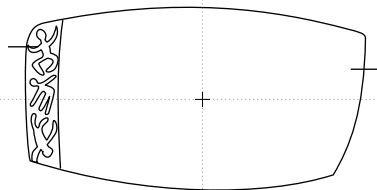

0 mm

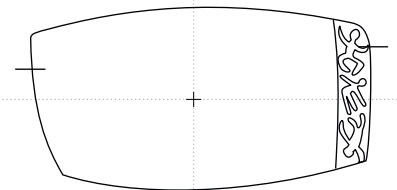

FERGIE

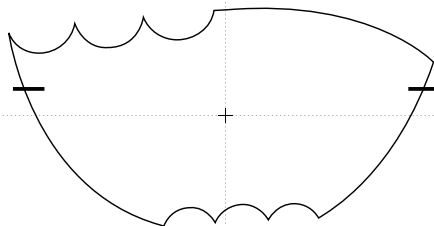

1,5 mm

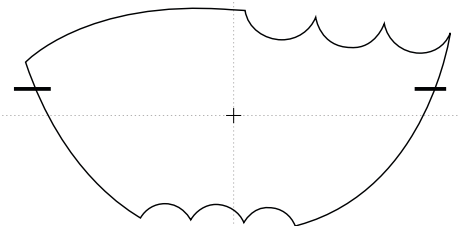



ateliér
kreativ

FERRON

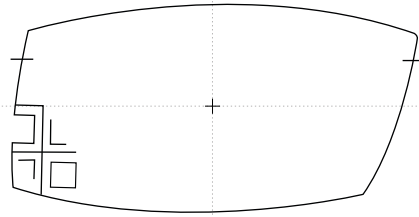

0,5 mm

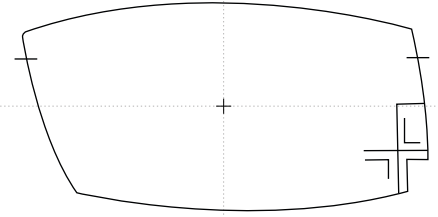

FIALKA

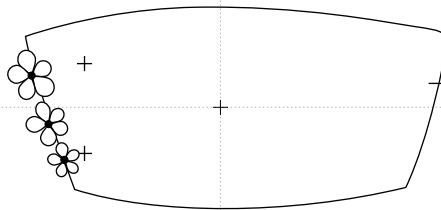

0,5 mm

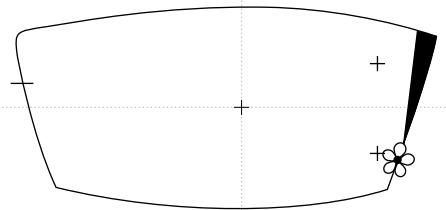

FILIP

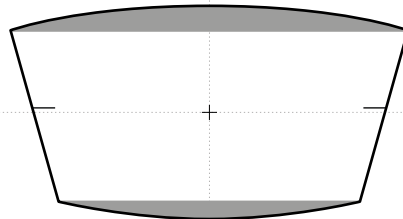

3 mm

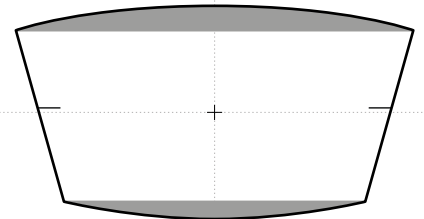

FIONA

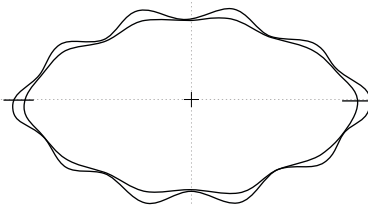

0 mm

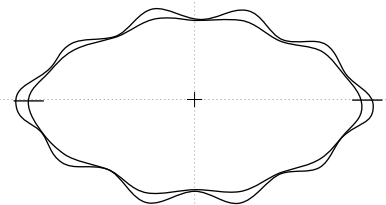

Tyto kreativní tvary brýlových čoček byly navrženy a vyrobeny v ateliéru kreativ při společnosti EYE 2000 s.r.o. a jsou chráněny Úřadem průmyslového vlastnictví jako průmyslový vzor. These creative glasses lens shapes were designed and produced by ateliér kreativ by EYE 2000 s.r.o. company and are patented and protected by the Authority of the Industrial Property.

EYE 2000 s.r.o. / Ohmova 271 / 109 00 Praha 10 / Czech Republic / Provozovna / Polubenská 614 / 468 61 Desná / Czech Republic
T +420 271 961 170 / www.eye2000.cz / info@eye2000.cz



ateliér
kreativ

FLAVIE

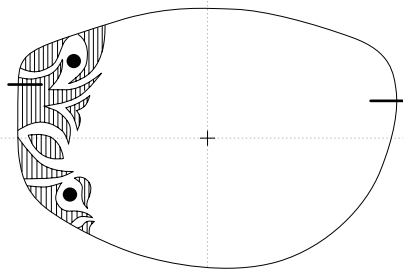

0 mm

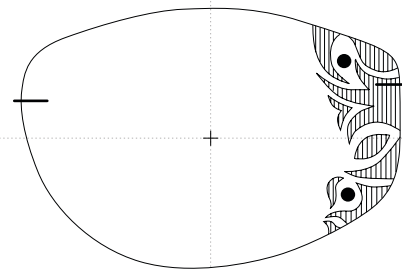

FLUORA

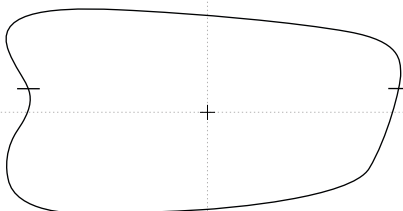

0,5 mm

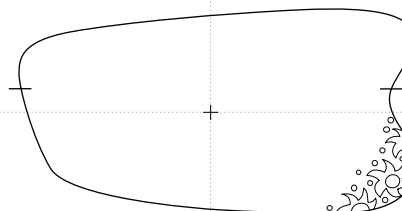

GABRIELA

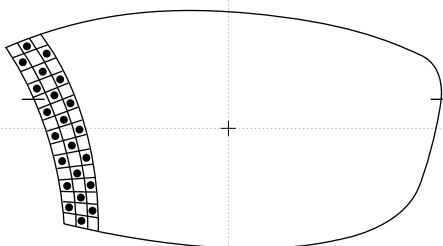

0 mm

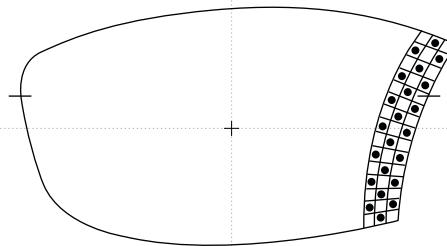

GALLA

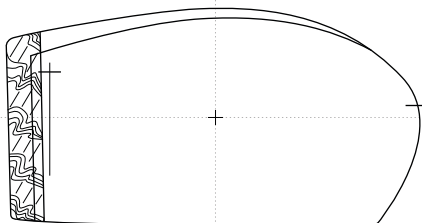

0 mm

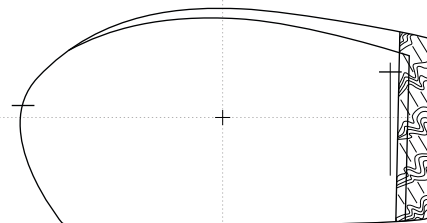

Tyto kreativní tvary brýlových čoček byly navrženy a vyrobeny v ateliéru kreativ při společnosti EYE 2000 s.r.o. a jsou chráněny Úřadem průmyslového vlastnictví jako průmyslový vzor.
These creative glasses lens shapes were designed and produced by ateliér kreativ by EYE 2000 s.r.o. company and are patented and protected by the Authority of the Industrial Property.

EYE 2000 s.r.o. / Ohmova 271 / 109 00 Praha 10 / Czech Republic / Provozovna / Polubenská 614 / 468 61 Desná / Czech Republic
T +420 271 961 170 / www.eye2000.cz / info@eye2000.cz

GERALDINA

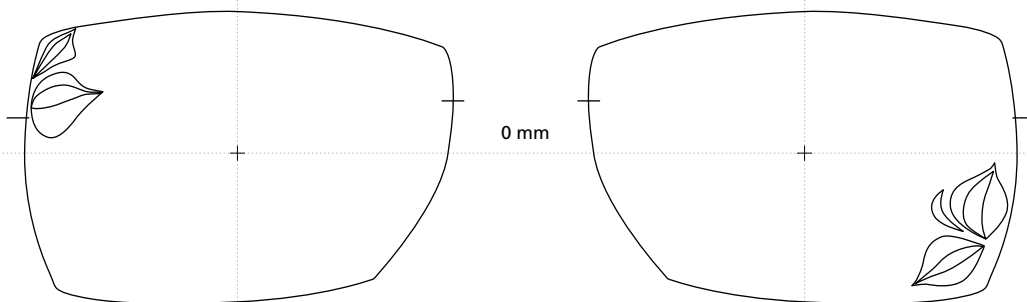

GILBERT

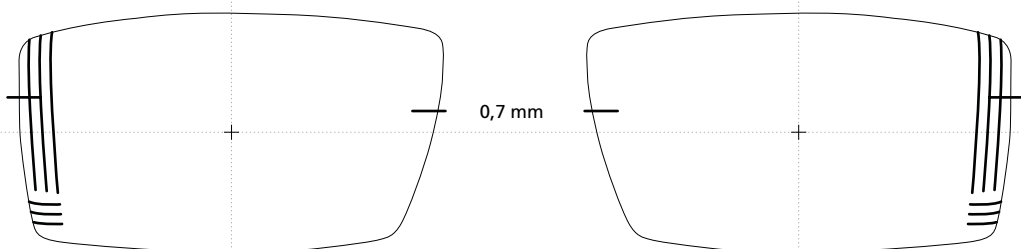

GITA

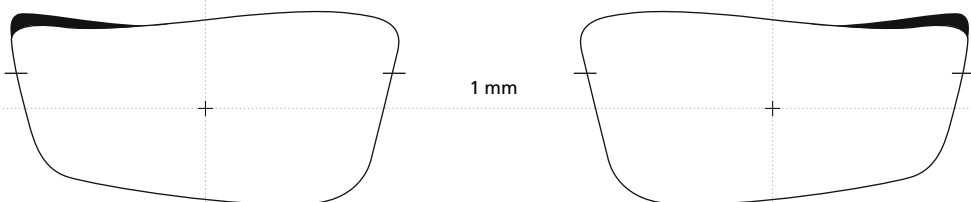

GIZELA

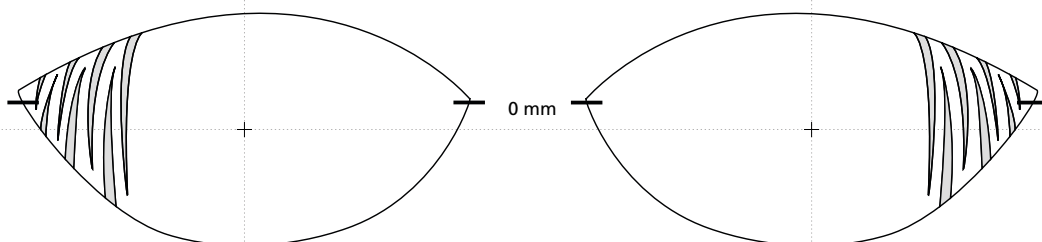

GRACIE

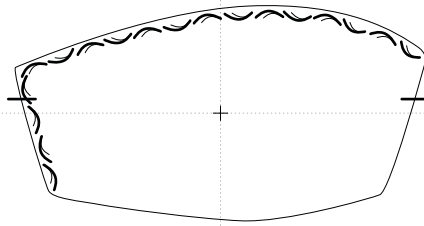

1,4 mm

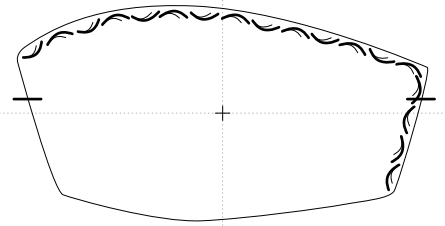

GREGOR

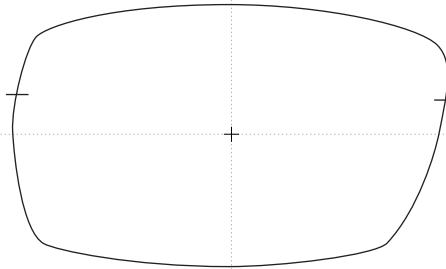

0,5 mm

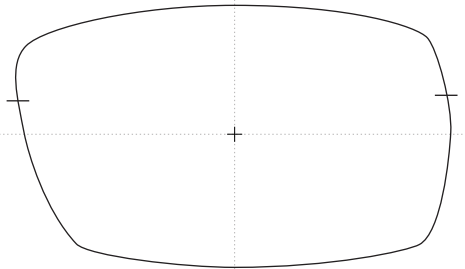

HANA

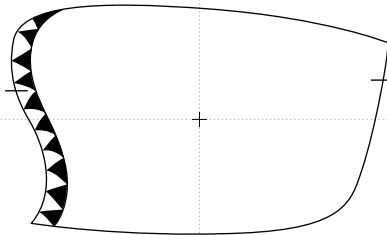

0,6 mm

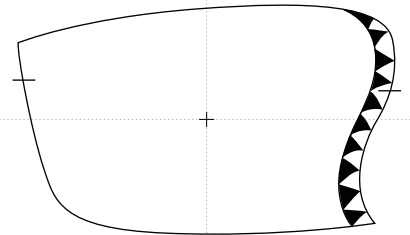

HANALORE

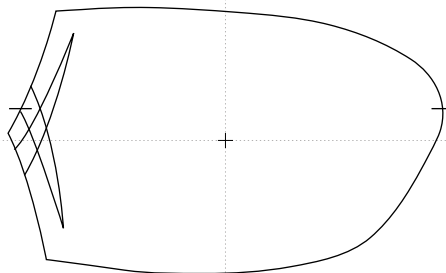

0 mm

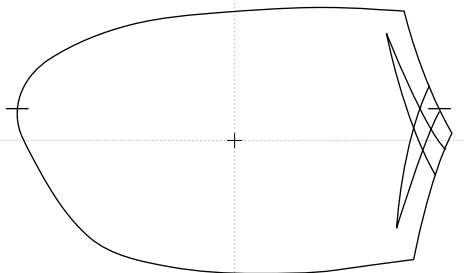

HASSI

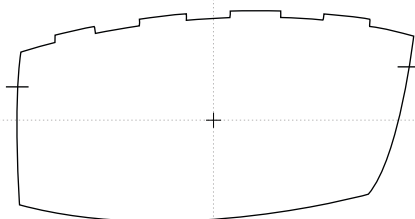

0,5 mm

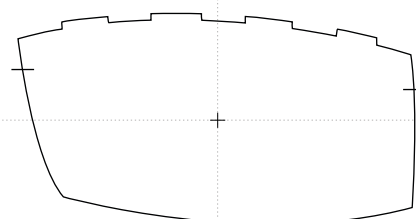

HEDVIKA

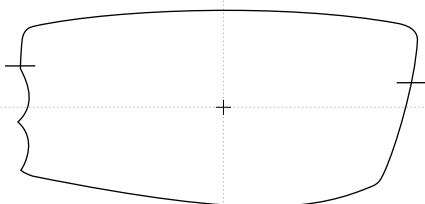

1 mm

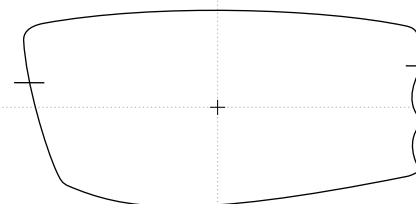

HELENKA

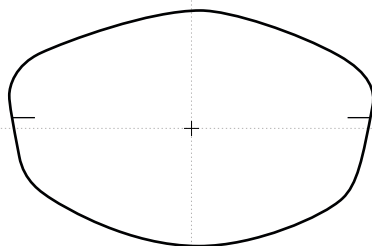

0,5 mm

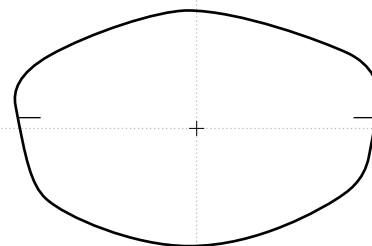

HELIA

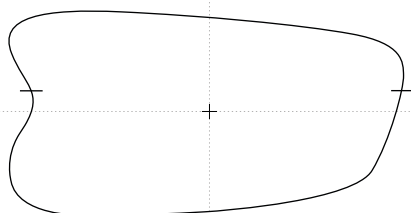

0,5 mm

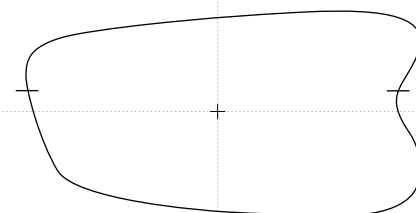

HERBERT

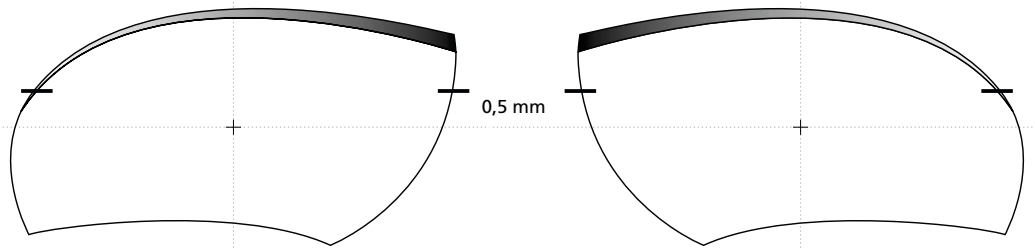

HERMINA

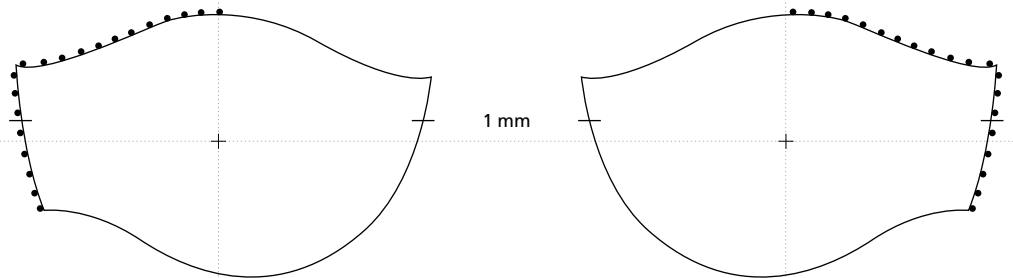

HORTENSIE

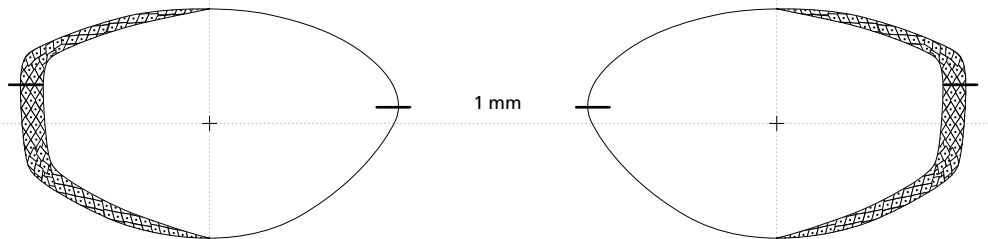

HUBERT

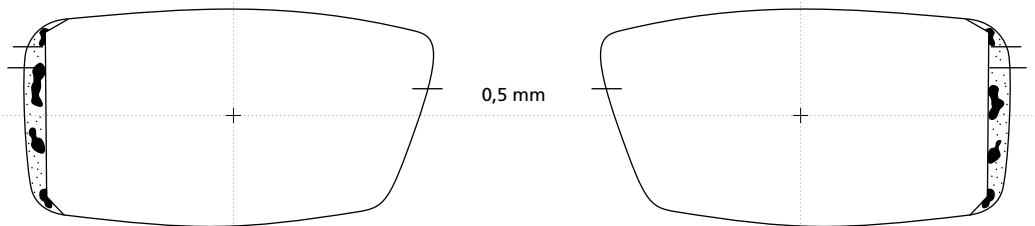



ateliér
kreativ

HYDRIA

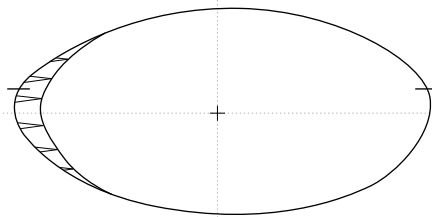

0,5 mm

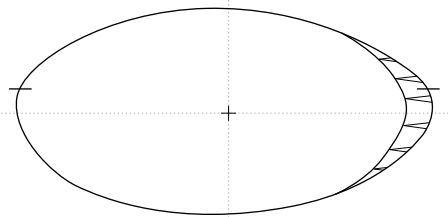

HYNEK

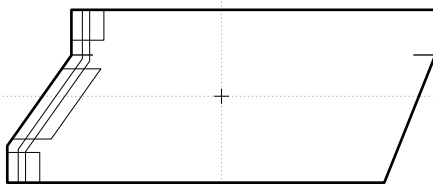

0 mm

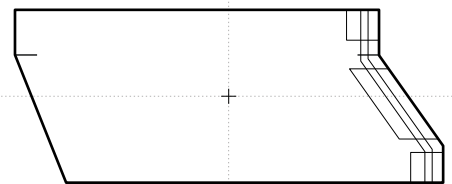

CHARLIE

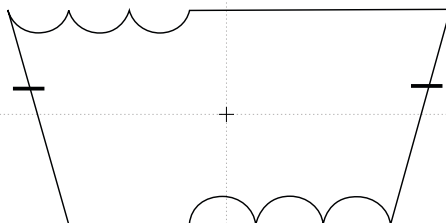

3,1 mm

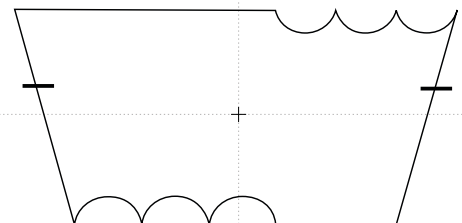

IDA

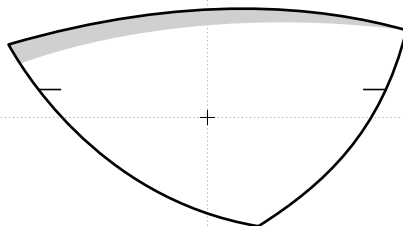

3 mm

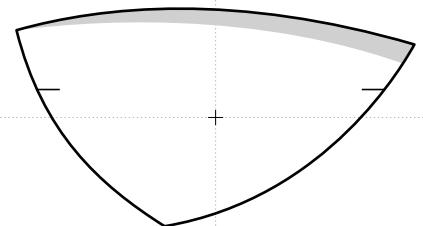

Tyto kreativní tvary brýlových čoček byly navrženy a vyrobeny v ateliéru kreativ při společnosti EYE 2000 s.r.o. a jsou chráněny Úřadem průmyslového vlastnictví jako průmyslový vzor.
These creative glasses lens shapes were designed and produced by ateliér kreativ by EYE 2000 s.r.o. company and are patented and protected by the Authority of the Industrial Property.

EYE 2000 s.r.o. / Ohmova 271 / 109 00 Praha 10 / Czech Republic / Provozovna / Polubenská 614 / 468 61 Desná / Czech Republic
T +420 271 961 170 / www.eye2000.cz / info@eye2000.cz



ateliér
kreativ

INGRID

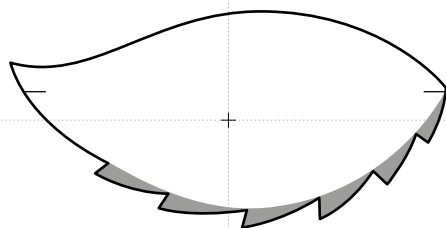

0 mm

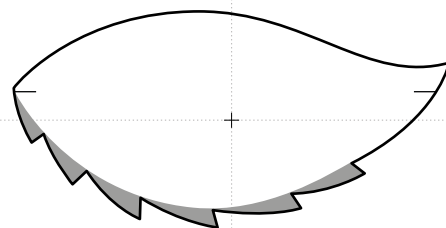

IRENA

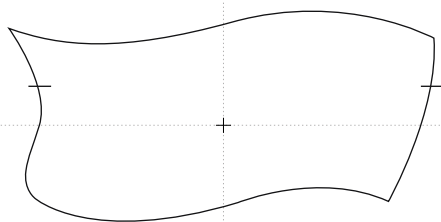

0,5 mm

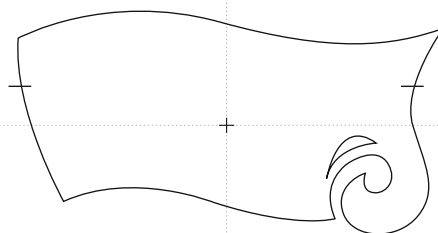

IRIDIA

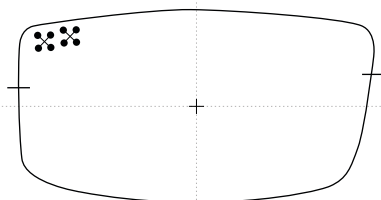

0,5 mm

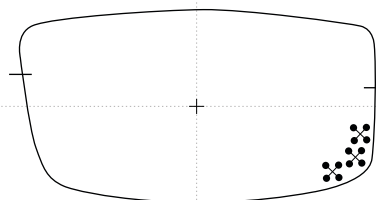

IRMA

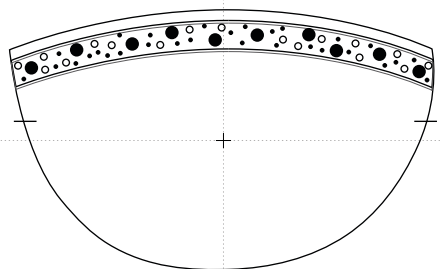

1 mm

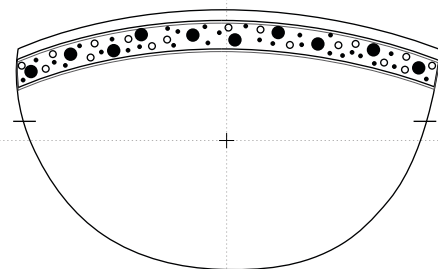

Tyto kreativní tvary brýlových čoček byly navrženy a vyrobeny v ateliéru kreativ při společnosti EYE 2000 s.r.o. a jsou chráněny Úřadem průmyslového vlastnictví jako průmyslový vzor. These creative glasses lens shapes were designed and produced by ateliér kreativ by EYE 2000 s.r.o. company and are patented and protected by the Authority of the Industrial Property.

EYE 2000 s.r.o. / Ohmova 271 / 109 00 Praha 10 / Czech Republic / Provozovna / Polubenská 614 / 468 61 Desná / Czech Republic
T +420 271 961 170 / www.eye2000.cz / info@eye2000.cz

ISABELA

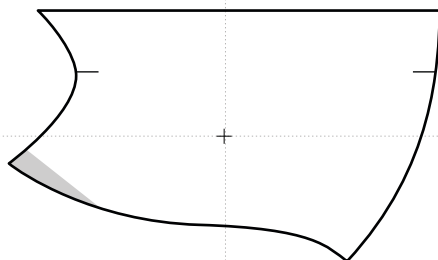

0,5 mm

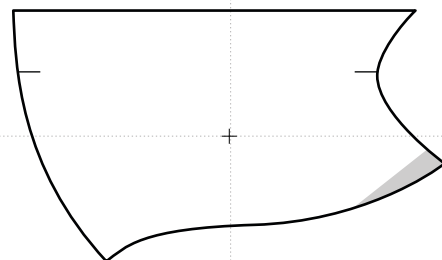

ISIS

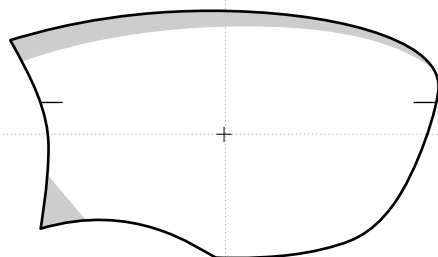

0,5 mm

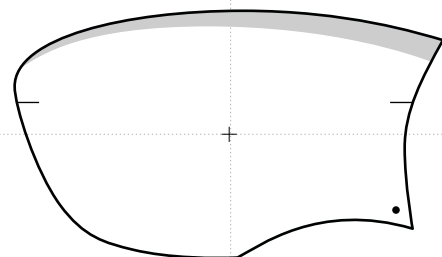

IVANKA

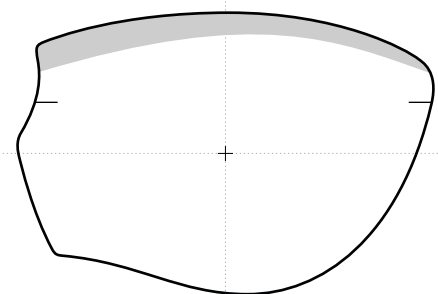

0,5 mm

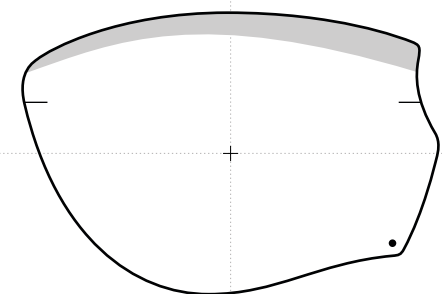

IVETA

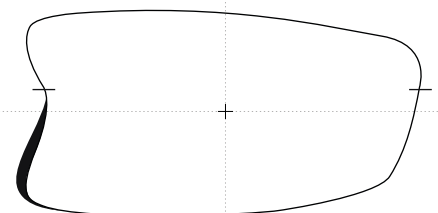

0 mm

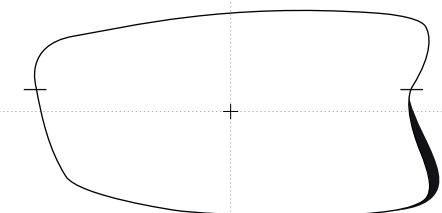

IVONA

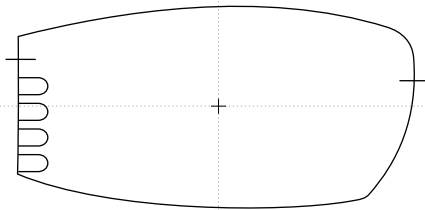

0 mm

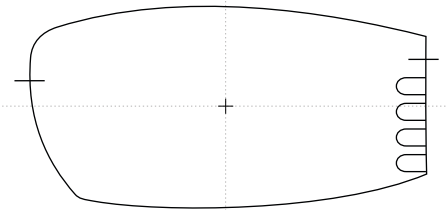

IZIDORA

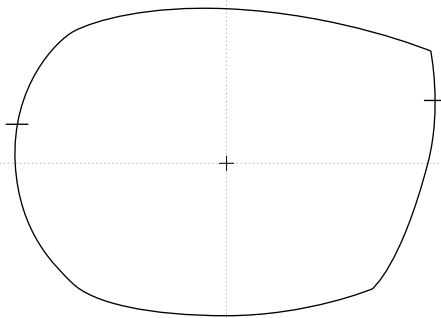

0 mm

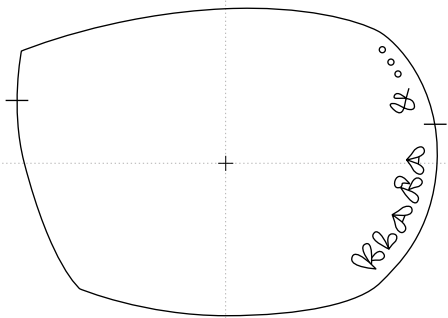

JACKIE

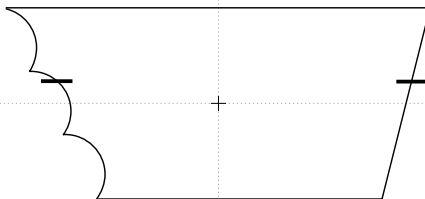

2,4 mm

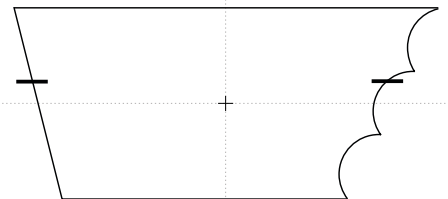

JAN

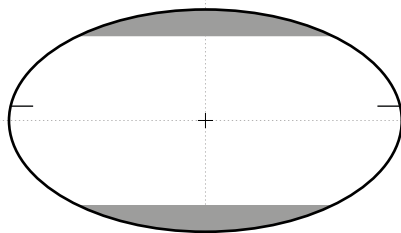

0,5 mm

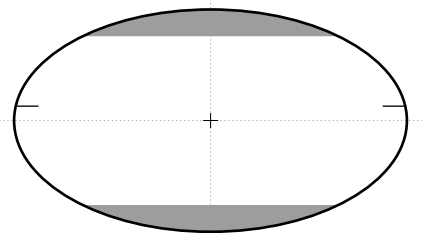

JARKA

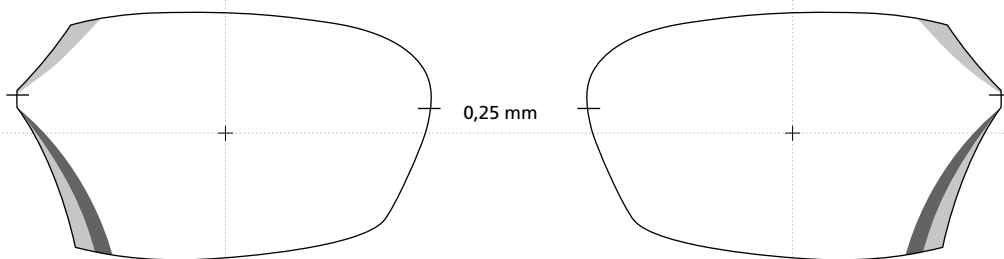

0,25 mm

JASNENKA

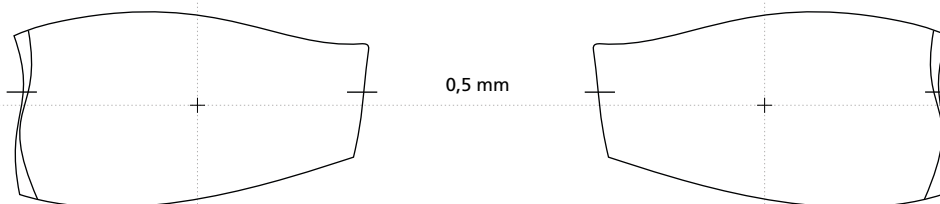

0,5 mm

JING-JANG

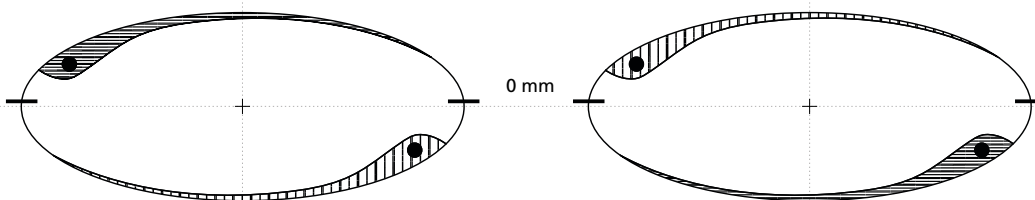

0 mm

JIRINA

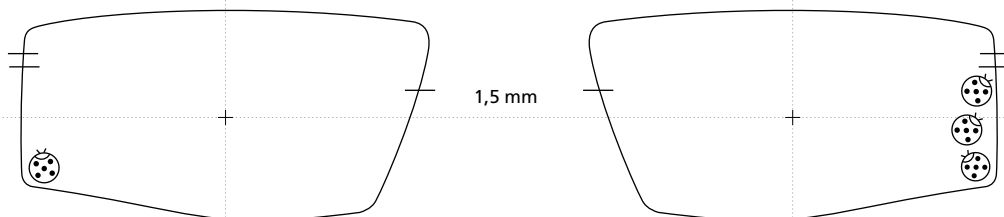

1,5 mm

JITKA

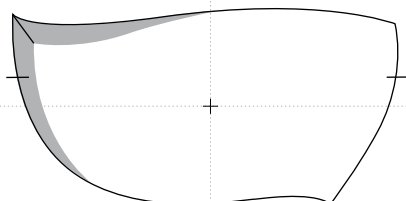

0,5 mm

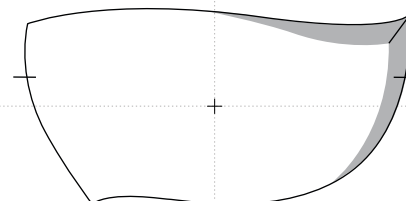

JITRENKA

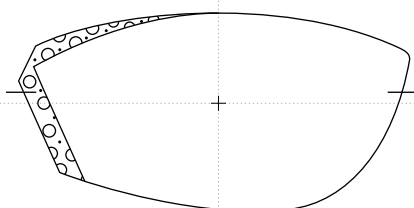

1 mm

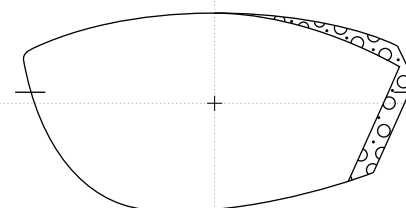

JOHANKA

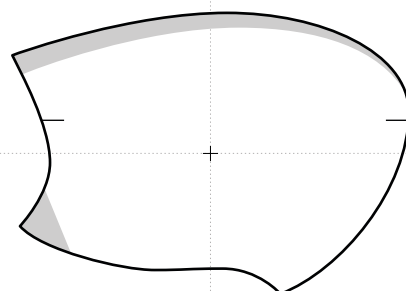

0 mm

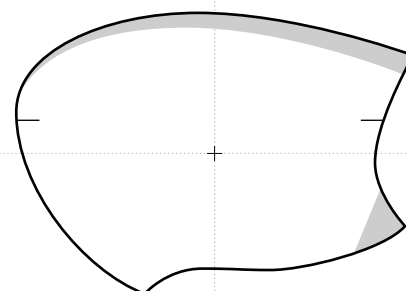

JOLANKA

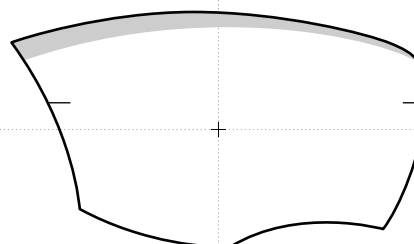

0 mm

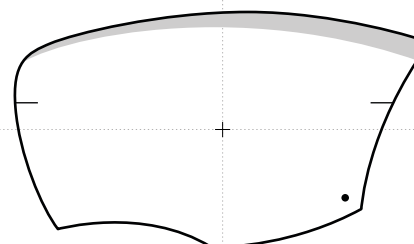

JORDANA

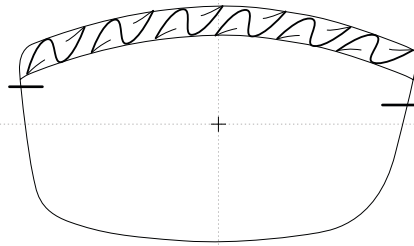

1,3 mm

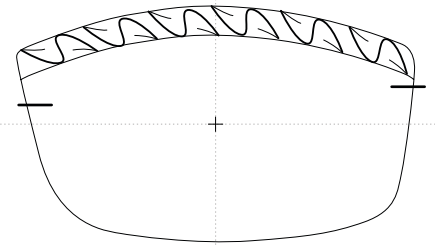

JUDITA

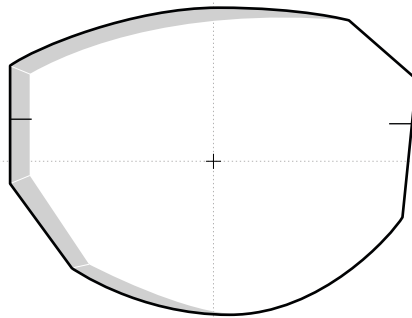

0,5 mm

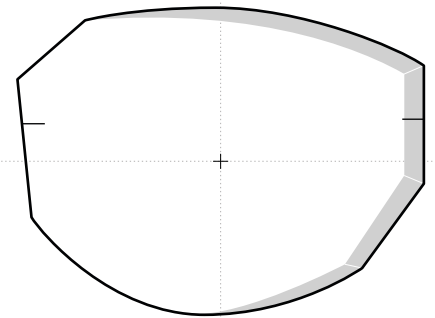

JULIE

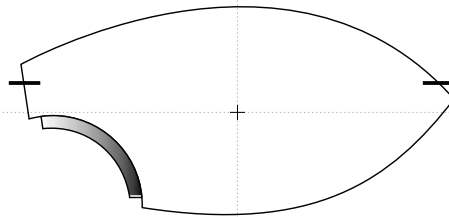

2 mm

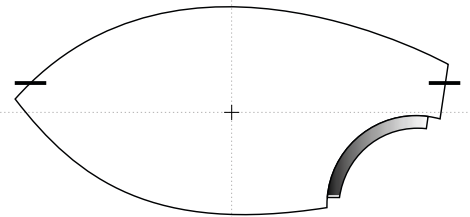

JULIUS

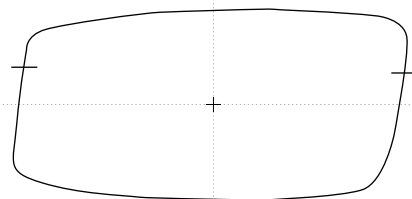

0,5 mm

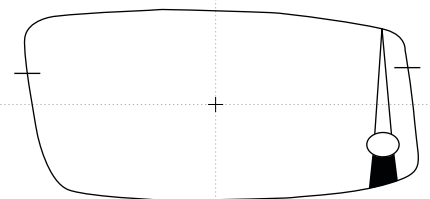



KALI

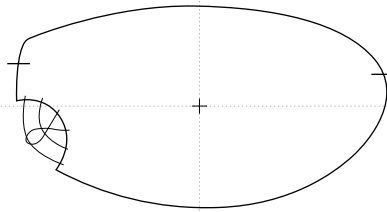

0,5 mm

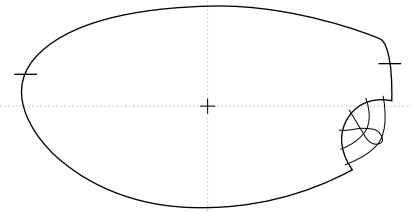

KAMIL

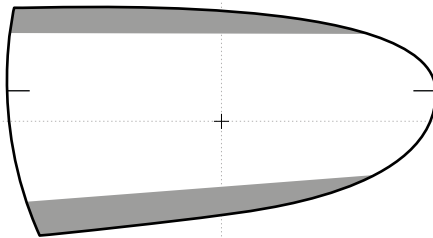

0 mm

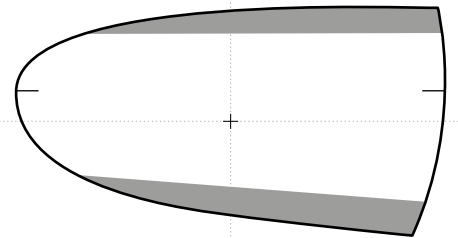

KAMILA

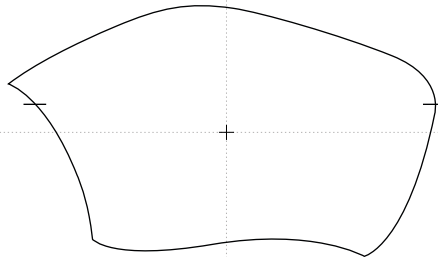

0 mm

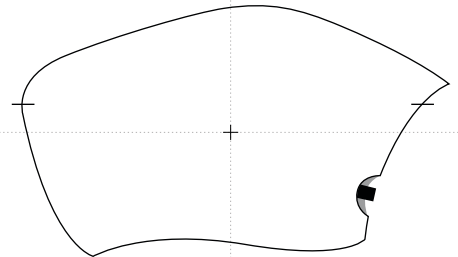

KAPRADI

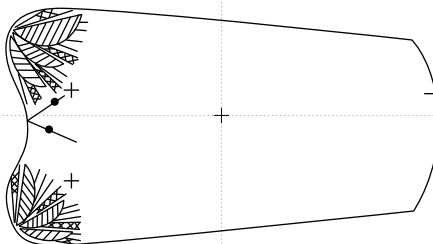

0,5 mm

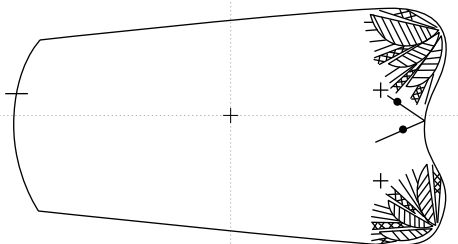

Tyto kreativní tvary brýlových čoček byly navrženy a vyrobeny v ateliéru kreativ při společnosti EYE 2000 s.r.o. a jsou chráněny Úřadem průmyslového vlastnictví jako průmyslový vzor.
These creative glasses lens shapes were designed and produced by atelier kreativ by EYE 2000 s.r.o. company and are patented and protected by the Authority of the Industrial Property.

EYE 2000 s.r.o. / Ohmova 271 / 109 00 Praha 10 / Czech Republic / Provozovna / Polubenská 614 / 468 61 Desná / Czech Republic
T +420 271 961 170 / www.eyeye2000.cz / info@eyeye2000.cz

KARA

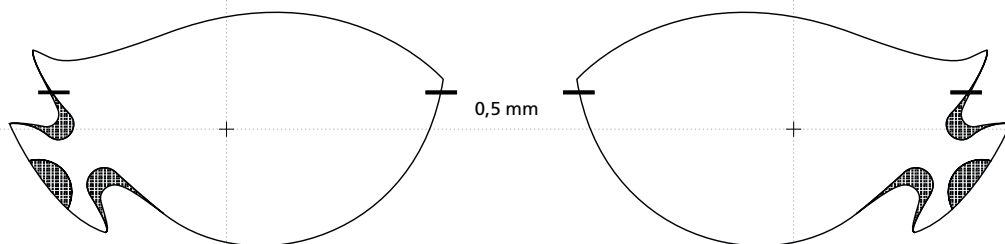

KARINA

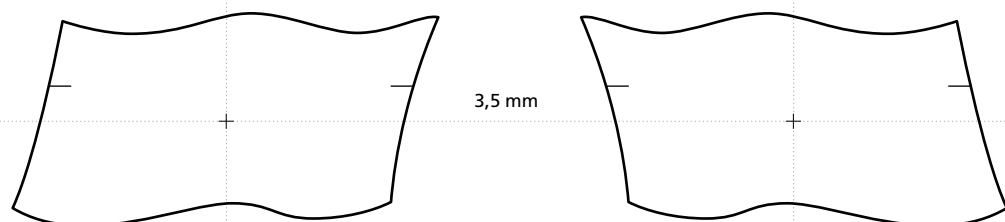

KARLA

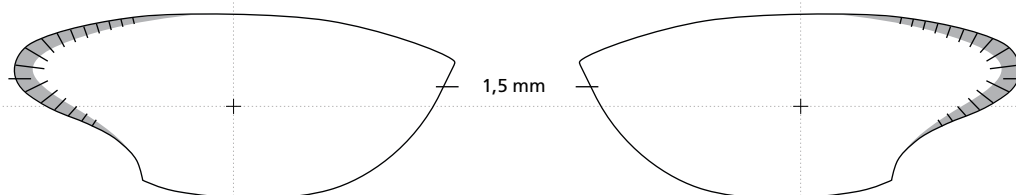

KAROLINA

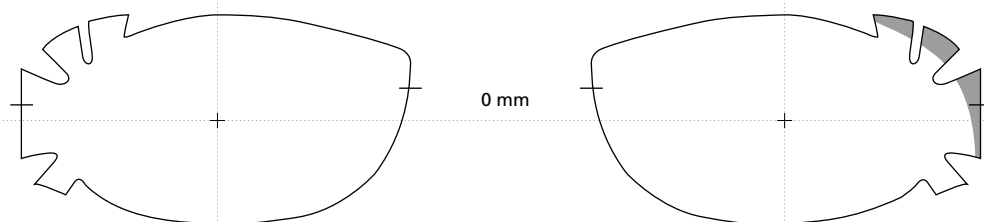

KAT

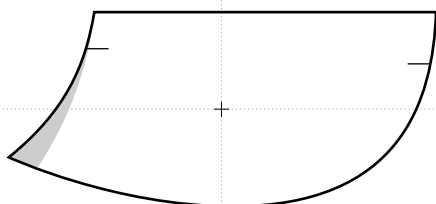

1 mm

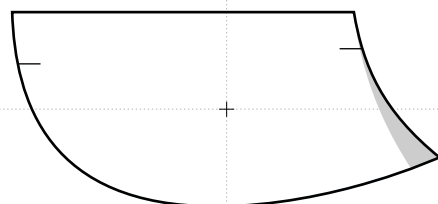

KATERINA

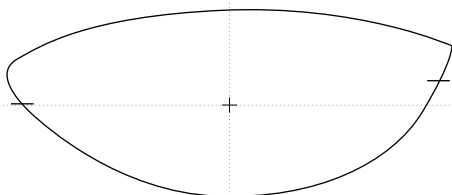

1,6 mm

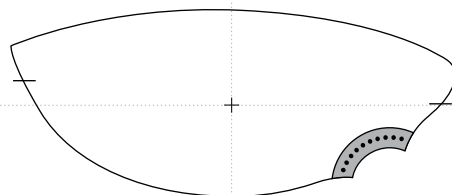

KLARA

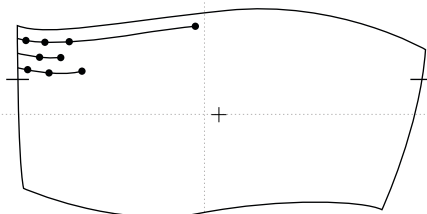

0,5 mm

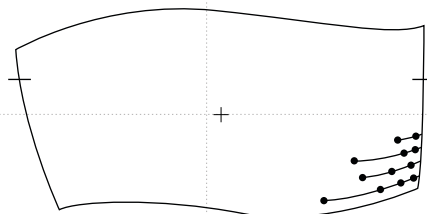

KLEMENTYNA

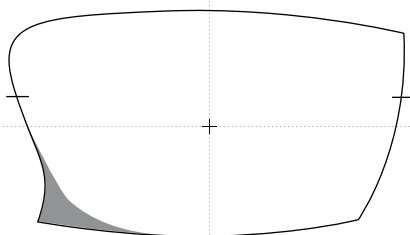

0,6 mm

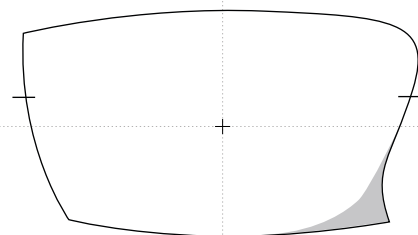

KOLECKA

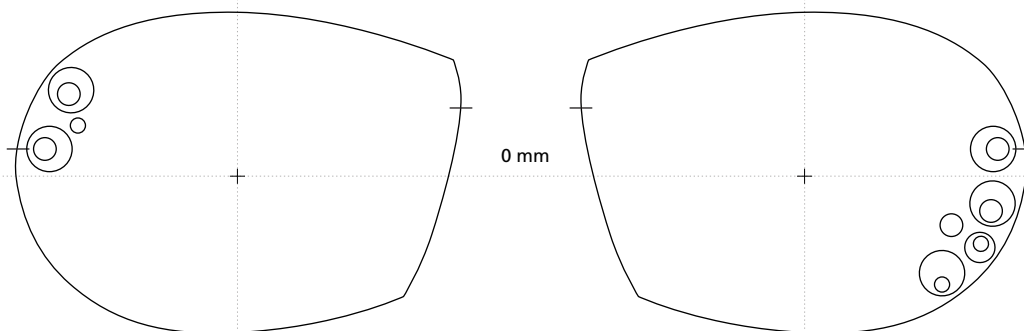

KOLETA

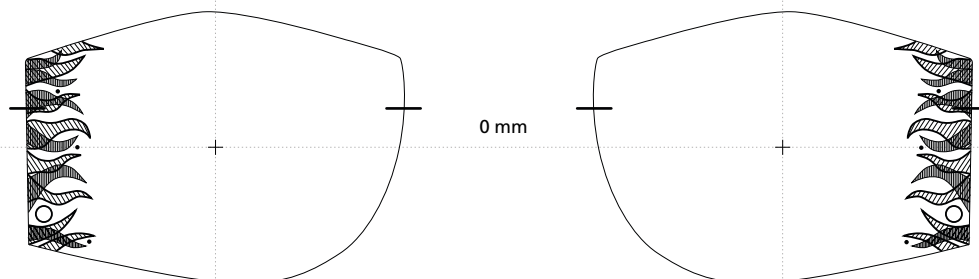

KOZOROH

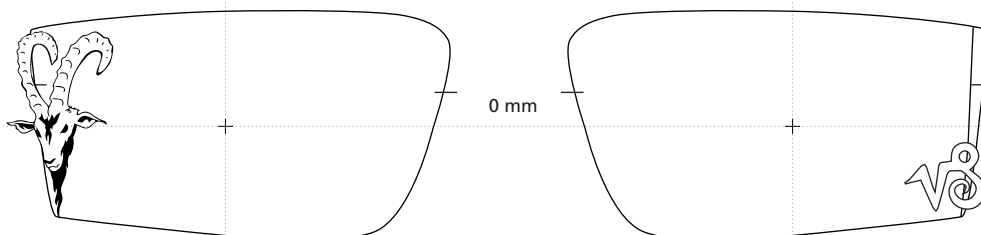

KRISTYNKA

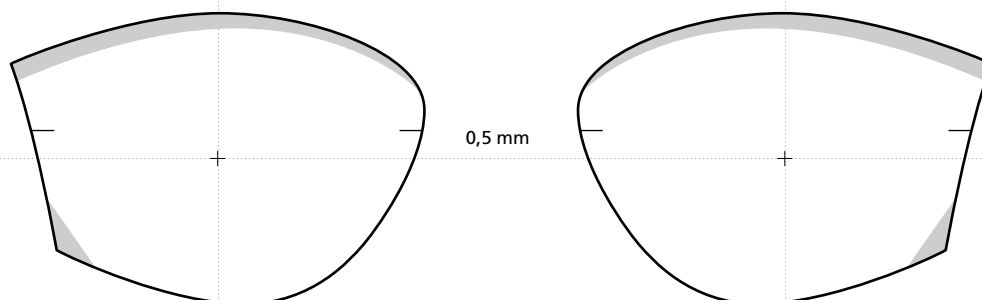

KRYSTOF

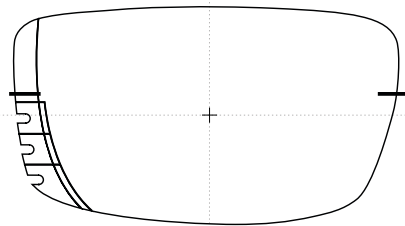

0,5 mm

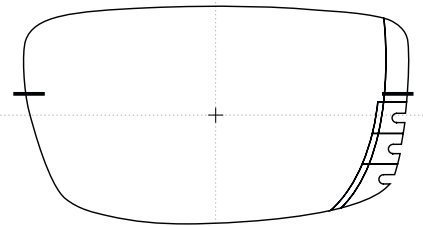

KRYTON

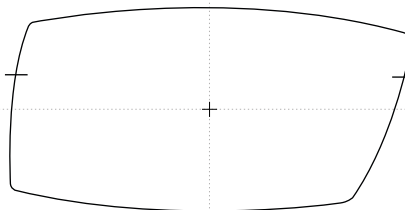

1 mm

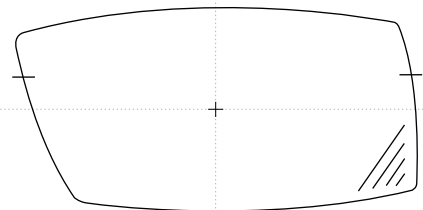

KVETA

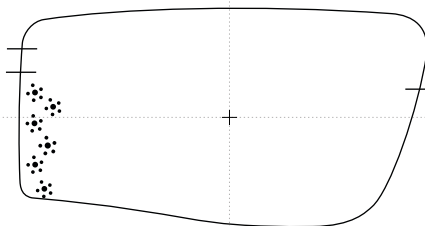

1 mm

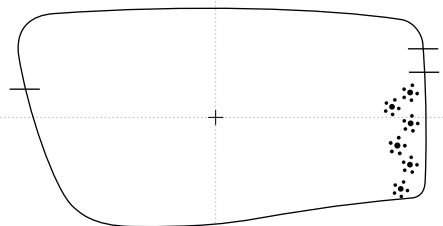

LADA

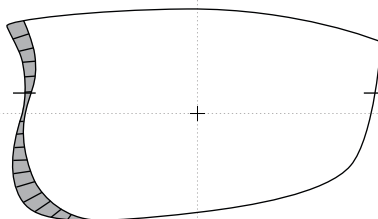

0,9 mm

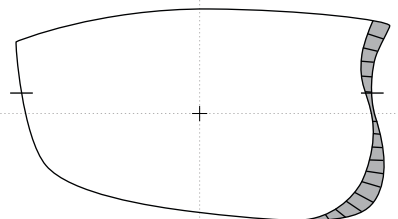



ateliér
kreativ

LAJLA

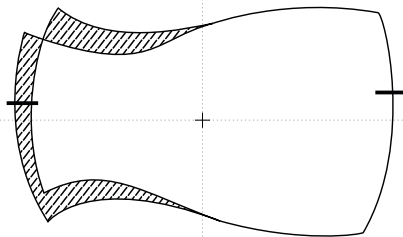

0 mm

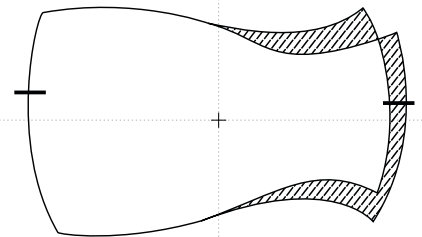

LAURA

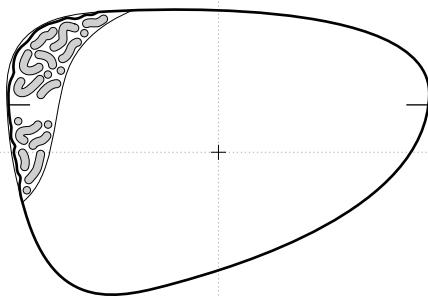

0 mm

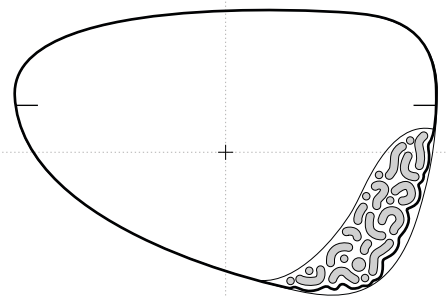

LEONA

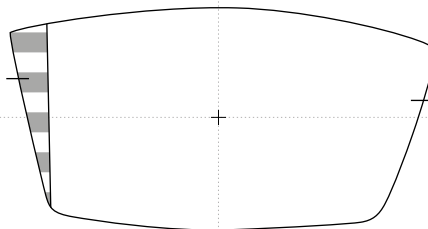

1 mm

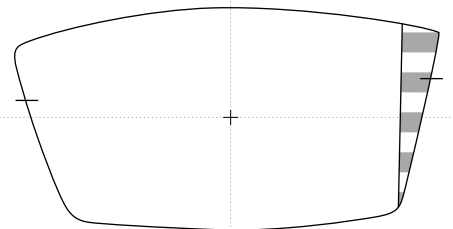

LEONARD

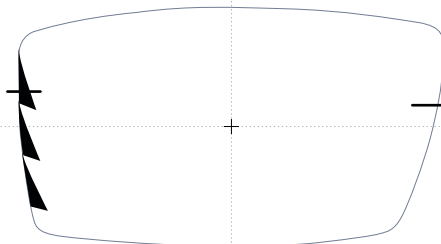

0,7 mm

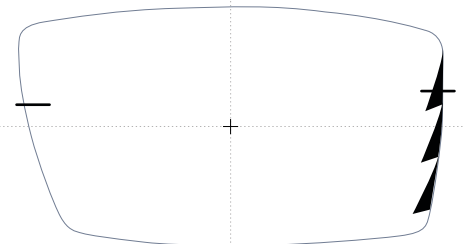

Tyto kreativní tvary brýlových čoček byly navrženy a vyrobeny v ateliéru kreativ při společnosti EYE 2000 s.r.o. a jsou chráněny Úřadem průmyslového vlastnictví jako průmyslový vzor.
These creative glasses lens shapes were designed and produced by ateliér kreativ by EYE 2000 s.r.o. company and are patented and protected by the Authority of the Industrial Property.

EYE 2000 s.r.o. / Ohmova 271 / 109 00 Praha 10 / Czech Republic / Provozovna / Polubenská 614 / 468 61 Desná / Czech Republic
T +420 271 961 170 / www.eye2000.cz / info@eye2000.cz



atelier
kreativ

LEONTYNA

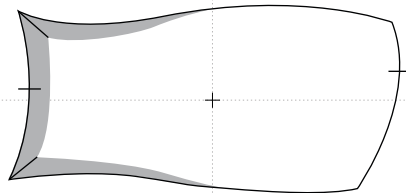

0 mm

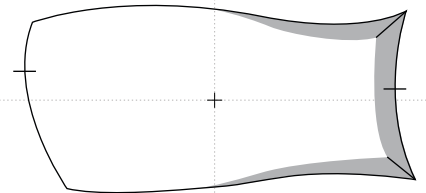

LETICIE

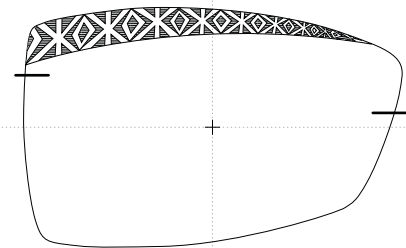

1 mm

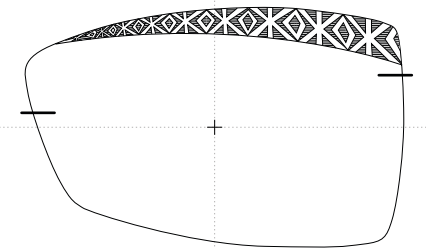

LEV

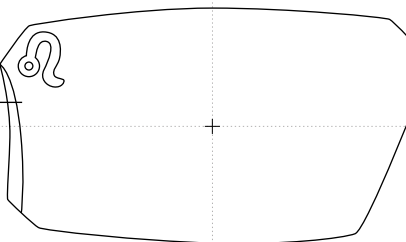

0,5 mm

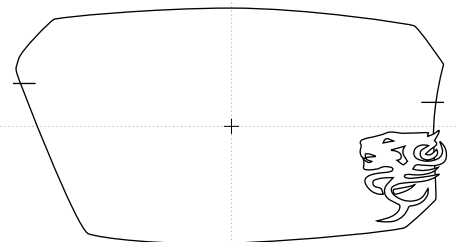

LILIANA

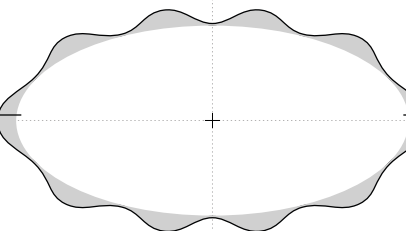

0 mm

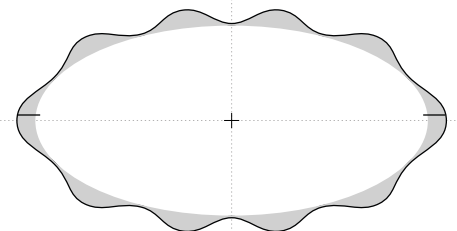

Tyto kreativní tvary brýlových čoček byly navrženy a vyrobeny v ateliéru kreativ při společnosti EYE 2000 s.r.o. a jsou chráněny Úřadem průmyslového vlastnictví jako průmyslový vzor. These creative glasses lens shapes were designed and produced by atelier kreativ by EYE 2000 s.r.o. company and are patented and protected by the Authority of the Industrial Property.

EYE 2000 s.r.o. / Ohmova 271 / 109 00 Praha 10 / Czech Republic / Provozovna / Polubenská 614 / 468 61 Desná / Czech Republic
T +420 271 961 170 / www.eye2000.cz / info@eye2000.cz



ateliér
kreativ

LILIE

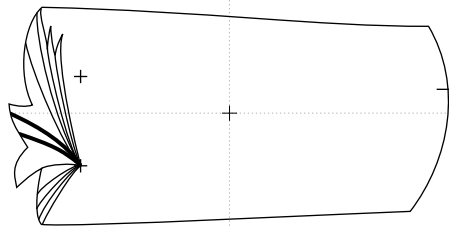

0 mm

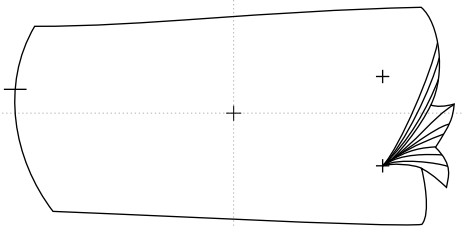

LINDA

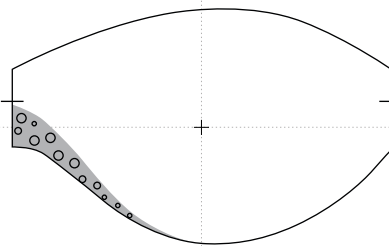

0 mm

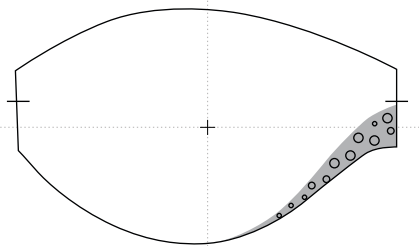

LJUBA

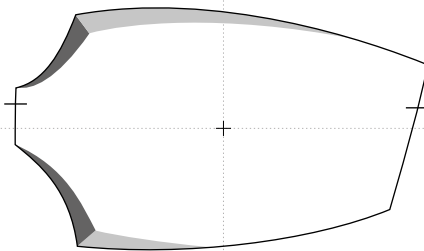

1,5 mm

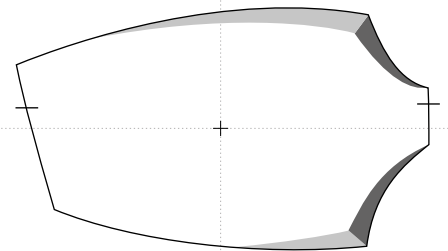

LOTA

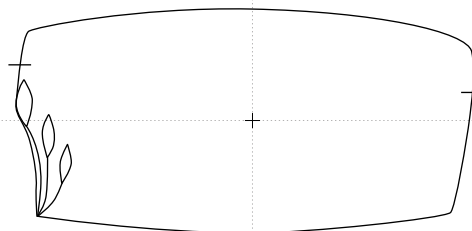

0 mm

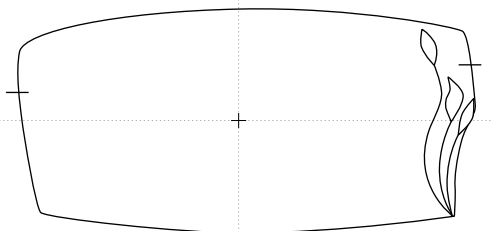

Tyto kreativní tvary brýlových čoček byly navrženy a vyrobeny v ateliéru kreativ při společnosti EYE 2000 s.r.o. a jsou chráněny Úřadem průmyslového vlastnictví jako průmyslový vzor.
These creative glasses lens shapes were designed and produced by ateliér kreativ by EYE 2000 s.r.o. company and are patented and protected by the Authority of the Industrial Property.

EYE 2000 s.r.o. / Ohmova 271 / 109 00 Praha 10 / Czech Republic / Provozovna / Polubenská 614 / 468 61 Desná / Czech Republic
T +420 271 961 170 / www.eye2000.cz / info@eye2000.cz

LUCIE

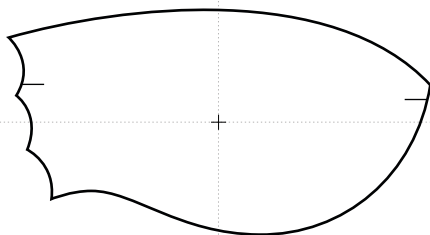

0,5 mm

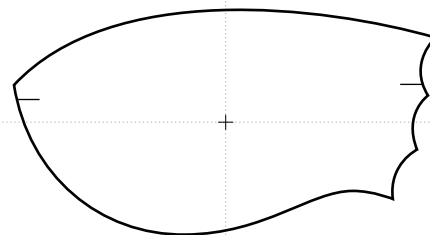

LUDOVITA

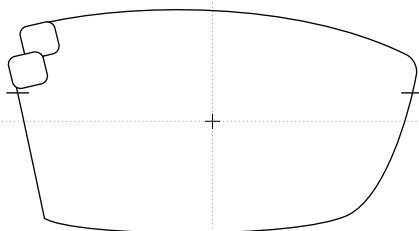

1 mm

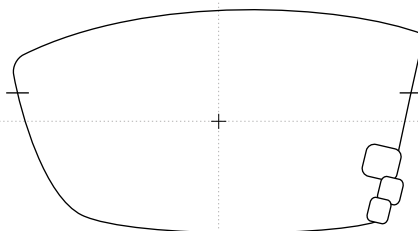

LUKAS

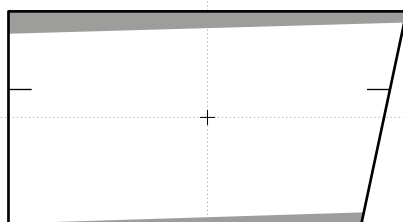

2 mm

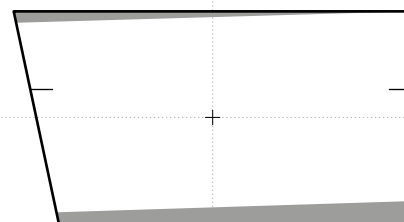

LUTETIA

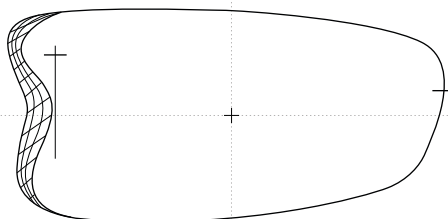

0 mm

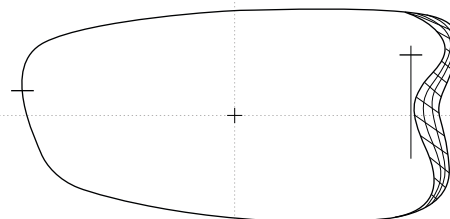

LYDIE

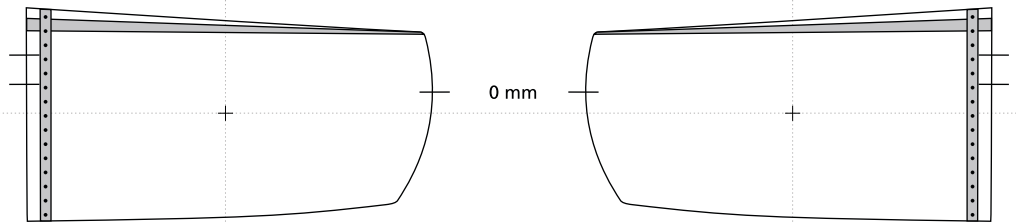

MAGDALENA

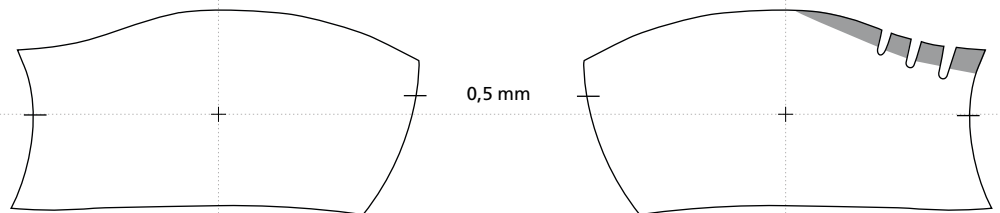

MAGNA

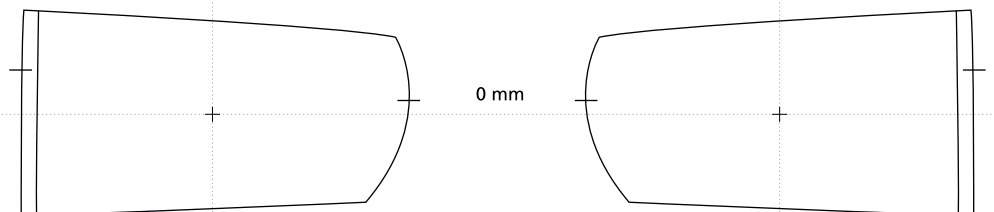

MAHULENA

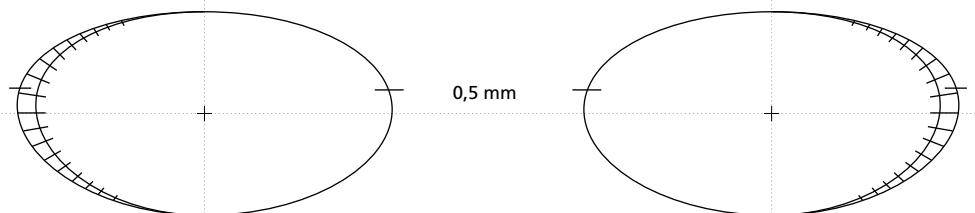



ateliér
kreativ

MARCELA

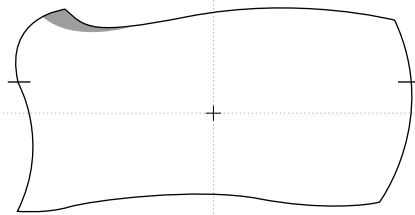

0 mm

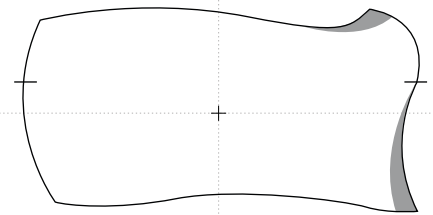

MAREK

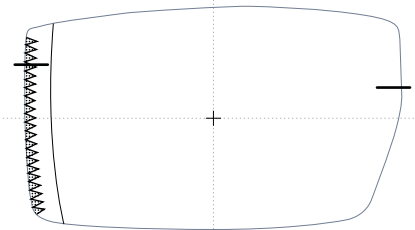

0 mm

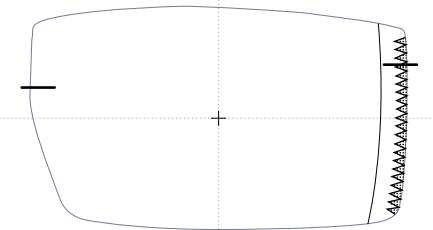

MARGIT

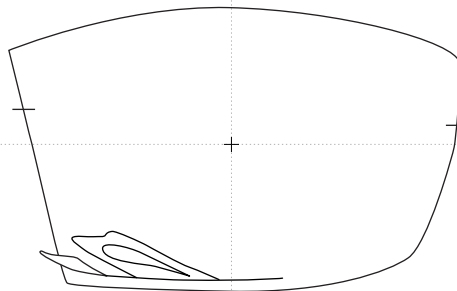

0,5 mm

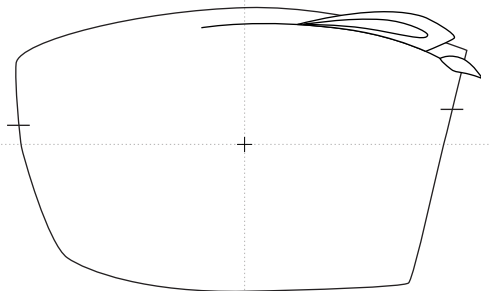

MARIAN

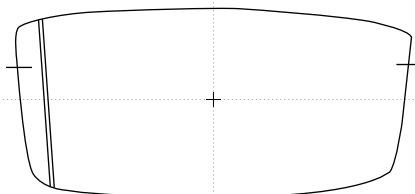

0,5 mm

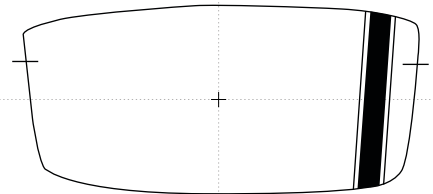

Tyto kreativní tvary brýlových čoček byly navrženy a vyrobeny v ateliéru kreativ při společnosti EYE 2000 s.r.o. a jsou chráněny Úřadem průmyslového vlastnictví jako průmyslový vzor.
These creative glasses lens shapes were designed and produced by ateliér kreativ by EYE 2000 s.r.o. company and are patented and protected by the Authority of the Industrial Property.

EYE 2000 s.r.o. / Ohmova 271 / 109 00 Praha 10 / Czech Republic / Provozovna / Polubenská 614 / 468 61 Desná / Czech Republic
T +420 271 961 170 / www.eye2000.cz / info@eye2000.cz



ateliér
kreativ

MARIKA

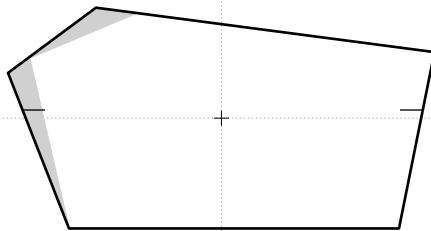

1,5 mm

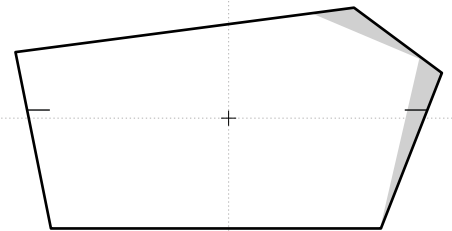

MARKETA

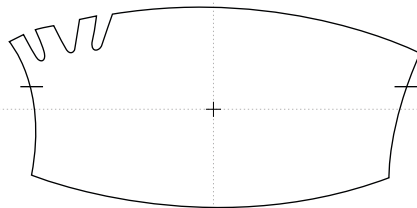

2 mm

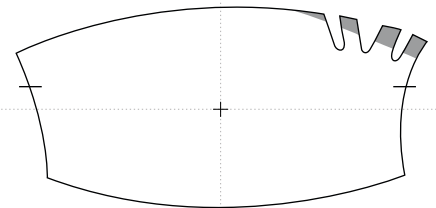

MARTA

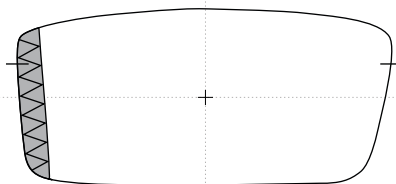

0,5 mm

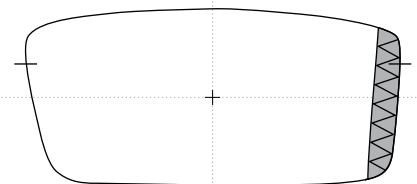

MARTIN

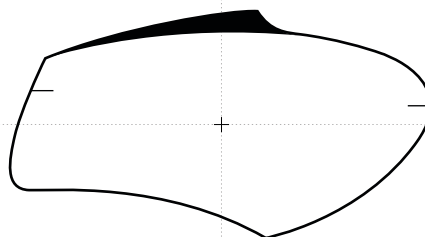

0 mm

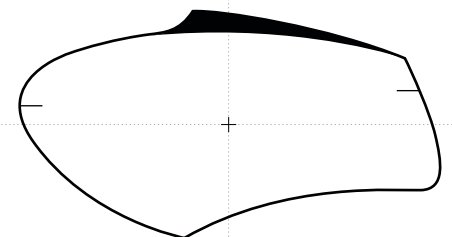

Tyto kreativní tvary brýlových čoček byly navrženy a vyrobeny v ateliéru kreativ při společnosti EYE 2000 s.r.o. a jsou chráněny Úřadem průmyslového vlastnictví jako průmyslový vzor. These creative glasses lens shapes were designed and produced by ateliér kreativ by EYE 2000 s.r.o. company and are patented and protected by the Authority of the Industrial Property.

EYE 2000 s.r.o. / Ohmova 271 / 109 00 Praha 10 / Czech Republic / Provozovna / Polubenská 614 / 468 61 Desná / Czech Republic
T +420 271 961 170 / www.eye2000.cz / info@eye2000.cz



atelier
kreativ

MARTINA

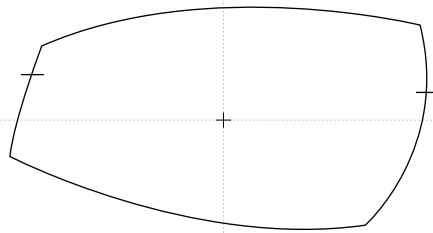

0 mm

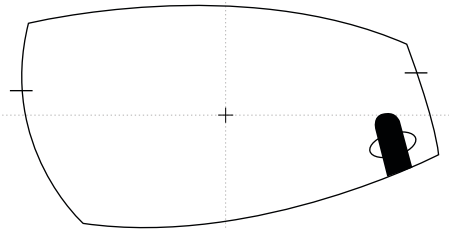

MARUSKA

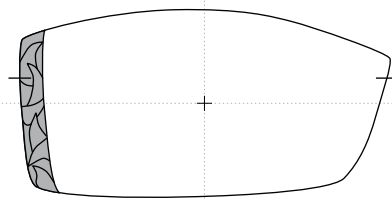

0,6 mm

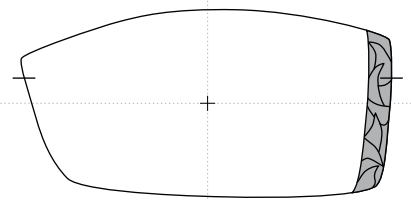

MASLE

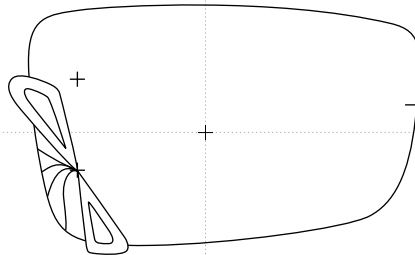

0 mm

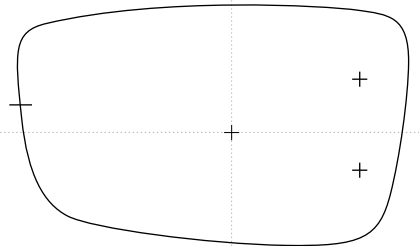

MATYAS

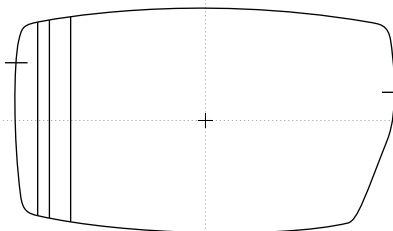

0 mm

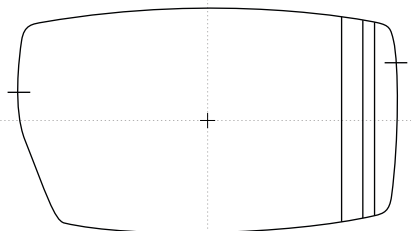

Tyto kreativní tvary brýlových čoček byly navrženy a vyrobeny v ateliéru kreativ při společnosti EYE 2000 s.r.o. a jsou chráněny Úřadem průmyslového vlastnictví jako průmyslový vzor.
These creative glasses lens shapes were designed and produced by atelier kreativ by EYE 2000 s.r.o. company and are patented and protected by the Authority of the Industrial Property.

EYE 2000 s.r.o. / Ohmova 271 / 109 00 Praha 10 / Czech Republic / Provozovna / Polubenská 614 / 468 61 Desná / Czech Republic
T +420 271 961 170 / www.eye2000.cz / info@eye2000.cz

MATYLDA

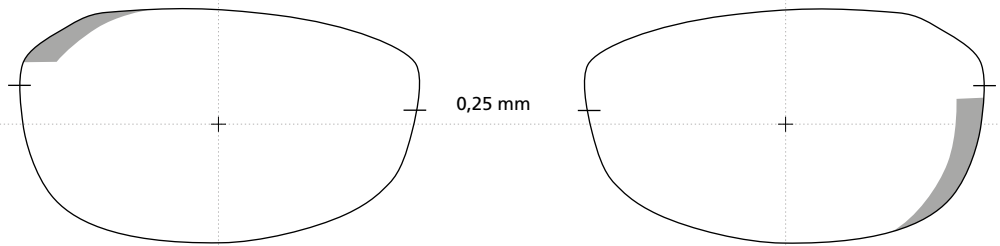

MAURICIUS

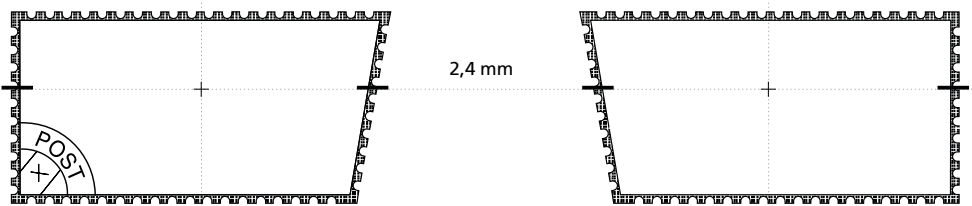

MAX

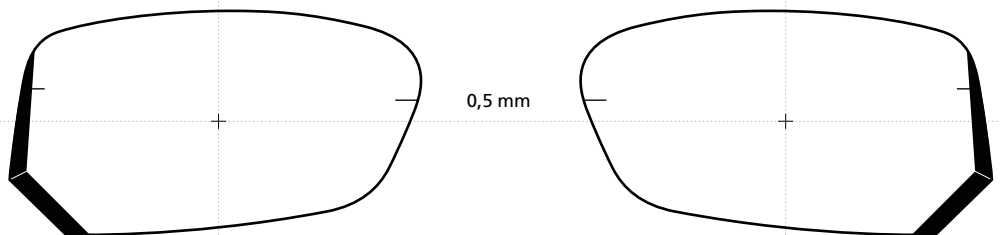

MEDARD

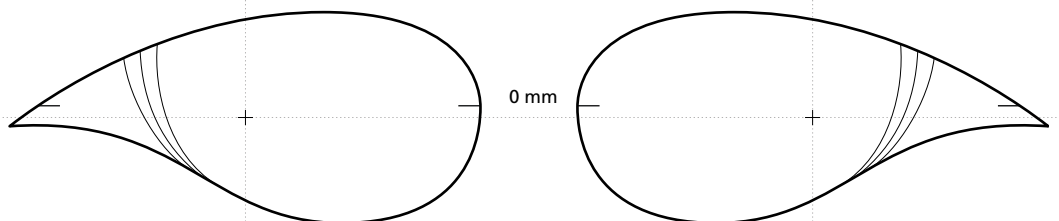

MICHAELA

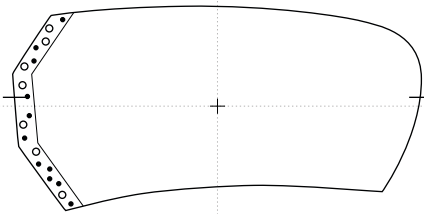

0 mm

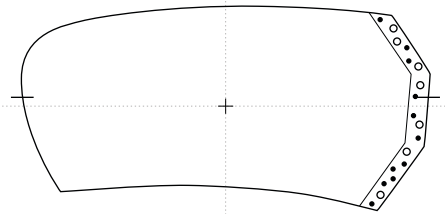

MILADA

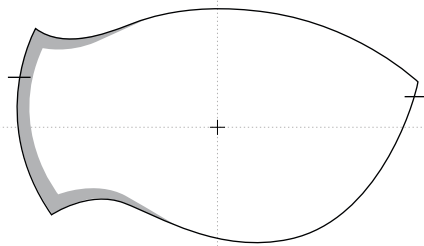

0,5 mm

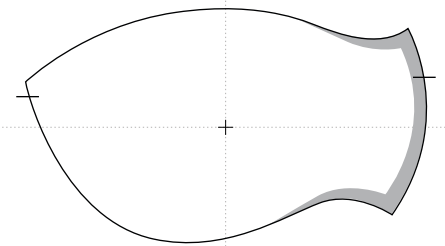

MILDRED

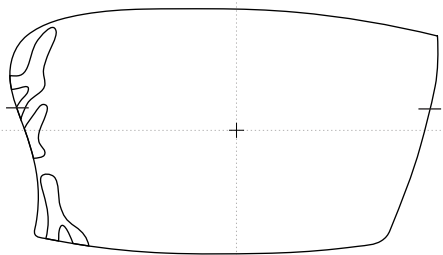

1 mm

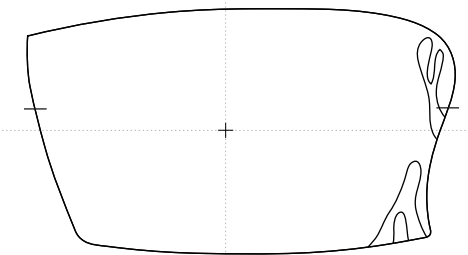

MILENA

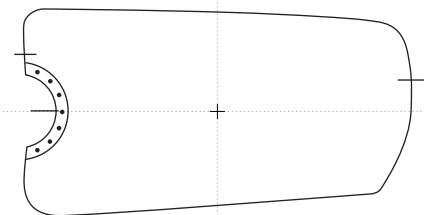

0 mm

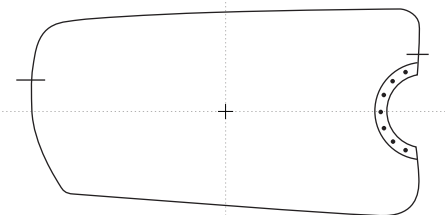

MILUSE

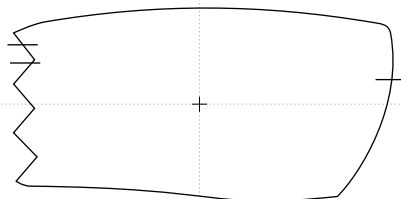

0 mm

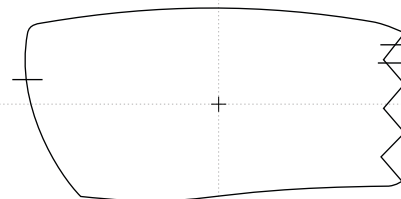

MIRIAM

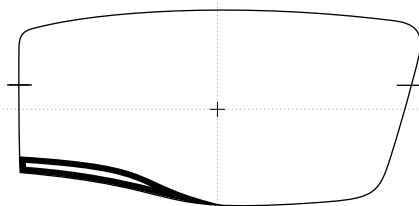

0,5 mm

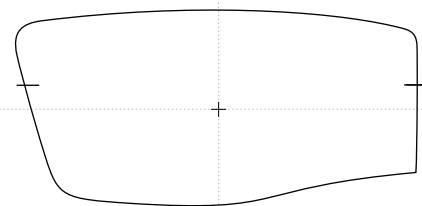

MIRKA

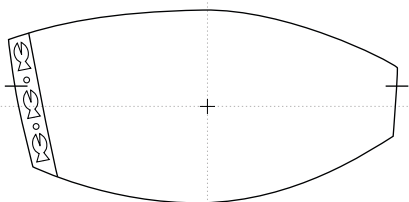

0 mm

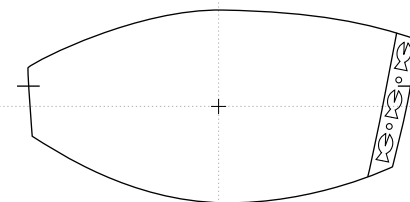

MONA

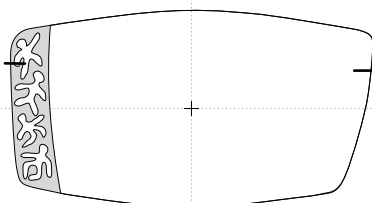

0,5 mm

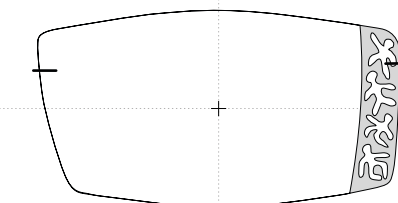



atelier
kreativ

MONIKA

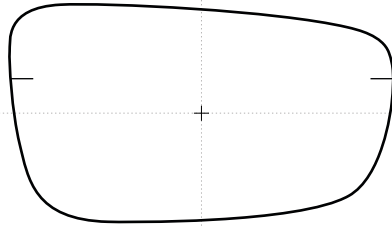

0 mm

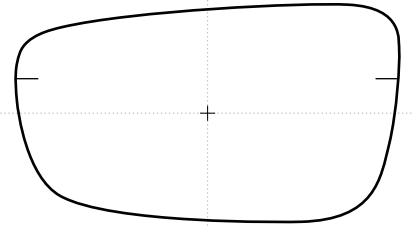

MOTYL

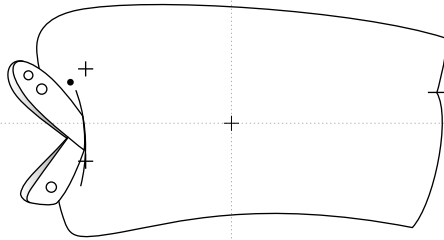

1 mm

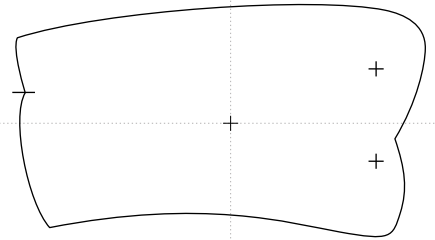

NATALKA

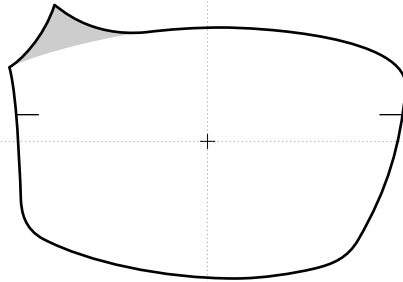

0,5 mm

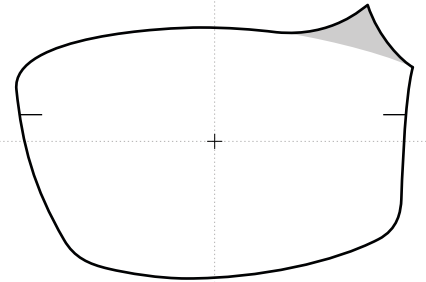

NATREA

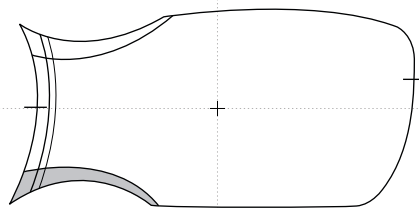

0 mm

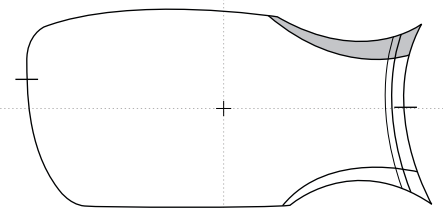

Tyto kreativní tvary brýlových čoček byly navrženy a vyrobeny v ateliéru kreativ při společnosti EYE 2000 s.r.o. a jsou chráněny Úřadem průmyslového vlastnictví jako průmyslový vzor.
These creative glasses lens shapes were designed and produced by atelier kreativ by EYE 2000 s.r.o. company and are patented and protected by the Authority of the Industrial Property.

EYE 2000 s.r.o. / Ohmova 271 / 109 00 Praha 10 / Czech Republic / Provozovna / Polubenská 614 / 468 61 Desná / Czech Republic
T +420 271 961 170 / www.eye2000.cz / info@eye2000.cz

NEFERTITI

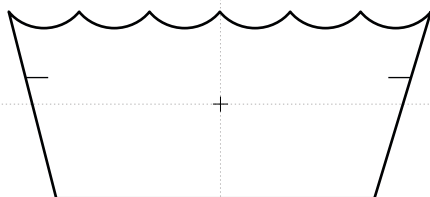

3 mm

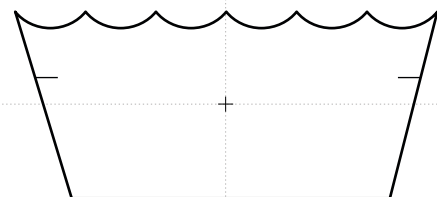

NEFRU

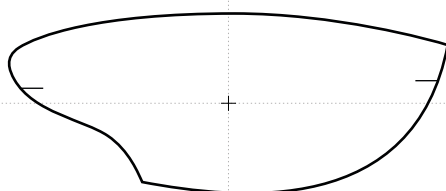

1,5 mm

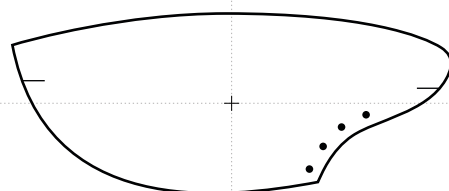

NELA

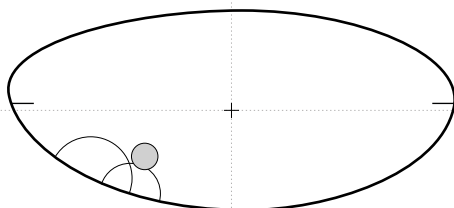

0 mm

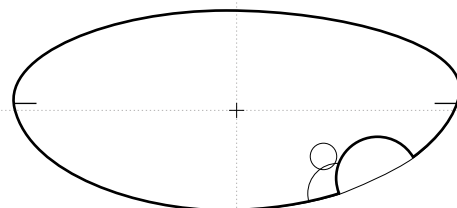

NEONA

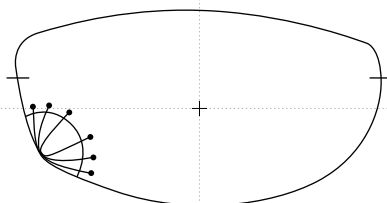

0 mm

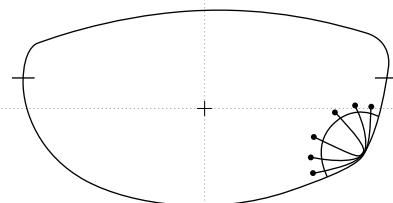

NERO

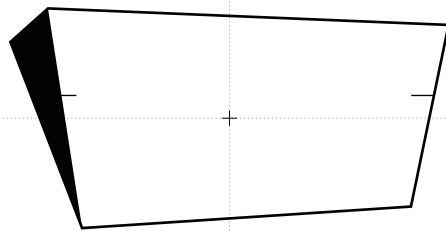

2 mm

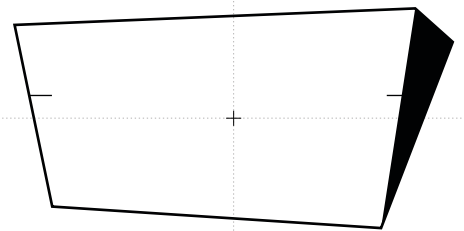

NICKY

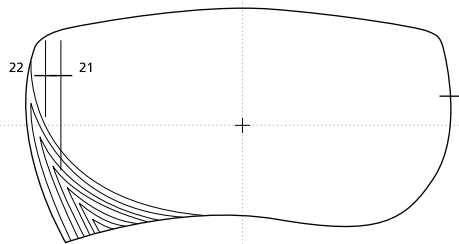

0 mm

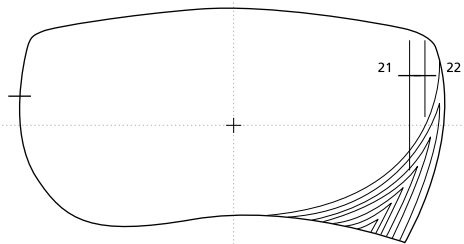

NIKOLA

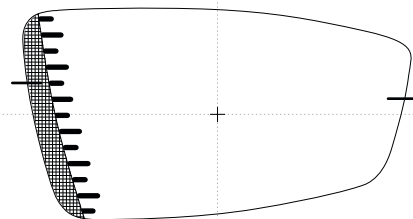

0,9 mm

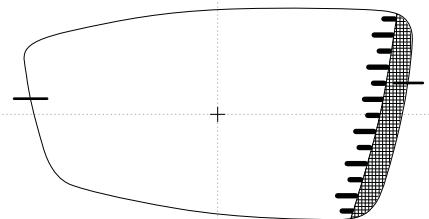

NIKOLAS

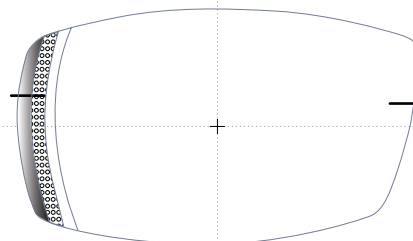

0,7 mm

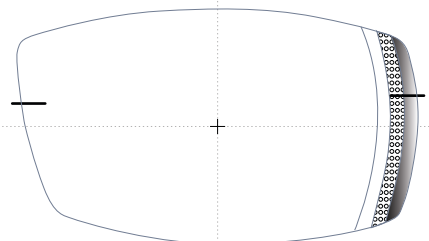



atelier
kreativ

NINA

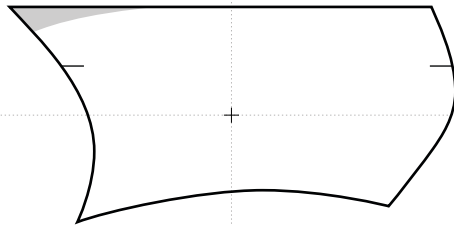

0,5 mm

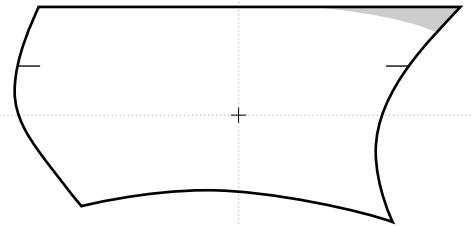

NITROGENA

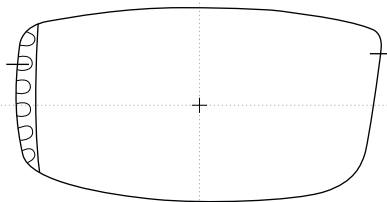

0 mm

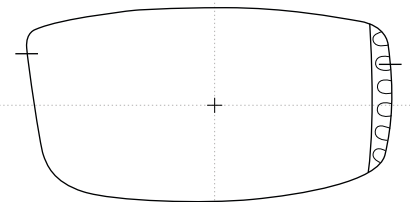

NORA

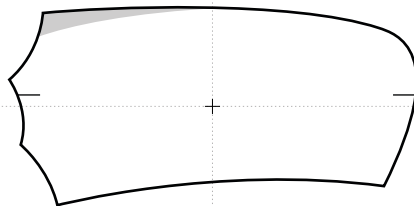

0 mm

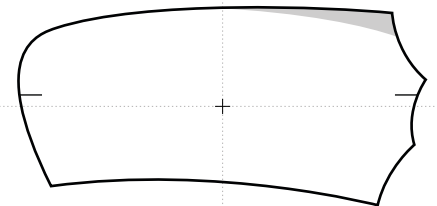

OLGA

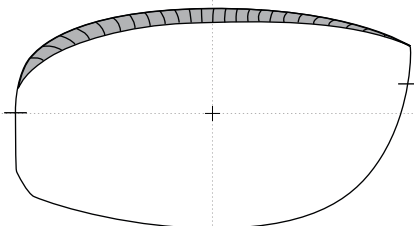

0 mm

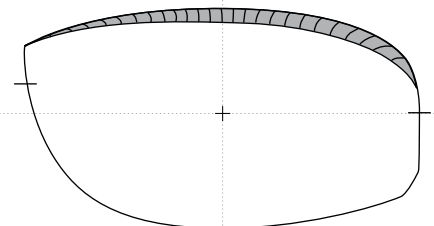

Tyto kreativní tvary brýlových čoček byly navrženy a vyrobeny v ateliéru kreativ při společnosti EYE 2000 s.r.o. a jsou chráněny Úřadem průmyslového vlastnictví jako průmyslový vzor.
These creative glasses lens shapes were designed and produced by atelier kreativ by EYE 2000 s.r.o. company and are patented and protected by the Authority of the Industrial Property.

EYE 2000 s.r.o. / Ohmova 271 / 109 00 Praha 10 / Czech Republic / Provozovna / Polubenská 614 / 468 61 Desná / Czech Republic
T +420 271 961 170 / www.eye2000.cz / info@eye2000.cz



ateliér
kreativ

OLIVER

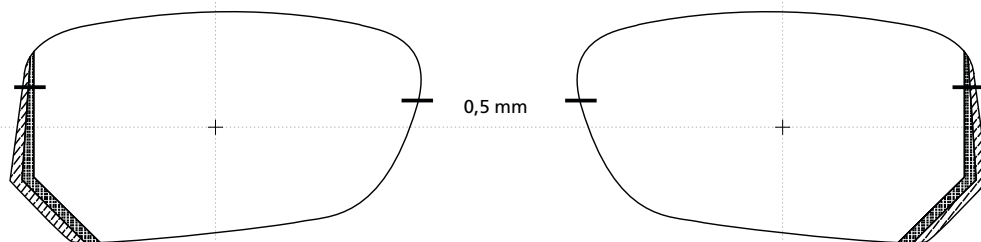

OLIVIE

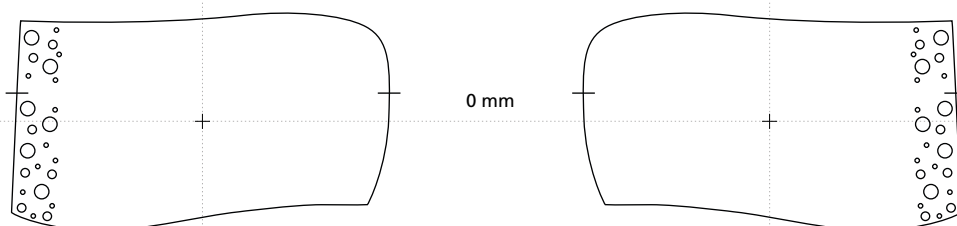

ONDRAS

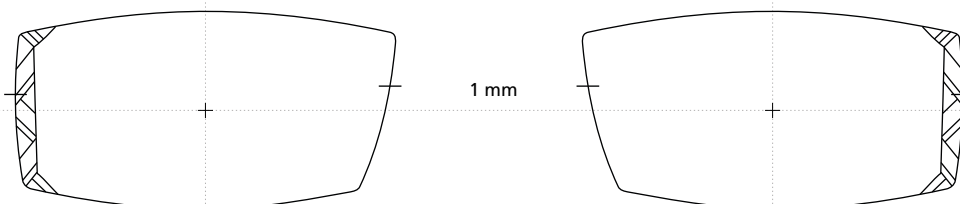

ORCHIDEJ

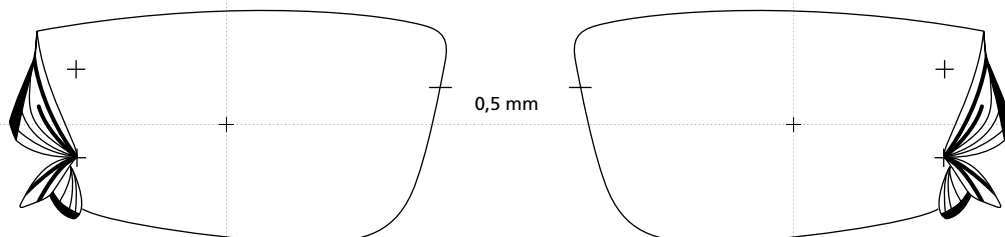

Tyto kreativní tvary brýlových čoček byly navrženy a vyrobeny v ateliéru kreativ při společnosti EYE 2000 s.r.o. a jsou chráněny Úřadem průmyslového vlastnictví jako průmyslový vzor.
These creative glasses lens shapes were designed and produced by ateliér kreativ by EYE 2000 s.r.o. company and are patented and protected by the Authority of the Industrial Property.

EYE 2000 s.r.o. / Ohmova 271 / 109 00 Praha 10 / Czech Republic / Provozovna / Polubenská 614 / 468 61 Desná / Czech Republic
T +420 271 961 170 / www.eye2000.cz / info@eye2000.cz



ateliér
kreativ

OSKAR

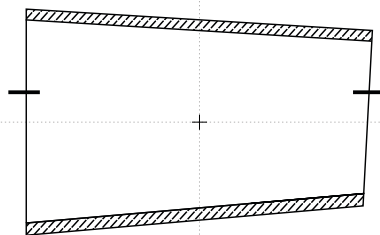

0,5 mm

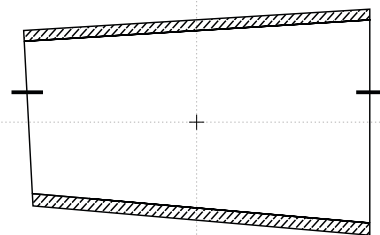

PALLADIA

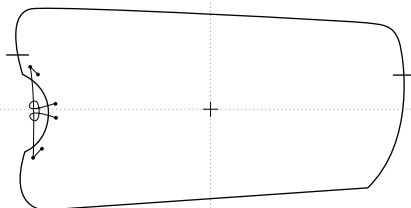

0 mm

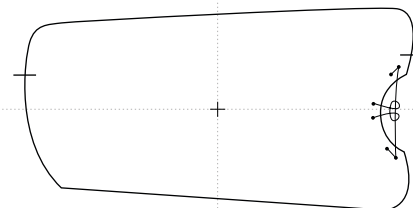

PALOMA

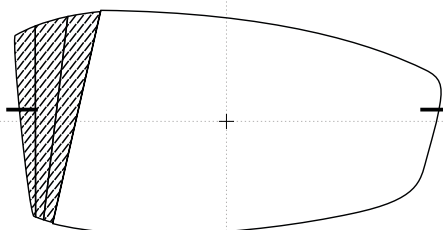

0,6 mm

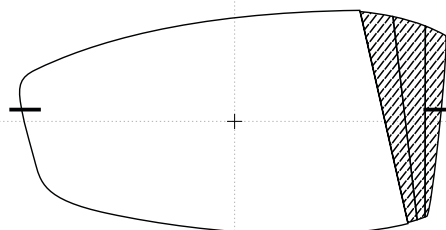

PANNA

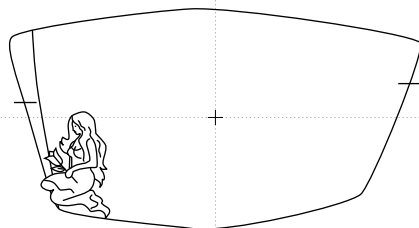

1,5 mm

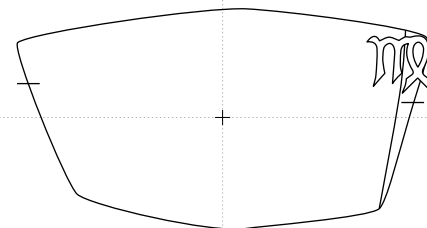

Tyto kreativní tvary brýlových čoček byly navrženy a vyrobeny v ateliéru kreativ při společnosti EYE 2000 s.r.o. a jsou chráněny Úřadem průmyslového vlastnictví jako průmyslový vzor. These creative glasses lens shapes were designed and produced by ateliér kreativ by EYE 2000 s.r.o. company and are patented and protected by the Authority of the Industrial Property.

EYE 2000 s.r.o. / Ohmova 271 / 109 00 Praha 10 / Czech Republic / Provozovna / Polubenská 614 / 468 61 Desná / Czech Republic
T +420 271 961 170 / www.eye2000.cz / info@eye2000.cz

PAT

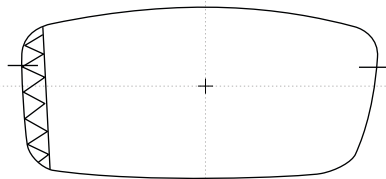

0 mm

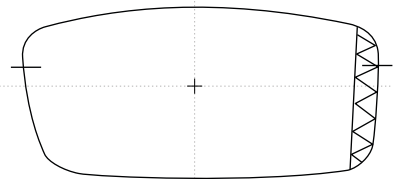

PATRICIE

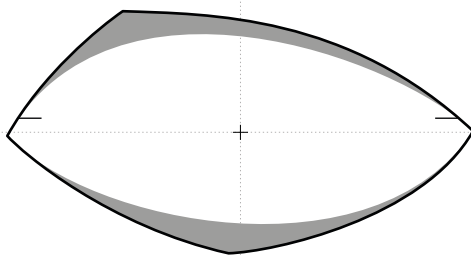

2 mm

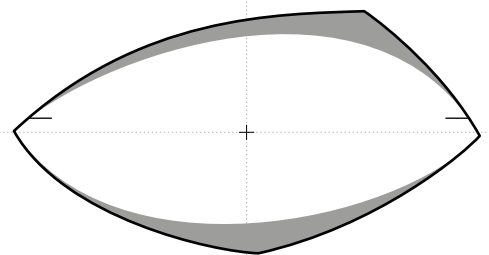

PATRIK

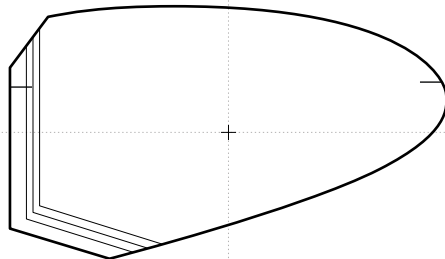

1 mm

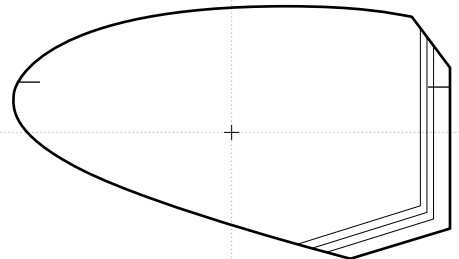

PAVEL

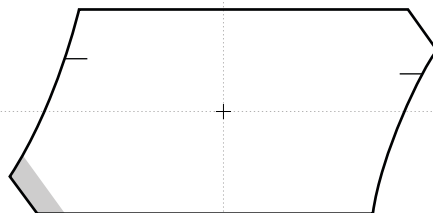

2 mm

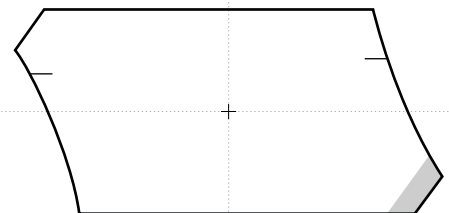

PAVLINKA

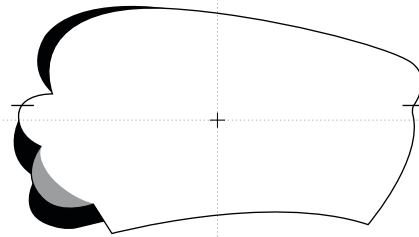

1 mm

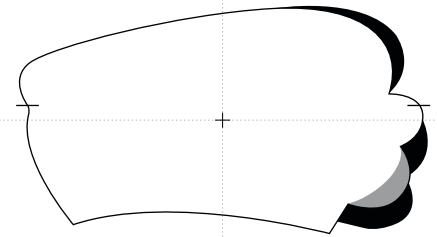

PENELOPA

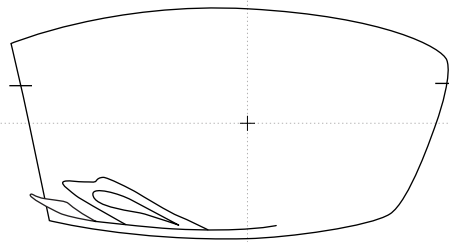

0,5 mm

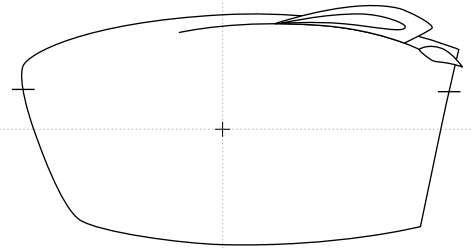

PEPITO

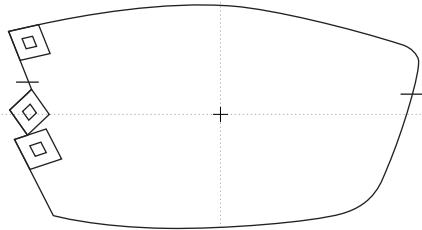

1 mm

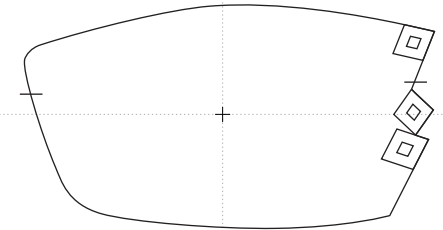

PERSIDA

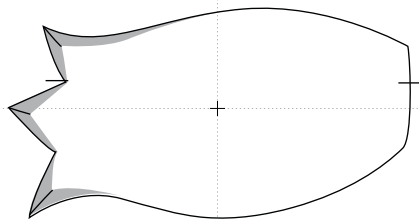

0 mm

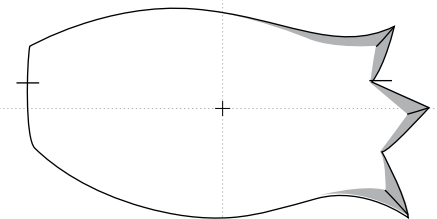

PETR

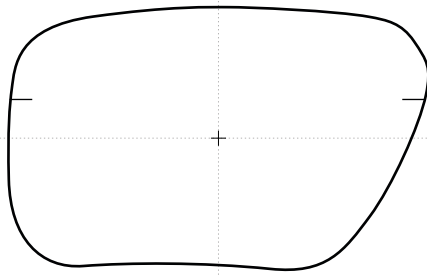

1 mm

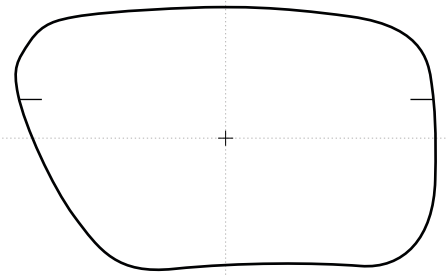

PHOSPHOREA

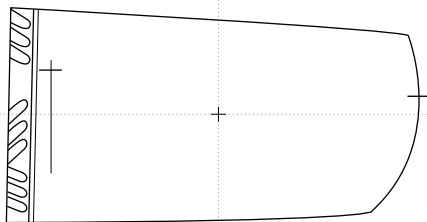

0 mm

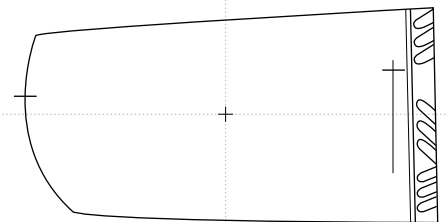

PLUTENIA

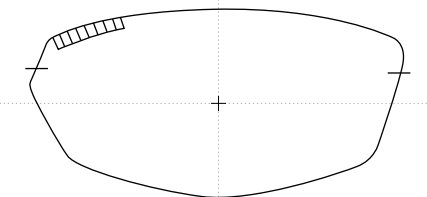

0,5 mm

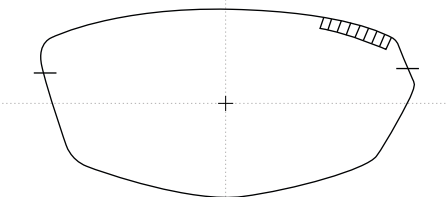

POLONIA

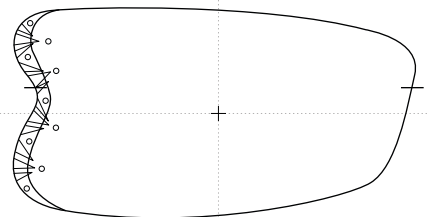

0,5 mm

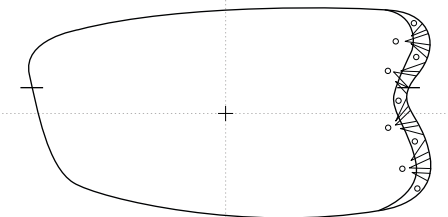

POPELKA

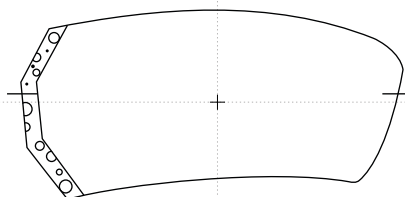

0,5 mm

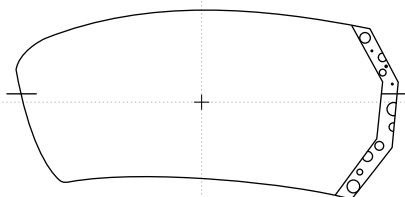

PRISCILA

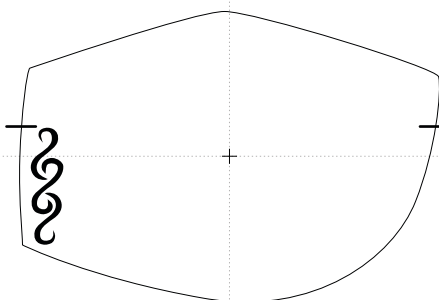

0,5 mm

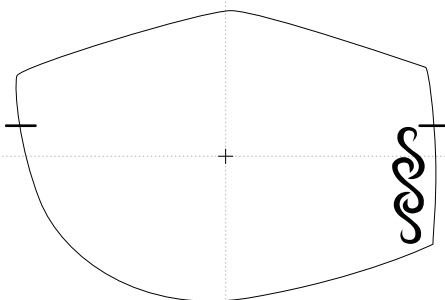

PROKOP

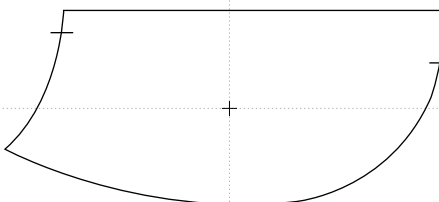

0,5 mm

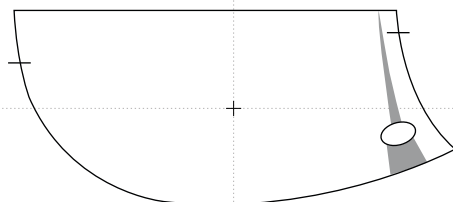

RADANA

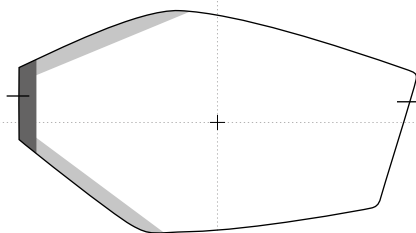

1 mm

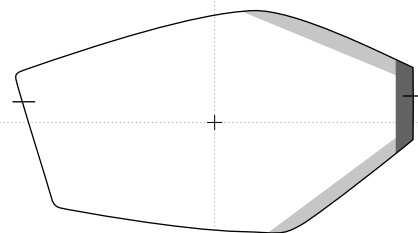



atelier
kreativ

RADEK

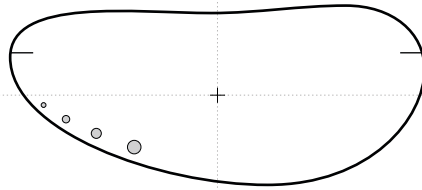

0,5 mm

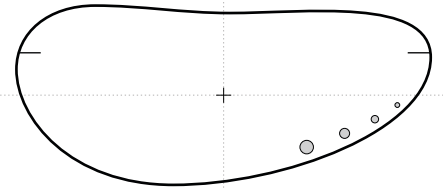

RADIANA

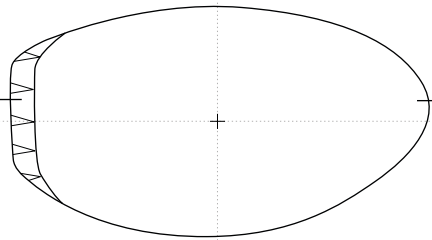

0 mm

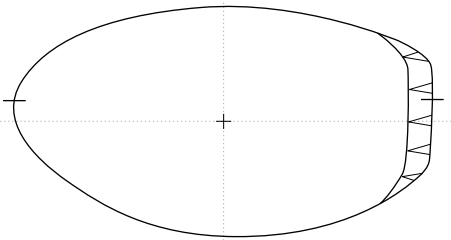

RADUZA

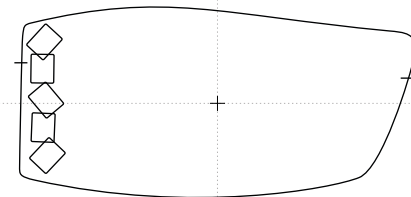

2 mm

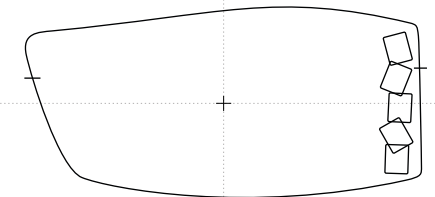

RAFAELA

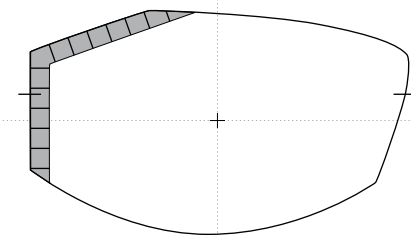

0,5 mm

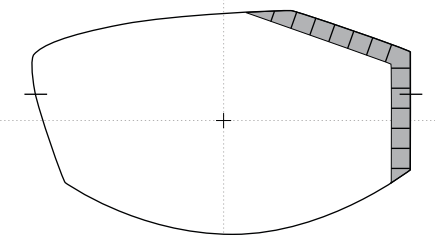

Tyto kreativní tvary brýlových čoček byly navrženy a vyrobeny v ateliéru kreativ při společnosti EYE 2000 s.r.o. a jsou chráněny Úřadem průmyslového vlastnictví jako průmyslový vzor.
These creative glasses lens shapes were designed and produced by atelier kreativ by EYE 2000 s.r.o. company and are patented and protected by the Authority of the Industrial Property.

EYE 2000 s.r.o. / Ohmova 271 / 109 00 Praha 10 / Czech Republic / Provozovna / Polubenská 614 / 468 61 Desná / Czech Republic
T +420 271 961 170 / www.eye2000.cz / info@eye2000.cz



ateliér
kreativ

RACHEL

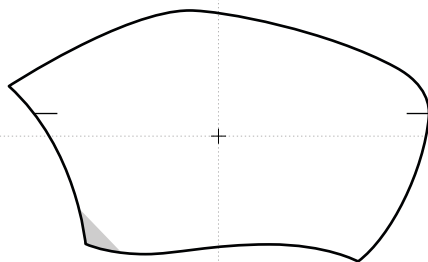

0 mm

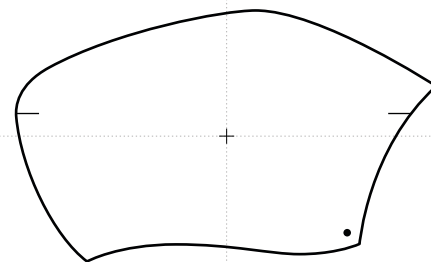

RAJSA

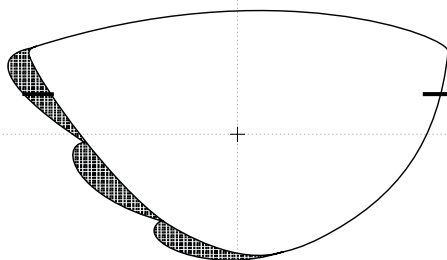

1,2 mm

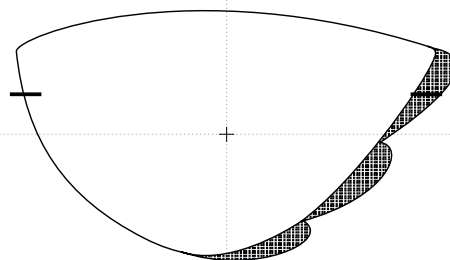

RAK

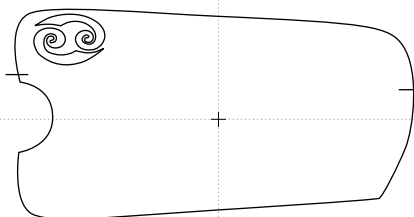

0 mm

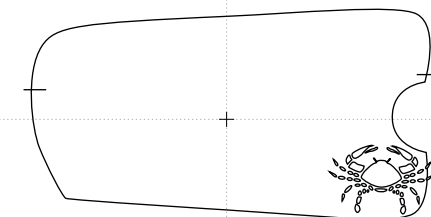

REGINA

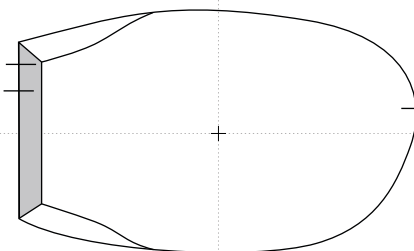

0 mm

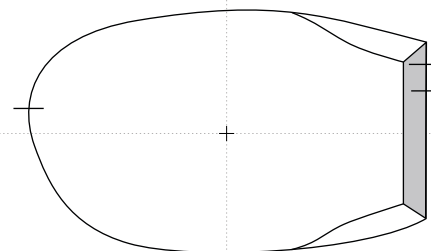

Tyto kreativní tvary brýlových čoček byly navrženy a vyrobeny v ateliéru kreativ při společnosti EYE 2000 s.r.o. a jsou chráněny Úřadem průmyslového vlastnictví jako průmyslový vzor.
These creative glasses lens shapes were designed and produced by ateliér kreativ by EYE 2000 s.r.o. company and are patented and protected by the Authority of the Industrial Property.

EYE 2000 s.r.o. / Ohmova 271 / 109 00 Praha 10 / Czech Republic / Provozovna / Polubenská 614 / 468 61 Desná / Czech Republic
T +420 271 961 170 / www.eye2000.cz / info@eye2000.cz



atelier
kreativ

REMUS

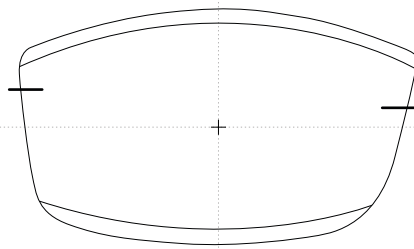

1,4 mm

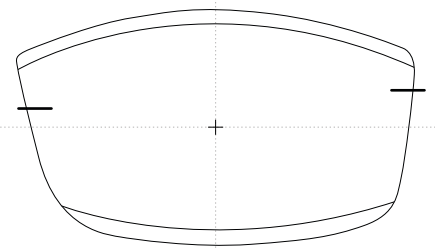

RENATA

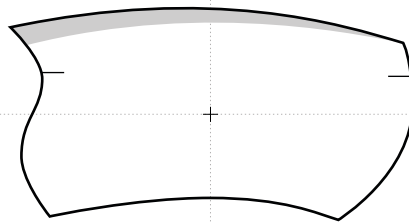

0,5 mm

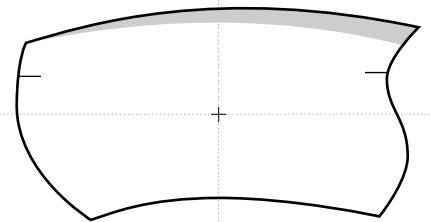

RICHARD

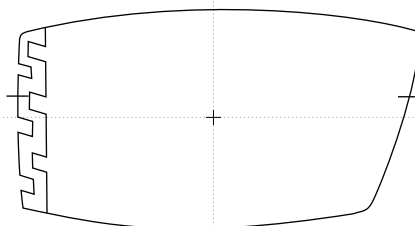

0,5 mm

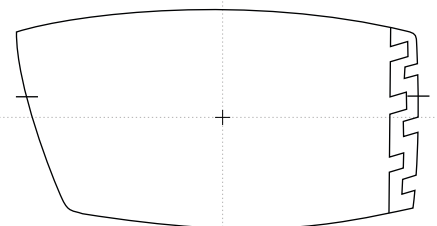

RIJANA

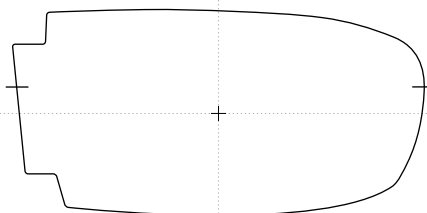

0,5 mm

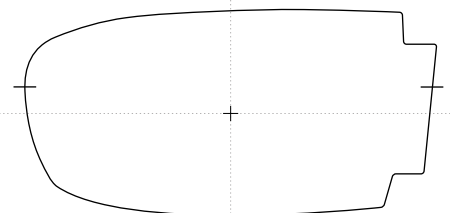

Tyto kreativní tvary brýlových čoček byly navrženy a vyrobeny v ateliéru kreativ při společnosti EYE 2000 s.r.o. a jsou chráněny Úřadem průmyslového vlastnictví jako průmyslový vzor.
These creative glasses lens shapes were designed and produced by atelier kreativ by EYE 2000 s.r.o. company and are patented and protected by the Authority of the Industrial Property.

EYE 2000 s.r.o. / Ohmova 271 / 109 00 Praha 10 / Czech Republic / Provozovna / Polubenská 614 / 468 61 Desná / Czech Republic
T +420 271 961 170 / www.eyeye2000.cz / info@eyeye2000.cz



ateliér
kreativ

ROBIN

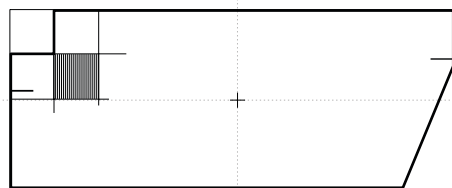

0 mm

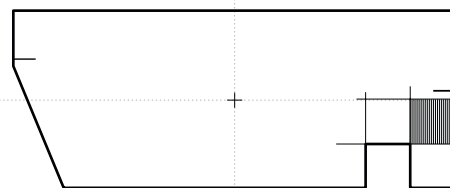

ROMANA

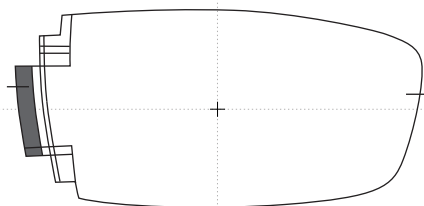

0,5 mm

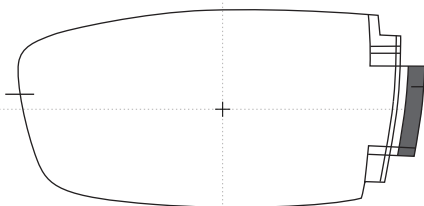

ROSAMUNDA

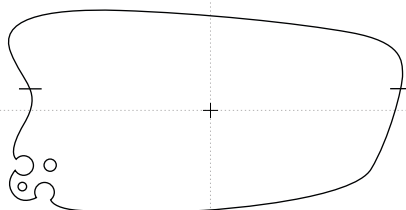

0,5 mm

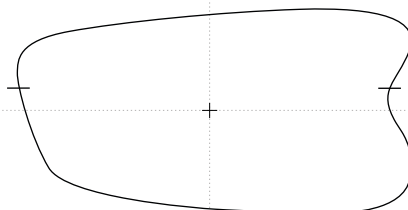

ROZARKA

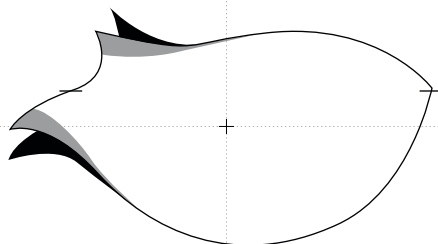

0 mm

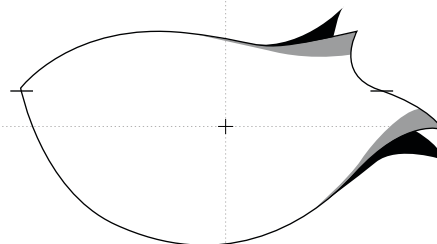

Tyto kreativní tvary brýlových čoček byly navrženy a vyrobeny v ateliéru kreativ při společnosti EYE 2000 s.r.o. a jsou chráněny Úřadem průmyslového vlastnictví jako průmyslový vzor.
These creative glasses lens shapes were designed and produced by ateliér kreativ by EYE 2000 s.r.o. company and are patented and protected by the Authority of the Industrial Property.

EYE 2000 s.r.o. / Ohmova 271 / 109 00 Praha 10 / Czech Republic / Provozovna / Polubenská 614 / 468 61 Desná / Czech Republic
T +420 271 961 170 / www.eye2000.cz / info@eye2000.cz

ROZITA

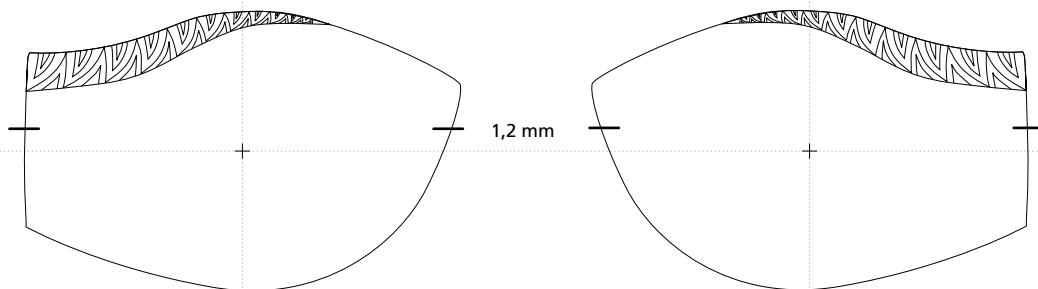

RUBI

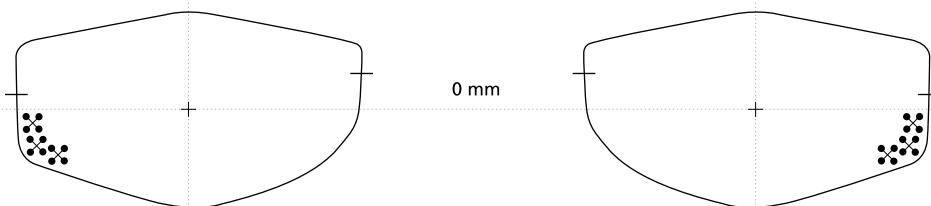

RUFIN

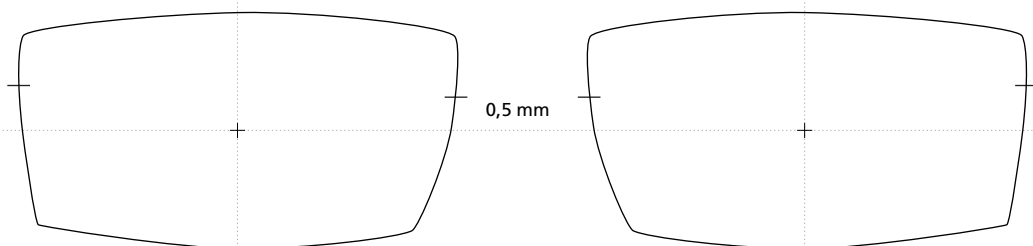

RUT

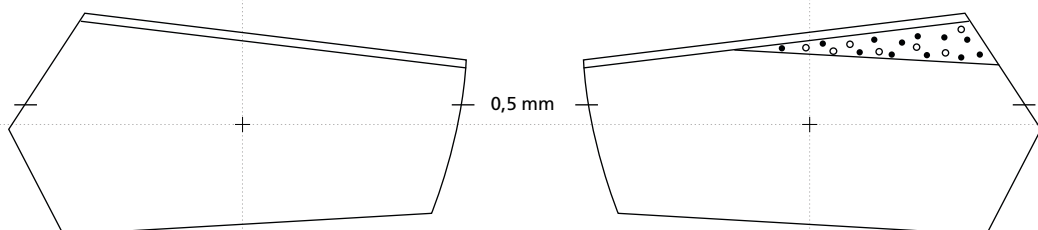



ateliér
kreativ

RYBY

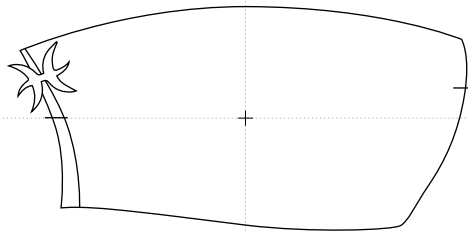

0 mm

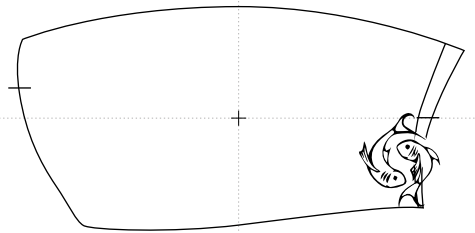

SABINA

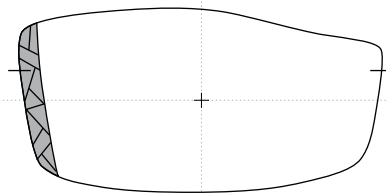

0 mm

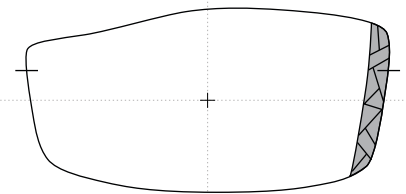

SALOMENA

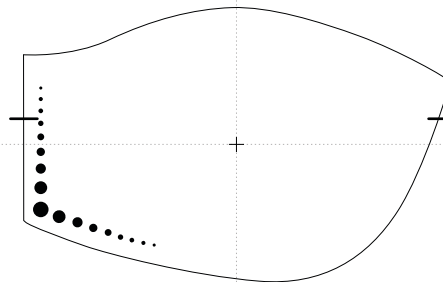

1,4 mm

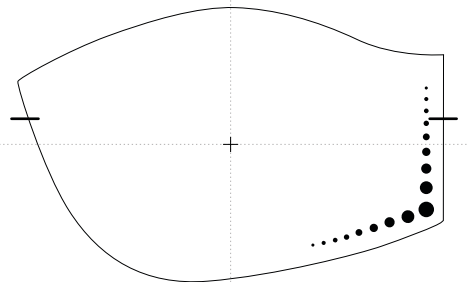

SAMARA

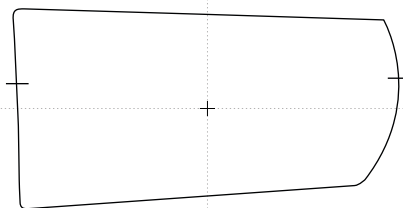

0 mm

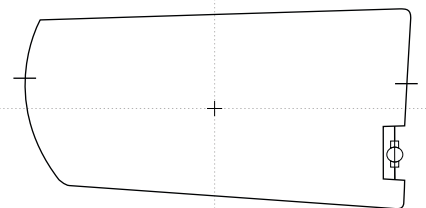

Tyto kreativní tvary brýlových čoček byly navrženy a vyrobeny v ateliéru kreativ při společnosti EYE 2000 s.r.o. a jsou chráněny Úřadem průmyslového vlastnictví jako průmyslový vzor.
These creative glasses lens shapes were designed and produced by ateliér kreativ by EYE 2000 s.r.o. company and are patented and protected by the Authority of the Industrial Property.

EYE 2000 s.r.o. / Ohmova 271 / 109 00 Praha 10 / Czech Republic / Provozovna / Polubenská 614 / 468 61 Desná / Czech Republic
T +420 271 961 170 / www.eye2000.cz / info@eye2000.cz

SANDRA

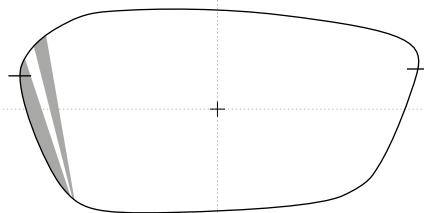

0,25 mm

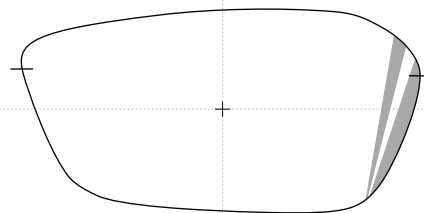

SASKIE

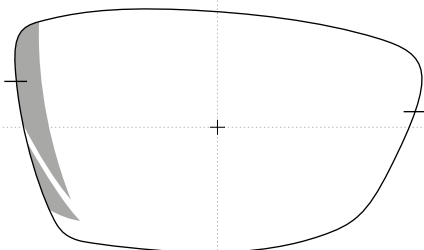

1 mm

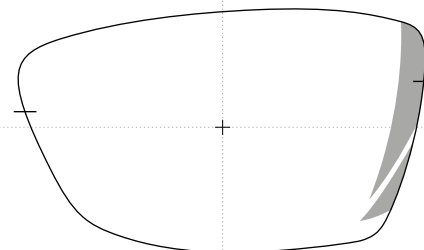

SAVA

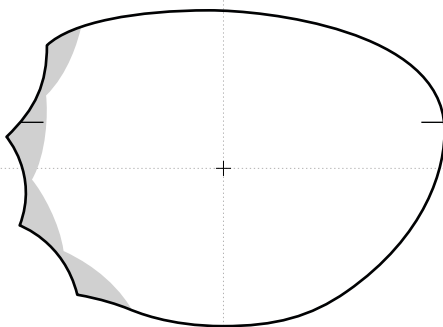

0 mm

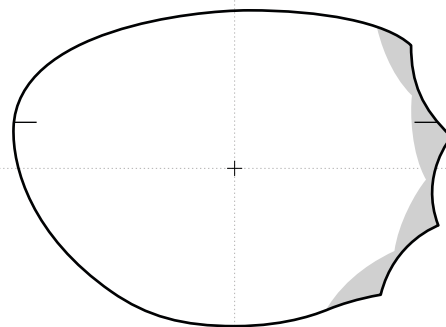

SEDMIKRASKA

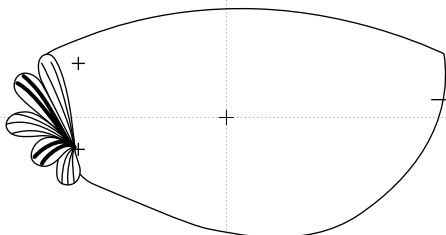

0 mm

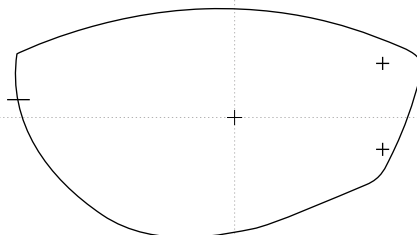



atelier
kreativ

SEDRİK

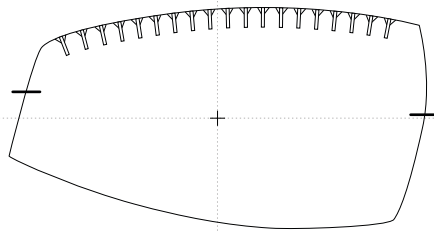

0 mm

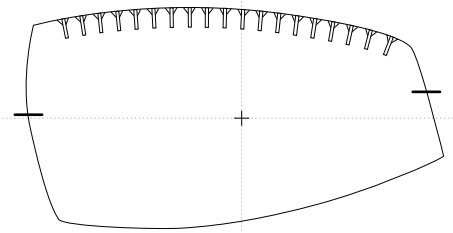

SELENA

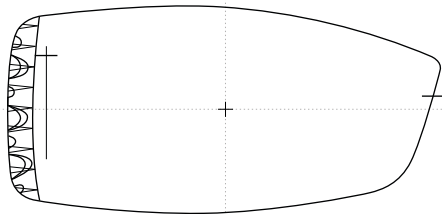

1 mm

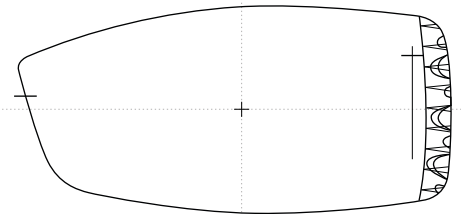

SHARK

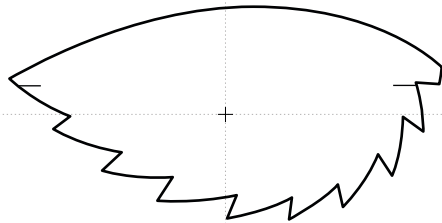

3 mm

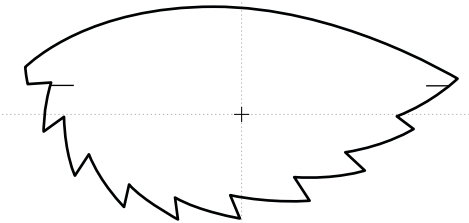

SILICA

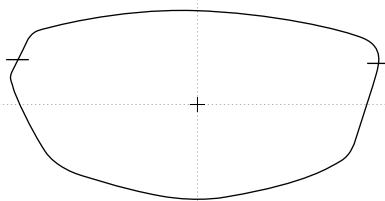

0 mm

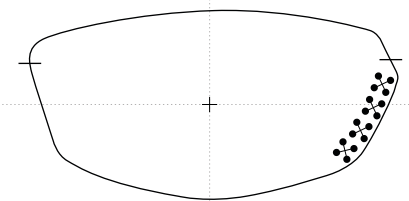

Tyto kreativní tvary brýlových čoček byly navrženy a vyrobeny v ateliéru kreativ při společnosti EYE 2000 s.r.o. a jsou chráněny Úřadem průmyslového vlastnictví jako průmyslový vzor.
These creative glasses lens shapes were designed and produced by atelier kreativ by EYE 2000 s.r.o. company and are patented and protected by the Authority of the Industrial Property.

EYE 2000 s.r.o. / Ohmova 271 / 109 00 Praha 10 / Czech Republic / Provozovna / Polubenská 614 / 468 61 Desná / Czech Republic
T +420 271 961 170 / www.eye2000.cz / info@eye2000.cz



ateliér
kreativ

SIMIR

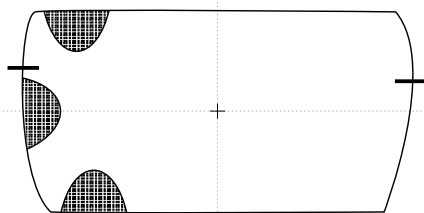

0 mm

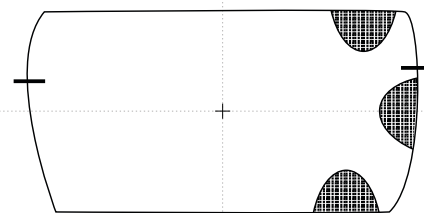

SIMONA

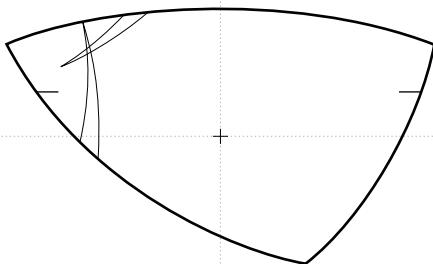

2 mm

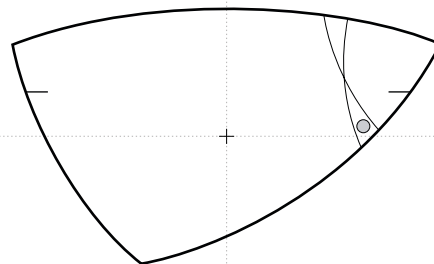

SLAVA

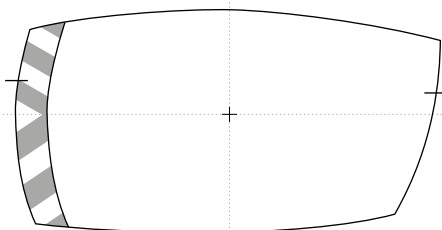

0,25 mm

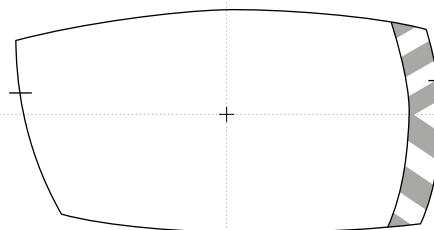

SONA

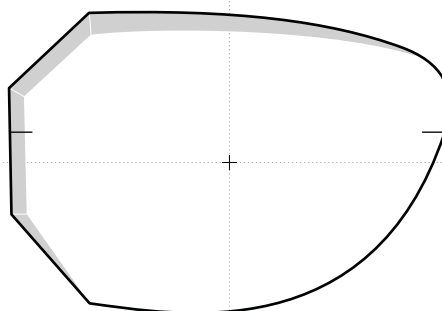

1 mm

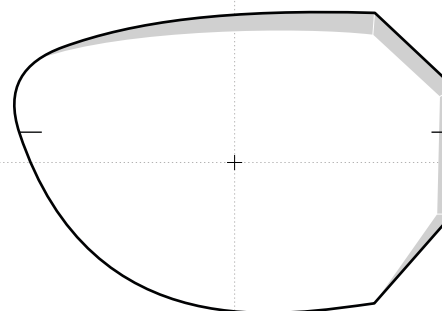

Tyto kreativní tvary brýlových čoček byly navrženy a vyrobeny v ateliéru kreativ při společnosti EYE 2000 s.r.o. a jsou chráněny Úřadem průmyslového vlastnictví jako průmyslový vzor. These creative glasses lens shapes were designed and produced by ateliér kreativ by EYE 2000 s.r.o. company and are patented and protected by the Authority of the Industrial Property.

EYE 2000 s.r.o. / Ohmova 271 / 109 00 Praha 10 / Czech Republic / Provozovna / Polubenská 614 / 468 61 Desná / Czech Republic
T +420 271 961 170 / www.eye2000.cz / info@eye2000.cz

SOPHIA

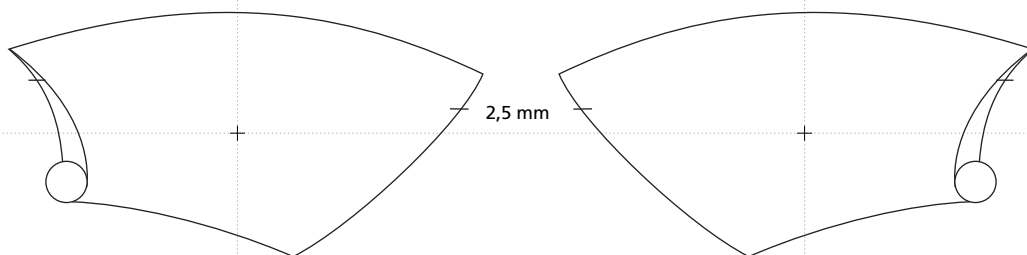

SPIRALY

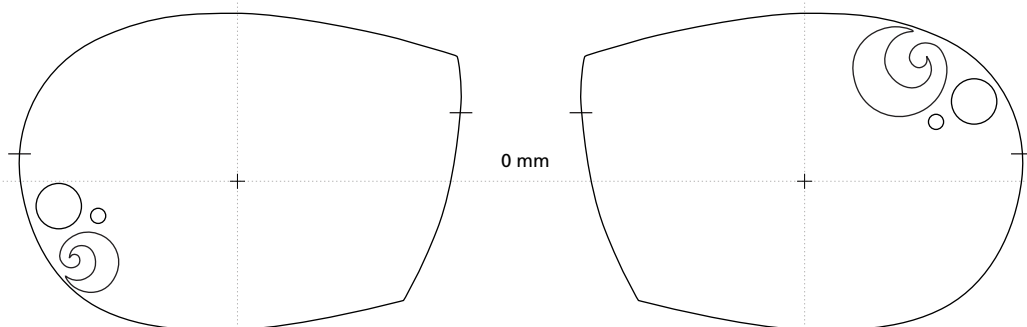

SPIRALY SUN

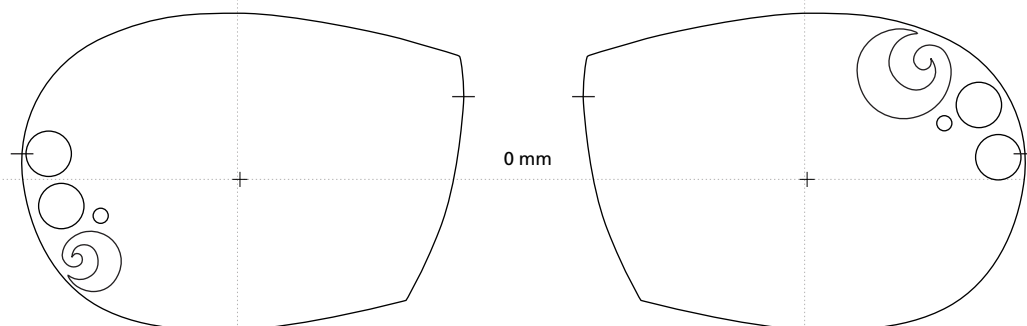

STRONCIA

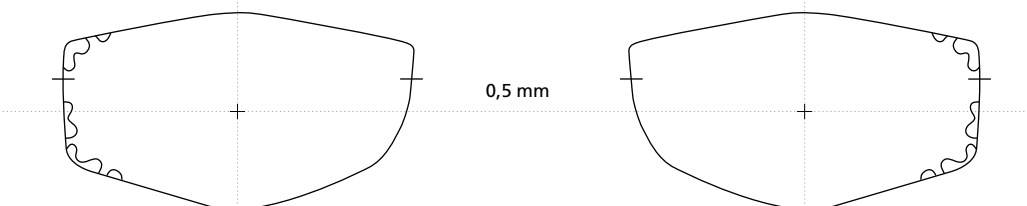

STŘELEC

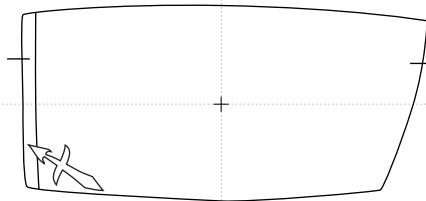

0,5 mm

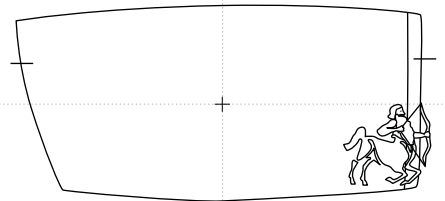

SVATAVA

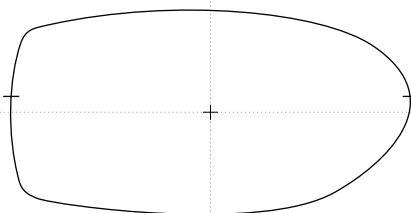

0 mm

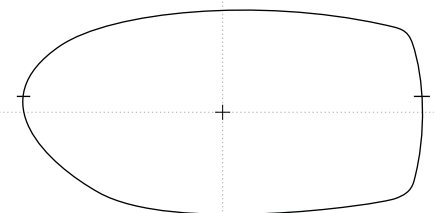

SVETLANA

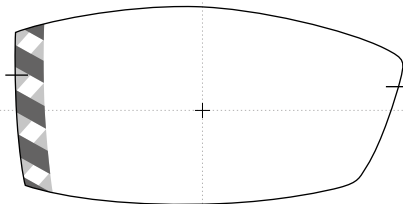

0,5 mm

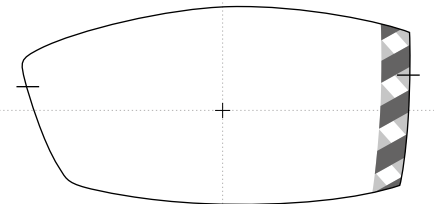

SAKIRA

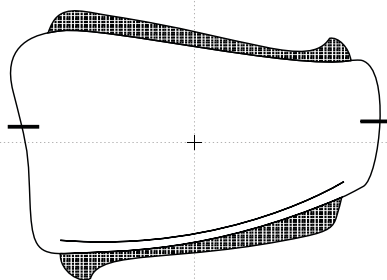

0 mm

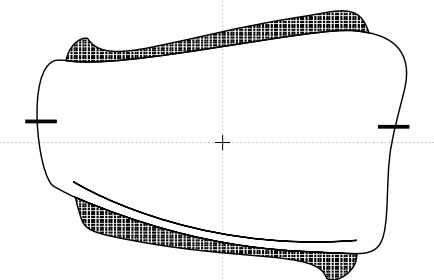



ateliér
kreativ

SARKA

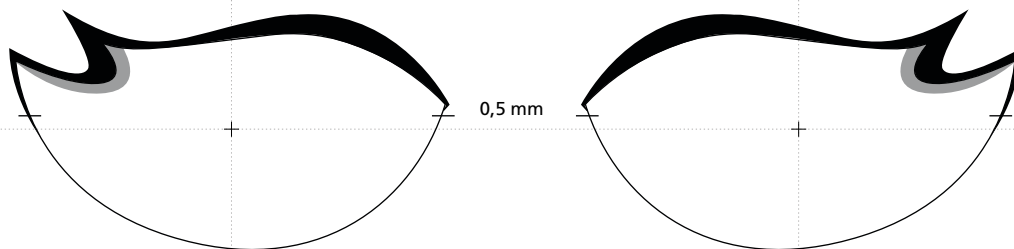

SARLOTA

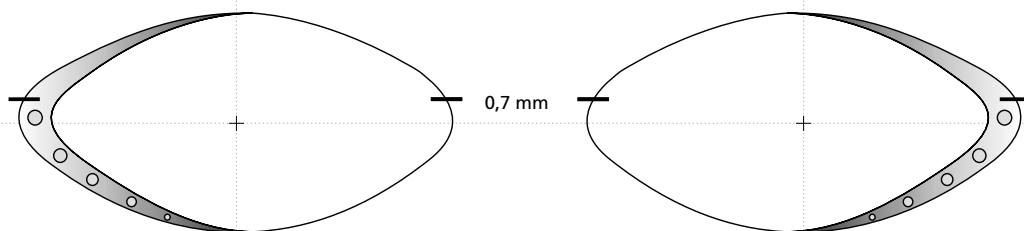

STIR

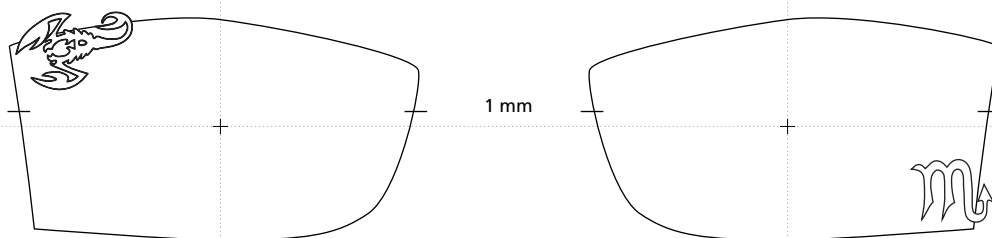

TADEAS

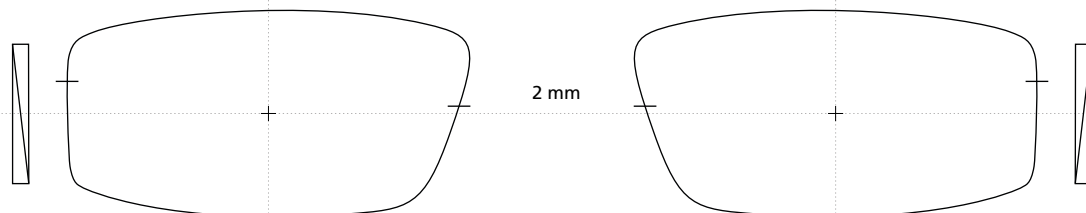

Tyto kreativní tvary brýlových čoček byly navrženy a vyrobeny v ateliéru kreativ při společnosti EYE 2000 s.r.o. a jsou chráněny Úřadem průmyslového vlastnictví jako průmyslový vzor.
These creative glasses lens shapes were designed and produced by ateliér kreativ by EYE 2000 s.r.o. company and are patented and protected by the Authority of the Industrial Property.

EYE 2000 s.r.o. / Ohmova 271 / 109 00 Praha 10 / Czech Republic / Provozovna / Polubenská 614 / 468 61 Desná / Czech Republic
T +420 271 961 170 / www.eye2000.cz / info@eye2000.cz

TAMARA

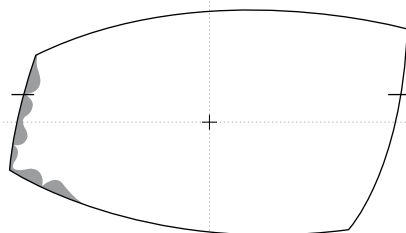

0,5 mm

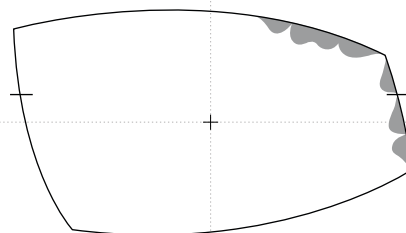

TATTOO ANDEL

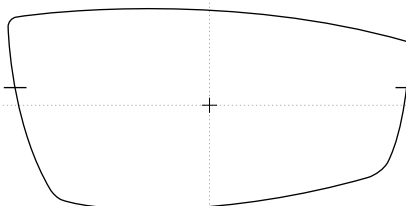

0,5 mm

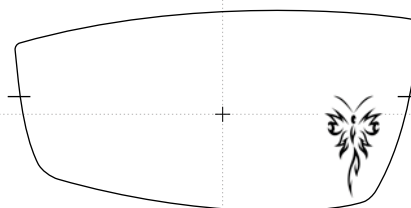

TATTOO DRAK

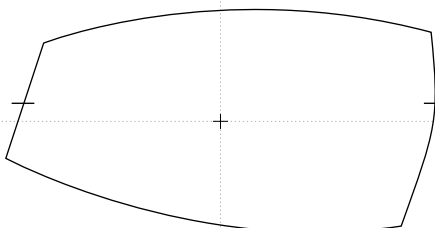

0,5 mm

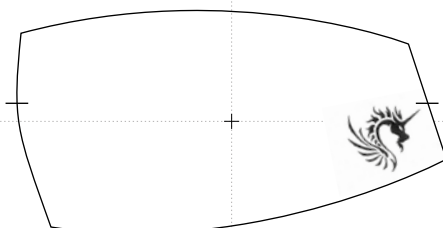

TATTOO DYKA

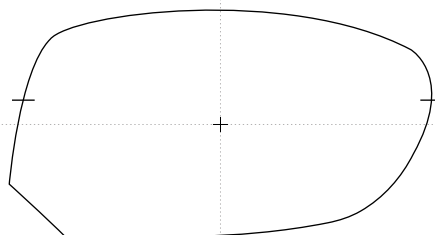

0 mm

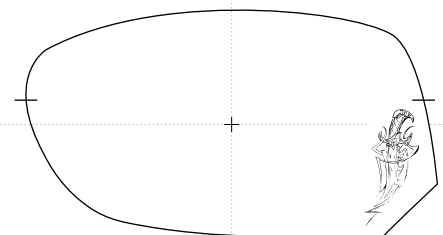

TATTOO GEISHA

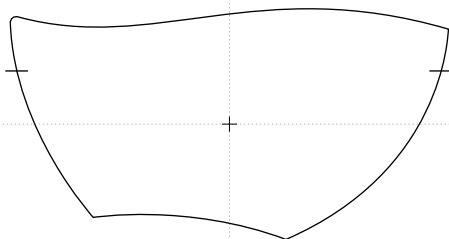

1 mm

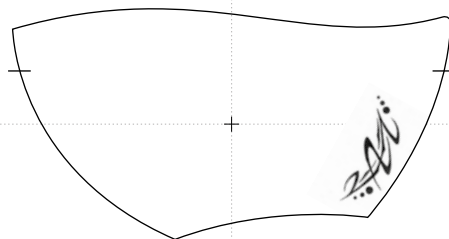

TATTOO HAD

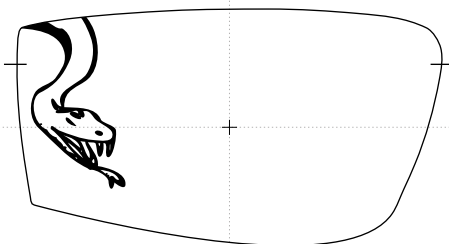

1 mm

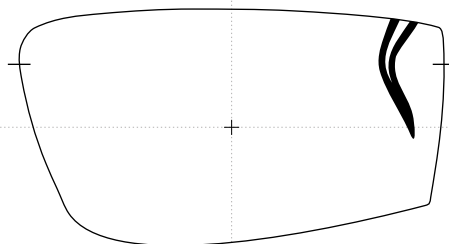

TATTOO JARO

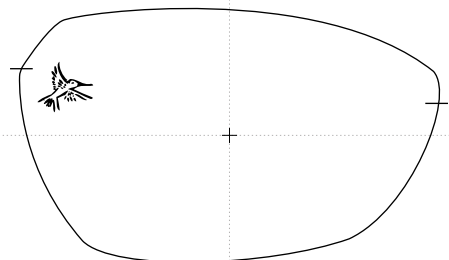

0,25 mm

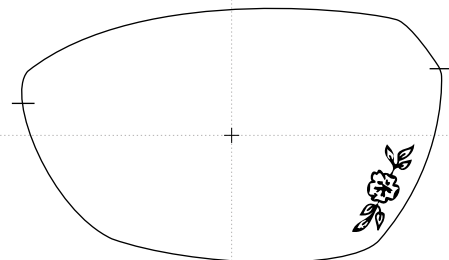

TATTOO JESTERKA

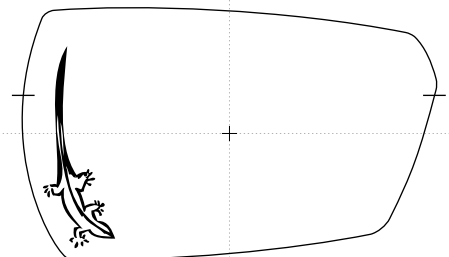

0 mm

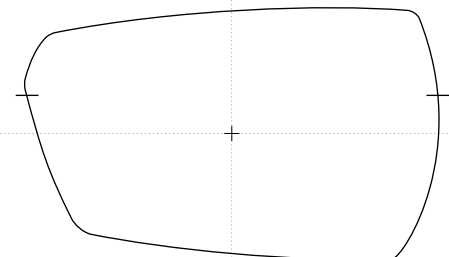

TATTOO KERKA

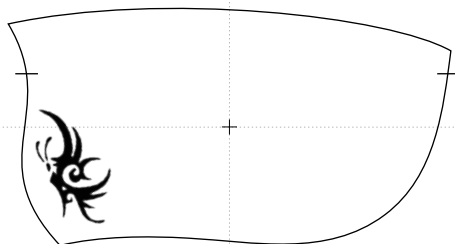

1 mm

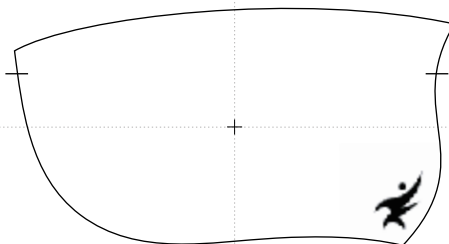

TATTOO KYTKA

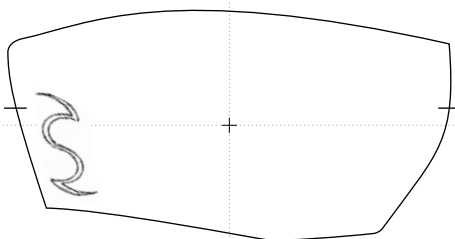

0 mm

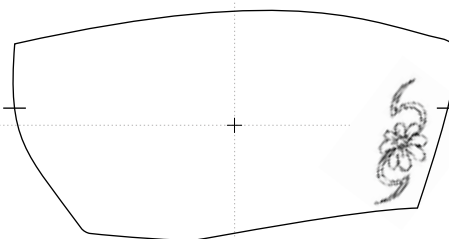

TATTOO MAHON

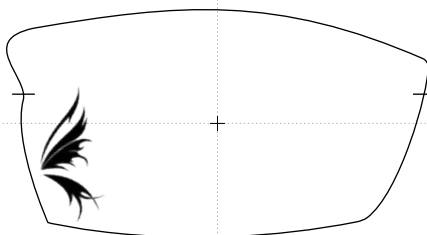

0,5 mm

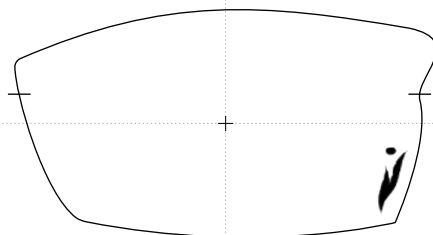

TATTOO MARIHUANA

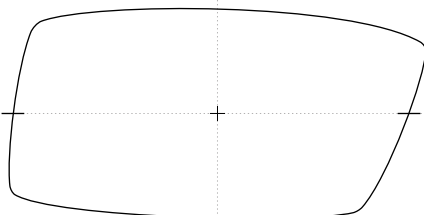

1 mm

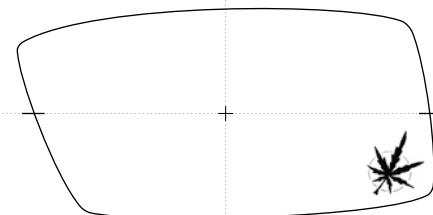

TATTOO OHEN

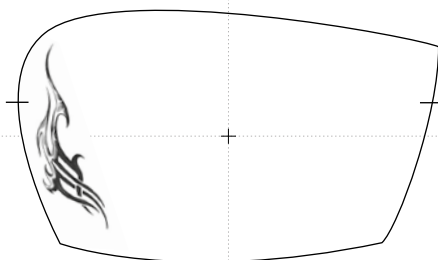

1 mm

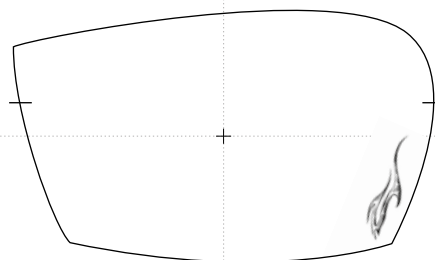

TATTOO PAVOUCEK

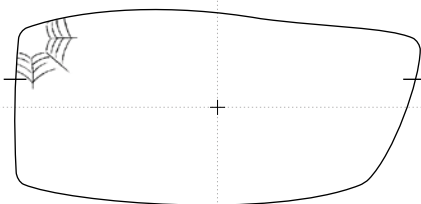

1 mm

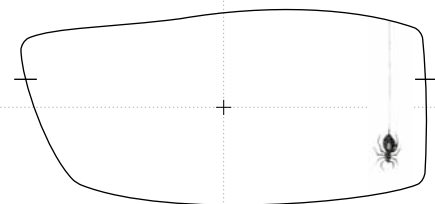

TATTOO SMRTAK

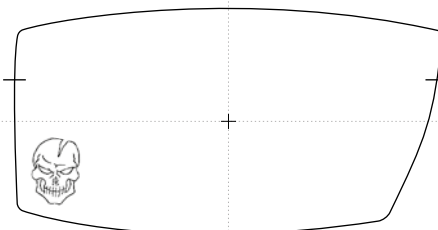

0,1 mm

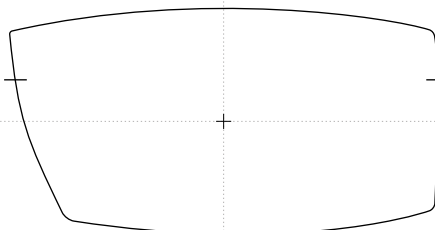

TATTOO SIPEK

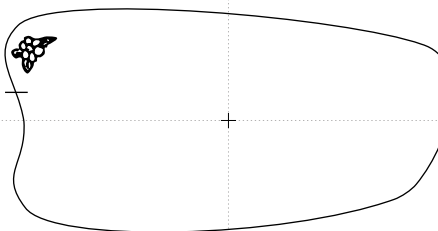

0 mm

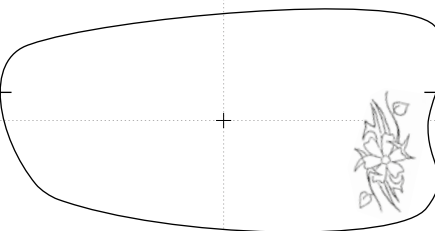

TATTOO TRILOBIT

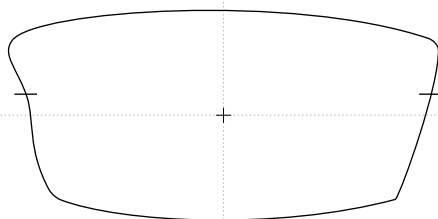

0,5 mm

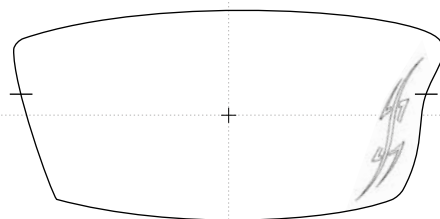

TAZ

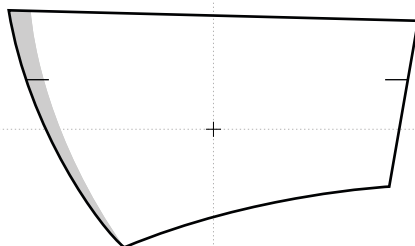

1,5 mm

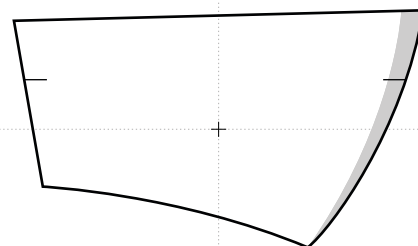

TEODORA

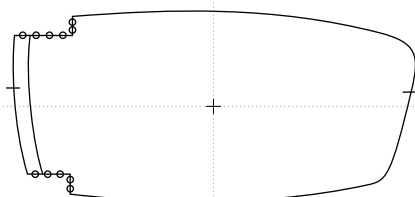

1 mm

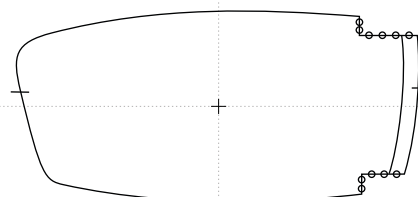

TEREZKA

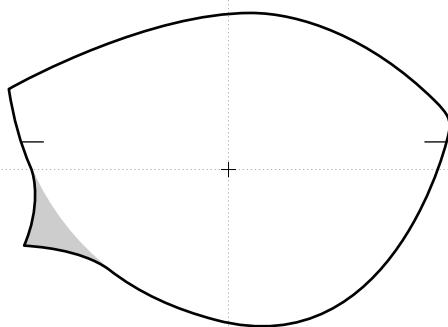

1 mm

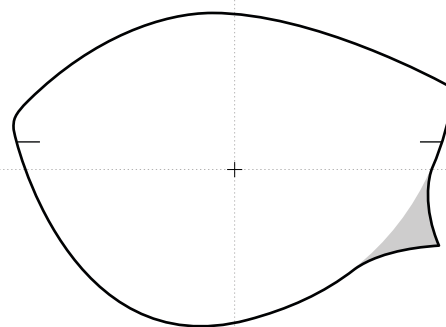



atelier
kreativ

THOREA

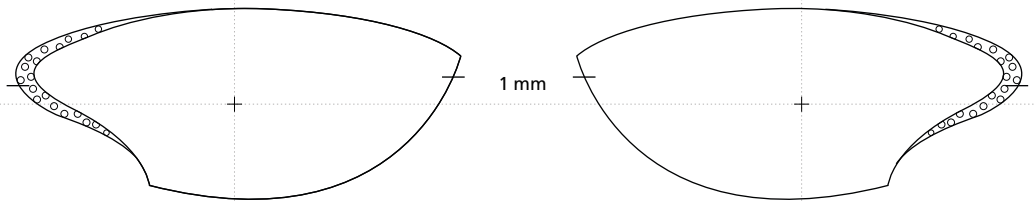

THULIA

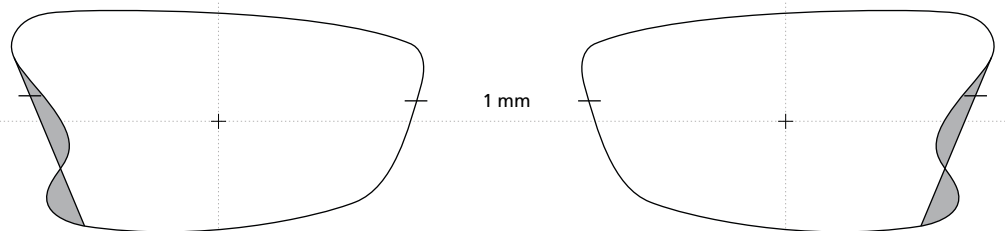

TITANA

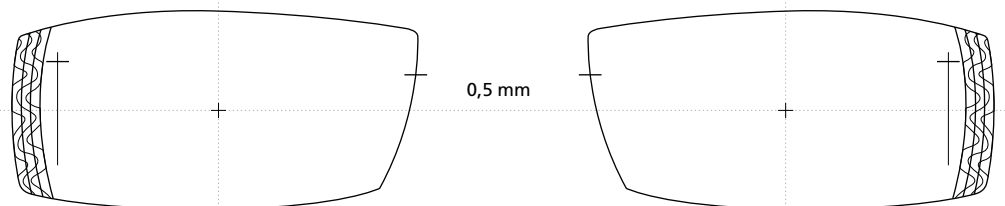

TOMISLAVA

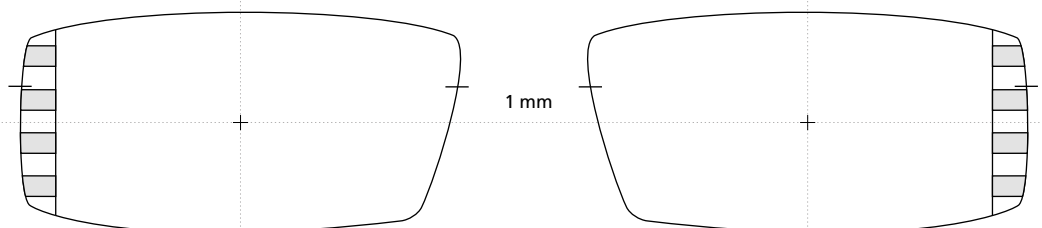

Tyto kreativní tvary brýlových čoček byly navrženy a vyrobeny v ateliéru kreativ při společnosti EYE 2000 s.r.o. a jsou chráněny Úřadem průmyslového vlastnictví jako průmyslový vzor.
These creative glasses lens shapes were designed and produced by atelier kreativ by EYE 2000 s.r.o. company and are patented and protected by the Authority of the Industrial Property.

EYE 2000 s.r.o. / Ohmova 271 / 109 00 Praha 10 / Czech Republic / Provozovna / Polubenská 614 / 468 61 Desná / Czech Republic
T +420 271 961 170 / www.eye2000.cz / info@eye2000.cz

TOSKA

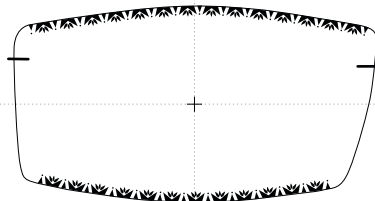

0 mm

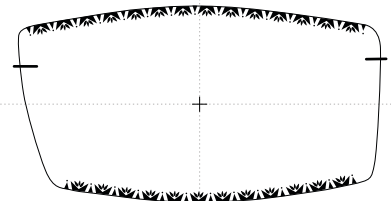

TRAVA

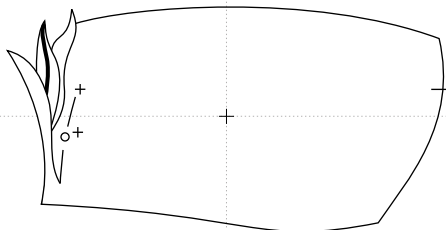

0 mm

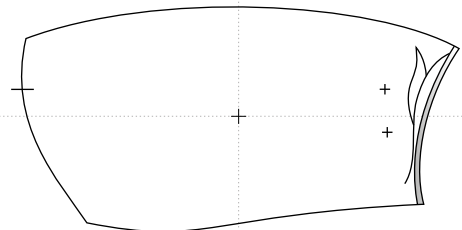

TRIDIA

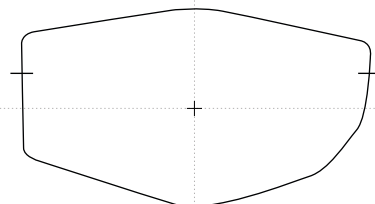

0,5 mm

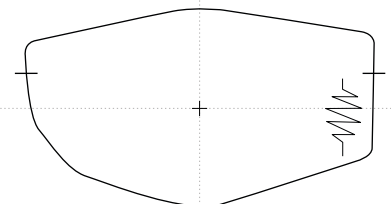

TULIPAN

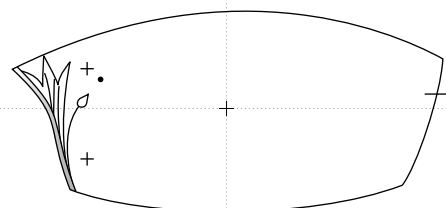

0,5 mm

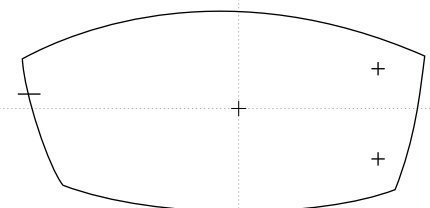



ateliér
kreativ

URANIA

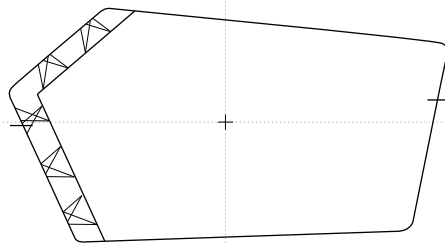

1,5 mm

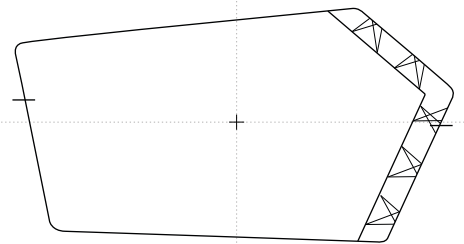

VAHY

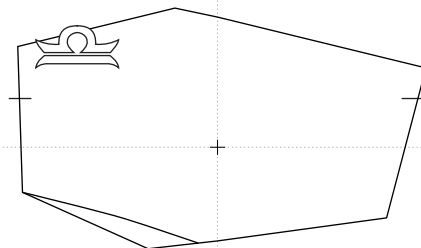

1 mm

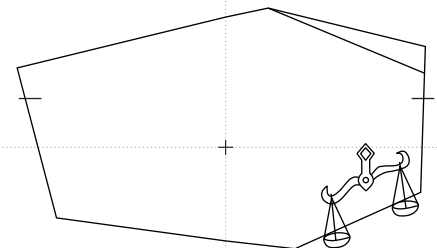

VALERIE

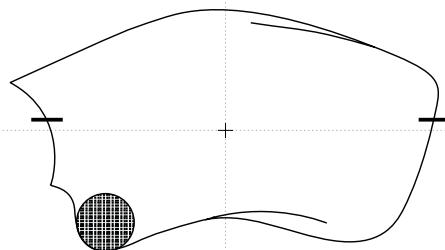

0,5 mm

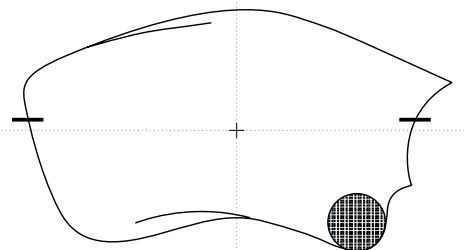

VANDA

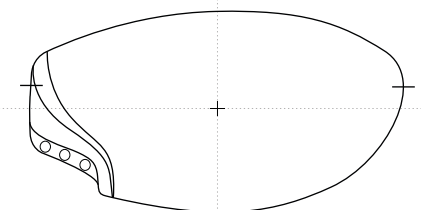

0 mm

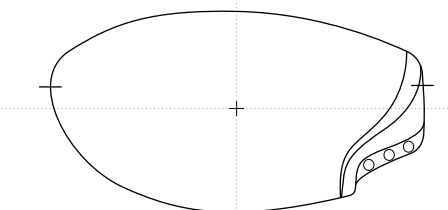

Tyto kreativní tvary brýlových čoček byly navrženy a vyrobeny v ateliéru kreativ při společnosti EYE 2000 s.r.o. a jsou chráněny Úřadem průmyslového vlastnictví jako průmyslový vzor.
These creative glasses lens shapes were designed and produced by ateliér kreativ by EYE 2000 s.r.o. company and are patented and protected by the Authority of the Industrial Property.

EYE 2000 s.r.o. / Ohmova 271 / 109 00 Praha 10 / Czech Republic / Provozovna / Polubenská 614 / 468 61 Desná / Czech Republic
T +420 271 961 170 / www.eye2000.cz / info@eye2000.cz

VANESA

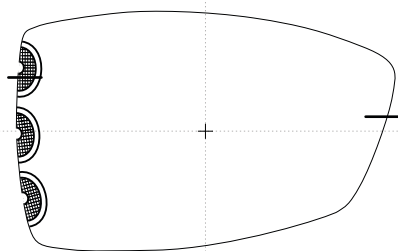

1 mm

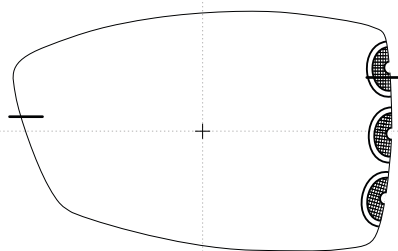

VECERNICE

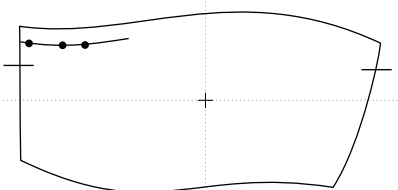

0,5 mm

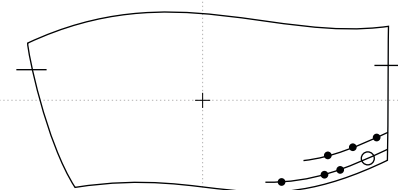

VENDULKA

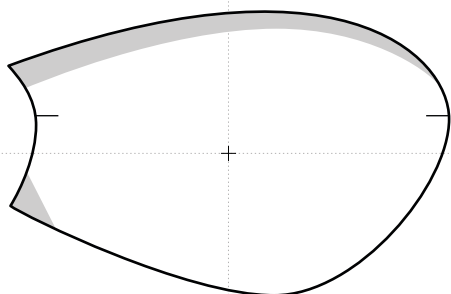

0 mm

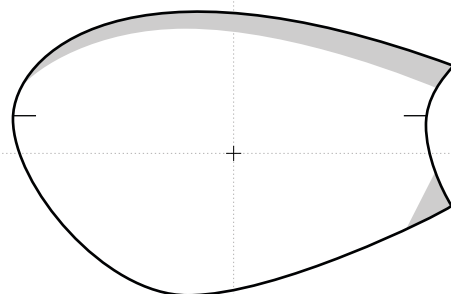

VERUNKA

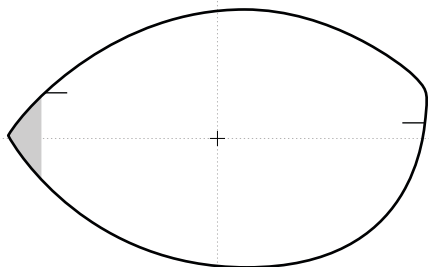

0,5 mm

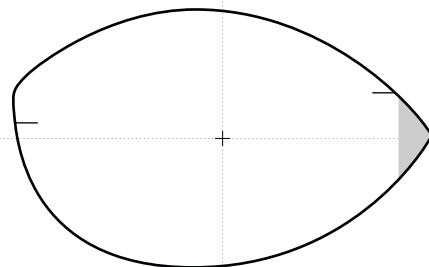



atelier
kreativ

VIKTORIE

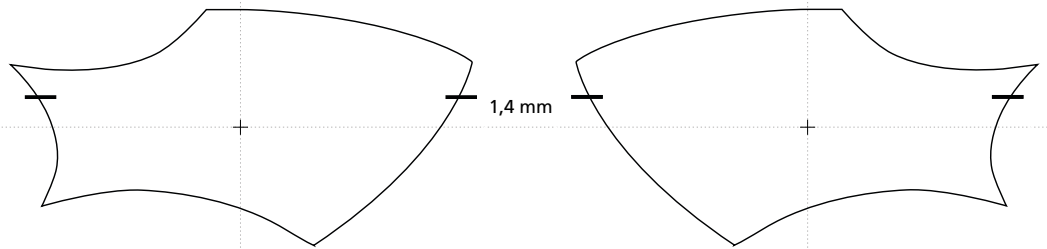

VILEMINA

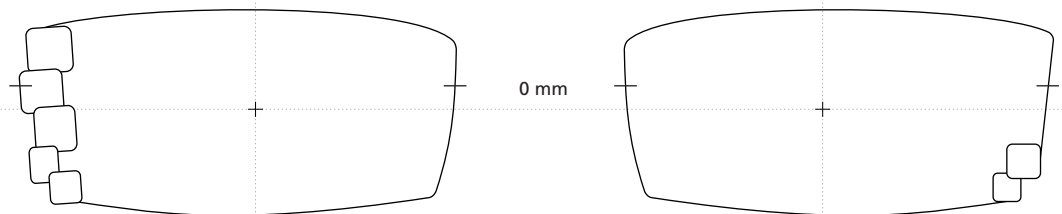

VINCENT

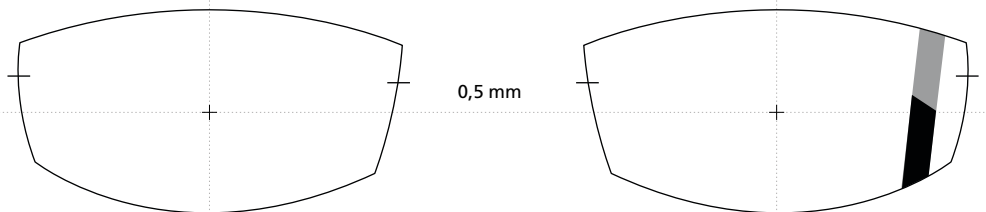

VIOLA

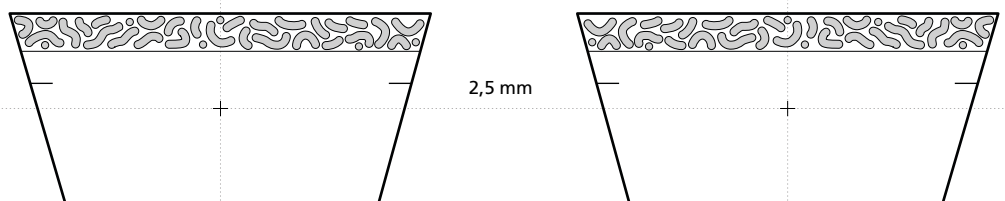

Tyto kreativní tvary brýlových čoček byly navrženy a vyrobeny v ateliéru kreativ při společnosti EYE 2000 s.r.o. a jsou chráněny Úřadem průmyslového vlastnictví jako průmyslový vzor. These creative glasses lens shapes were designed and produced by atelier kreativ by EYE 2000 s.r.o. company and are patented and protected by the Authority of the Industrial Property.

EYE 2000 s.r.o. / Ohmova 271 / 109 00 Praha 10 / Czech Republic / Provozovna / Polubenská 614 / 468 61 Desná / Czech Republic
T +420 271 961 170 / www.eye2000.cz / info@eye2000.cz

VIT

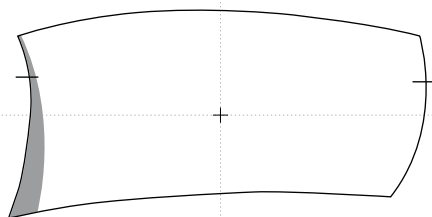

0 mm

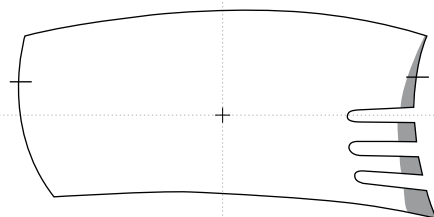

VODNAR

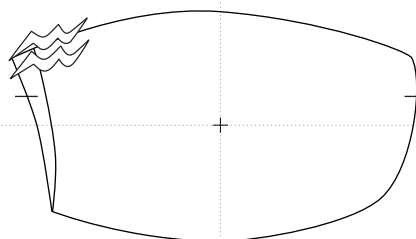

0 mm

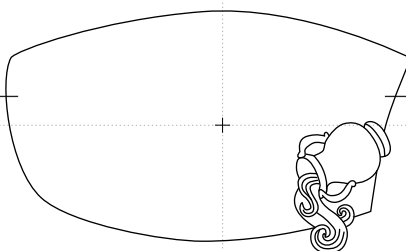

VOJTECH

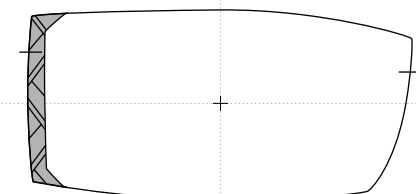

0 mm

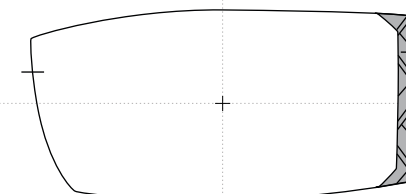

WALDEMAR

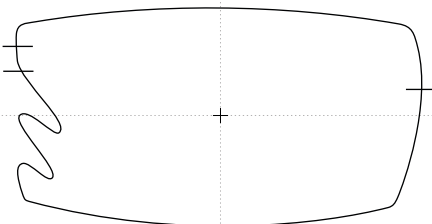

0 mm

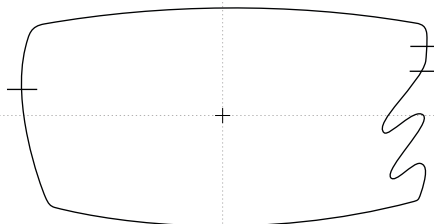

WOLF

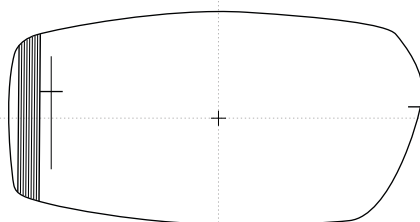

0,5 mm

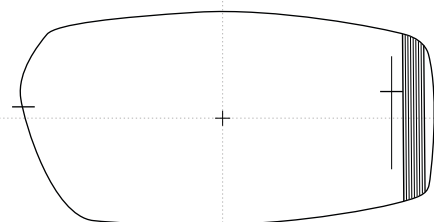

XENIE

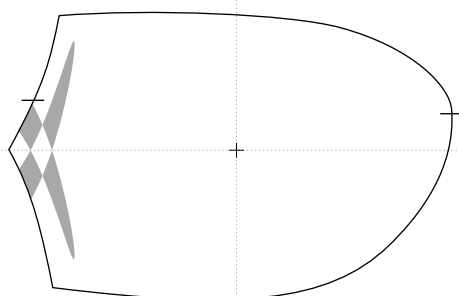

0 mm

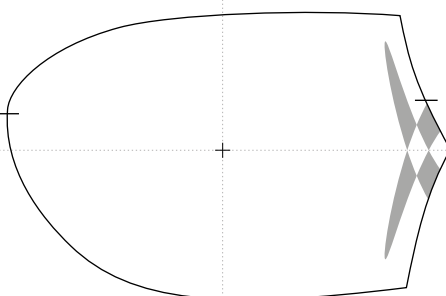

ZAIRA

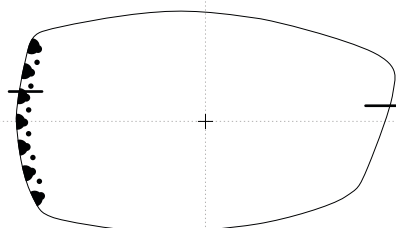

0,7 mm

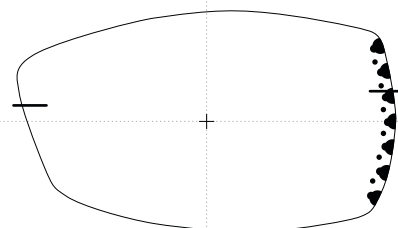

ZDENKA

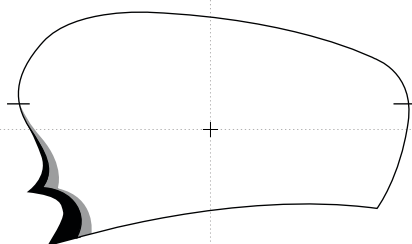

0 mm

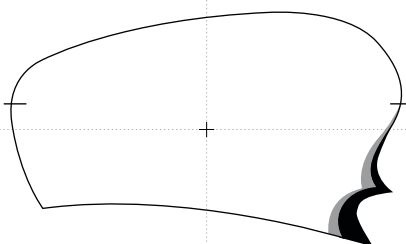

ZIKMUND

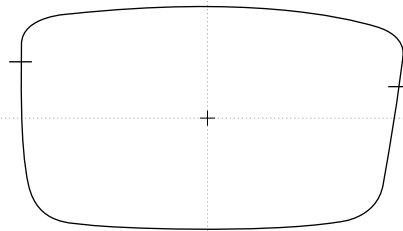

0,5 mm

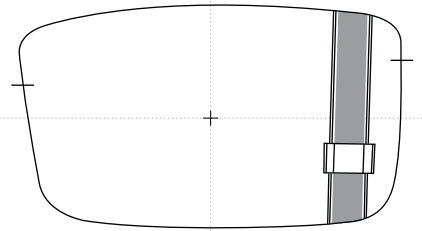

ZINA

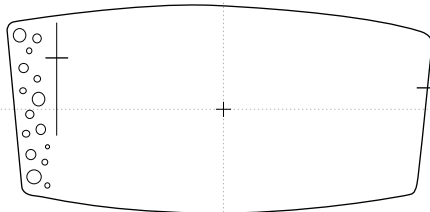

0,5 mm

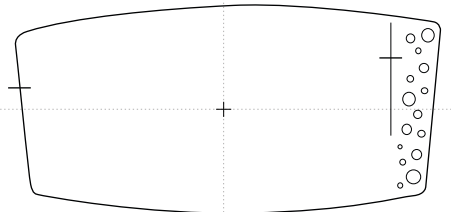

ZLATA

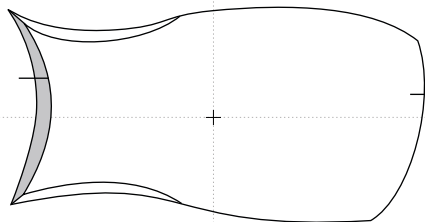

0 mm

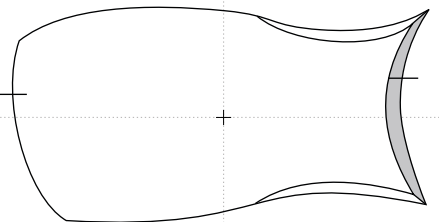

ZLATOVLASKA

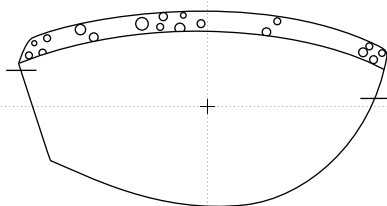

1 mm

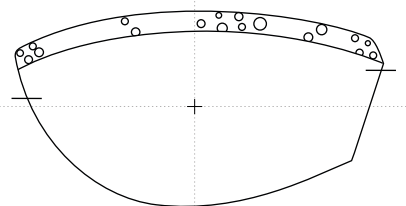



atelier
kreativ

ZOE

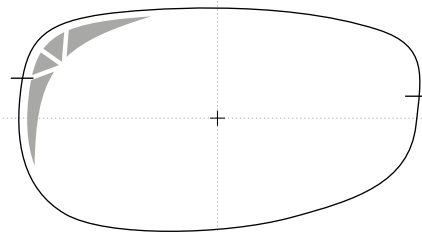

0 mm

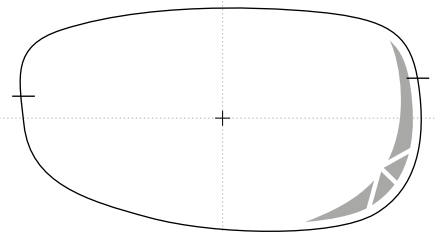

ZUZANA

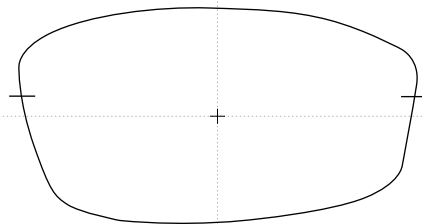

0,5 mm

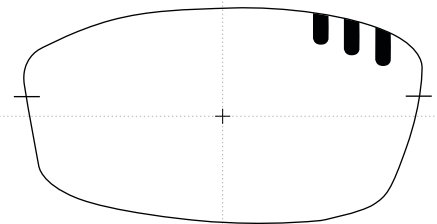

ZAKLINA

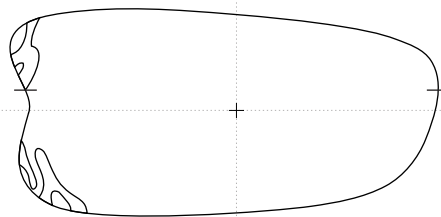

0 mm

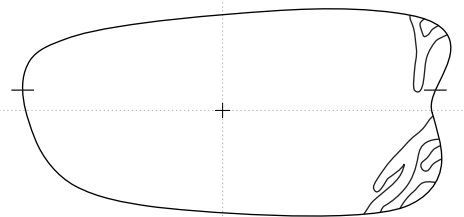

ZANETA

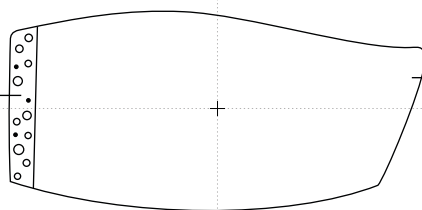

0 mm

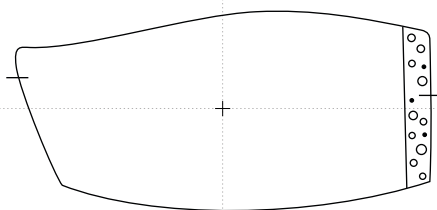

Tyto kreativní tvary brýlových čoček byly navrženy a vyrobeny v ateliéru kreativ při společnosti EYE 2000 s.r.o. a jsou chráněny Úřadem průmyslového vlastnictví jako průmyslový vzor.
These creative glasses lens shapes were designed and produced by atelier kreativ by EYE 2000 s.r.o. company and are patented and protected by the Authority of the Industrial Property.

EYE 2000 s.r.o. / Ohmova 271 / 109 00 Praha 10 / Czech Republic / Provozovna / Polubenská 614 / 468 61 Desná / Czech Republic
T +420 271 961 170 / www.eye2000.cz / info@eye2000.cz